

Instruction Manual (Installation)



Multi-loop module type Temperature Controller
Event Input/Output Module

Model : PUME

Fuji Electric Co., Ltd.

INP-TN1PUMeA-E

Thank you for purchasing the Fuji module type temperature controller. Once you have confirmed that this is the product you ordered, please use it in accordance with the following instructions. For detailed information on operating this equipment, please refer to the separate user's manual. In addition, please keep this instruction manual within easy reach of the actual person using this equipment.

CAUTION

The contents of this manual are subject to change without notice. This manual is compiled with possible care for the purpose of accuracy, however, Fuji Electric shall not be held liable for any damages, including indirect damage, caused by typographical errors, absence of information or use of information in this manual.

Confirming Specifications and Accessories

Before using the product, confirm that it matches the type ordered. (For model code, please refer to page 4.) Confirm that all of the following accessories are included.

Temperature Controller Event input/output Module	1 Unit
Instruction Manual	1 Copy

Related Information

Refer to "Module Type Temperature Controller Event Input/Output Module User's Manual" for details about the items described in this manual.

Content	Material name	Material No.
Specification	Catalog	ECNO 1162
Operating instruction	Event Input / Output module User's manual	INP-TN5A0199-E
Tool	PUM parameter loader	INP-TN5A0201-E

Please Read First (Safety Warnings)

Please read this section thoroughly before using and observe the mentioned safety warnings fully. Safety warnings are categorized as "Warning" or "Caution".

	Improper use of the equipment may result in death or serious injuries.
	Improper use of the equipment may cause injury to the user or property damage.

1 Warning

1-1 Installation and Wiring

• This equipment is intended to be used under the following conditions.	
Ambient temperature	-10 to 50 degree C
Ambient humidity	90% RH or below (with no condensation)
Vibration	10 to 70Hz less than 9.8m/s ² (1G)
Warm-up time	30 min. or more
Installation category	IEC1010-1: class II
Pollution level	IEC1010-1: degree 2

• Note that the insulation class for this equipment is as follows. Before installing, please confirm that the insulation class for equipment meets usage requirements.

Power	DI1-4
Loader communication	DI5-8
RS-485 communication	DO1-4
	DO5-8

==== Functional insulation (1000Vac)

—— Functional insulation (500Vac)

- In cases where damage or problems with this equipment may lead to serious accidents, install appropriate external protective circuits.
- To prevent damage and failure of the equipment, provide the rated power voltage.
- To prevent electric shock and equipment failure, do not turn the power ON until all wiring is complete.
- Before turning the power ON, confirm that clearance space has been secured to prevent shock or fire.
- Do not touch the terminal while the machine is ON. Doing so risks shock or equipment errors.
- Never disassemble, convert, modify or repair this equipment. Doing so risks abnormal operation, shock or fire.

1-2

Maintenance

- When installing or removing the equipment, turn the power OFF. Otherwise, shock, operational errors or failures may be caused.
- Periodic maintenance is recommended for continuous and safe use of this equipment.
- Some parts installed on this equipment have a limited life and/or may deteriorate with age.
- The warranty period for this unit (including accessories) is one year, if the product is used properly.

2

Caution

2-1

Cautions when Installing

Please avoid installing in the following locations.

- Locations in which the ambient temperature falls outside the range of 0 to 50 degrees C when equipment is in use.
- Locations in which the ambient humidity falls outside the range of 45 to 85% RH when equipment is in use.
- Locations with rapid temperature changes, leading to dew condensation.
- Locations with corrosive gases (especially sulfide gas, ammonia, etc.) or flammable gases.
- Locations with vibration or shock directly.
- Locations in contact with water, oil, chemicals, steam or hot water. (If the equipment gets wet, there is a risk of electric shock or fire, so have it inspected by Fuji distributor.)
- Locations with high concentrations of atmospheric dust, salt or iron particles.
- Locations with large inductive interference, resulting in static electricity, magnetic fields or noise.
- Locations in direct sunlight.
- Locations that build up heat from radiant heat sources, etc.

2-2

Cautions when Mounting to Cabinets / DIN rails

- In case of mounting the temperature controllers to DIN rails, remember to push up the locking tabs to fasten the controllers onto DIN rail.
- To connect controllers, first release all locking tabs. Then, connect controllers and push up all locking tabs. Make sure that all locking tabs are fastened.
- Never fail to turn the power OFF, before detaching the terminal block or removing the main unit from the base part.
- In order to aid heat dissipation, do not block the top and the bottom of the equipment.
- When mounting / dismantling controllers to / from DIN rails, 30mm of clearance above and under the controllers should be provided.

2-3

Cautions for Wiring

- Input signal wire and output signal wire should be separated from each other. And both should be shielded.
- If the output operation frequency is high, selecting a SSR/SSC drive output type is recommended. [Proportionate cycles] Relay output: 30 sec. or more, SSR/SSC drive output: 1sec. or more
- When inductive loads such as magnetic opening/closing equipment, etc. as relay output equipment are connected, use of "Z-trap," manufactured by Fuji Electric Device Technology Co., Ltd., is recommended in order to protect the contacts against opening/closing surges and to ensure long-term use.
 - Model names : ENE241D-07A (For 100V power voltage)
 - : ENE471D-07A (For 200V power voltage)
 - Attachment position : Please connect between the relay control output contacts.
- To comply with CE marking (EMC), we recommend to attach ferrite core to communication cable and power cable.
- For wiring to the terminal block, apply crimp type terminals size M3.
 - Screw size : M3 x 7 (with square washer)
 - Screw tightening torque : 0.78N-m (8kgf-cm)
- To avoid the influence of inductive noise, input signal wires should be separated from electric power lines or load lines.

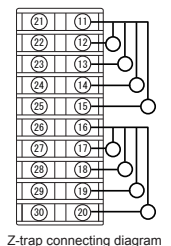

Z-trap connecting diagram

2-4

Error Operation

- The alarm function does not work properly when an error occurs unless the settings are made correctly. Always verify its setting before operation.

2-5

Others

- Please do not wipe the equipment with organic solvents such as alcohol or benzene, etc. If wiping is necessary, use a neutral cleaning agent.
- Do not use mobile phones near this equipment (within 50cm). Otherwise a malfunction may result.
- Malfunctions may occur if the equipment is used near a radio, TV, or wireless device.
- This equipment requires approx. 20 seconds before it starts to output.
- Before installing and wiring, take necessary measures for electrostatic discharge (ESD).

Part names and functions

- Event input/output module controller

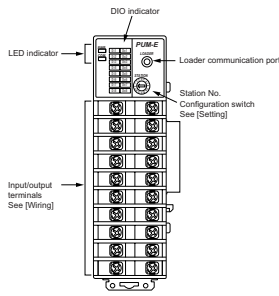

LED indicator

LED lamps indicate the following operational conditions.

LED	GREEN	RED	ORANGE
PWR	RUN	Error	-
COM	RS-485 receiving	-	RS-485 transmitting
Di1- 8	Digital inputting		
Do1- 8	Digital outputting		

- Actions to be displayed for COM, Di1-8 and Do1-8 can be allocated by programming.

- Base part

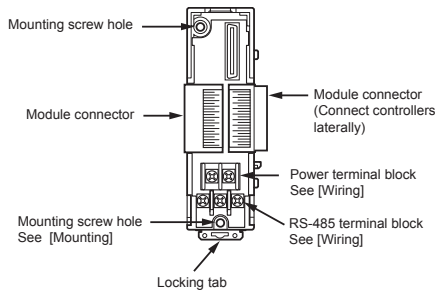

Setting

- Setting Station No.

Set Station No. of each controller before mounting.

Apply a fine tip flat-head screwdriver to turn the Station No. configuration switch.

Rotary SW setting	Station No.
0	17
1	18
2	19
3	20
4	21
5	22
6	23
7	24
8	25
9	26
A	27
B	28
C	29
D	30
E	31
F	32

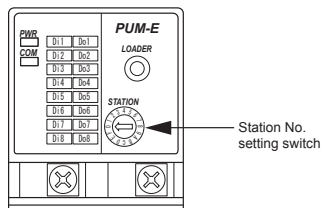

- Each of connected controllers must have a different Station No. from other controllers. Duplicate Station No. may cause malfunction of the equipment.

Mounting

- Dimensions

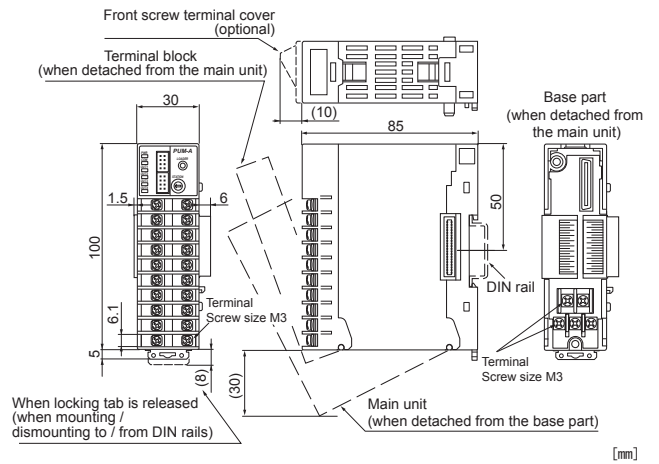

Cautions when mounting

In order to aid heat dissipation, 30mm of clearance (50mm recommended) above and under the controllers should be provided.

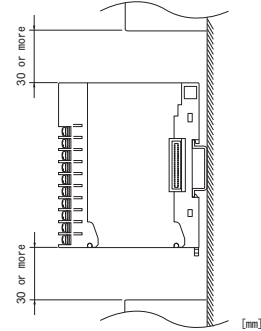

- Mounting to DIN rails

1. Pull down the locking tab of the base part. Hook the back of the controller onto the upper part of DIN rail.
2. Push the controller in the direction of arrow 2.

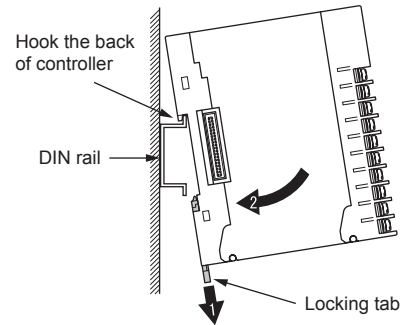

3. Push up the locking tab to fasten the controller onto DIN rail.
4. When connecting controllers after mounting to DIN rail, push up the locking tab after doing so.

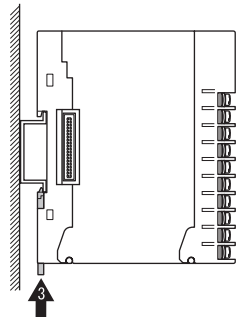

- Attaching end plates

When mounting controllers to DIN rails, we recommend to attach side connecting terminal covers (right and left 1 set), then end plates (optional) to the ends of the rightmost and leftmost controllers.

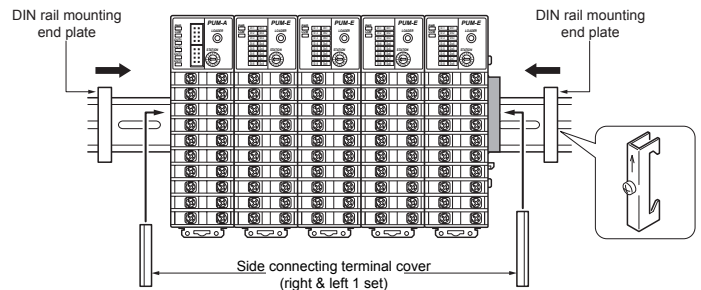

- Fixing with screws

When mounting controllers inside a cabinet with screws, connect the base parts of controllers first.

- Fixing screws are not included. Please prepare screws as required.

1. Refer to the figure below for the mounting screw hole size to decide the mounting position.

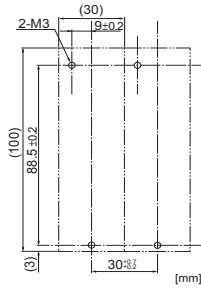

2. Remove the main unit from the base part. See [How to detach the base part]
3. Connect base parts. Push up to fasten all the locking tabs.
4. Fixate the base parts onto the mounting position inside the cabinet with screws.
5. Attach the main unit to the base parts.

- Connecting controllers

1. Check that locking tabs are pulled down (released).
2. Connect controllers with each other using side connectors.

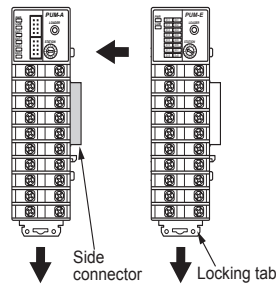

3. After mounting controllers onto DIN rail, make sure to push up all locking tabs. Controllers are fastened to DIN rail and to each other.
4. All connected controllers are connected to power supply and RS-485 via side connectors if one of controllers is directly connected to them.

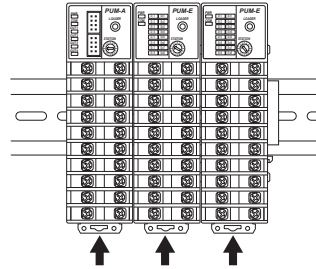

- Front terminal block

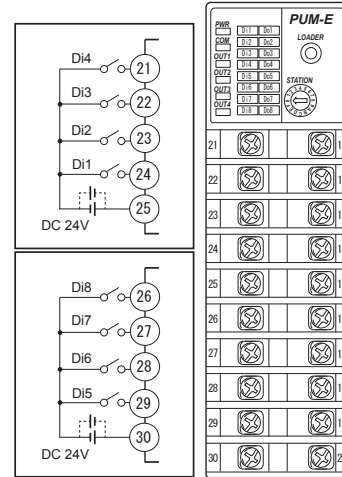
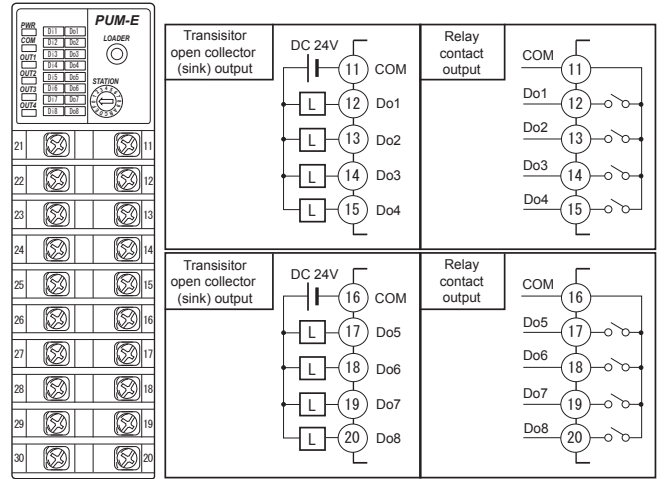

- Base part (power terminal, RS-485 terminal)

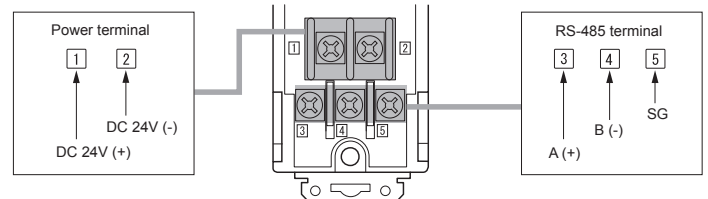

*All connected controllers are connected to power supply and RS-485 via side connectors if one of controllers is directly connected to them.

How to detach the base part

1. Press the lock lever on the top of the main unit.
2. Pull down the upper part of main unit.
3. Detach the cutout on the lower end of back of main unit from the projection on the base part.

- When attaching the main unit to the base part, take the reverse procedure to removing the main unit from the base part.
- Make sure that the lock lever of the main unit is fitted into the base part.

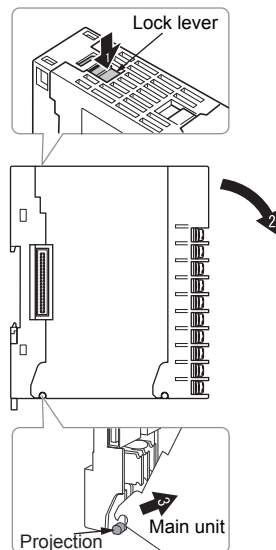

Specification

General Specification

Power Supply	: 24Vdc±10%
Power Consumption	: Maximum 3.2W (135mA) [when 24Vdc is applied]
Dimensions	: 30(W)×100(H)×85(D) mm (excluding terminal cover and projection)
Weight	: Approx. 200g
Installation method	: DIN rail mounting or mounting with M3 screws inside a cabinet
Ambient temperature*	: -10 to 50 degrees C
	* "Ambient temperature" is the temperature underneath the controller inside the equipment or the cabinet where the controller is installed.
Ambient humidity	: 90% RH or less (non condensing)

Digital input

No. of input	: 8 points (4 points / common × 2 blocks)
Input type	: Voltage contact input, sink / source common (bidirectional)
Input rating	: 24Vdc, Input impedance approx. 4.7k ohm
Input judgment	: ON judgment : 16 to 26.4Vdc
	: OFF judgment : 0 to 5Vdc
Input read cycle (min. pulse width):	200ms

Digital output

No. of output	: 8 points (4 points / common × 2 blocks)
Output type, rating	: Select from a) and b) according to the model specification
a) Relay contact output	
- Contact structure	: SPST contact
- Contact capacity	: 220Vac / 30Vdc, 1A
b) Transistor open collector (sink output)	
- Rating	: 24Vdc, 100mA (residual voltage when ON : 1.5Vdc or less)

Communication function

RS-485 interface	
Communication standard	: RS-485
No. of ports	: 1 port
Communication, synchro method	: Two-wire, half-duplex, asynchronous cycle
Communication speed	: 9.6k, 19.2k, 38.4k, 115.2kbps
Data form	: data bit ; 8, parity ; even / odd / none
Communication distance	: 1km (38.4kbps or less), 250m (115.2kbps)
Connectable units	: 33 units (both master and slave units included)
	(32 units if any modules other than PUM series is included in slaves)
Protocol	: Modbus RTU compatible
Loader (RS-232C) interface	
Communication standard	: RS-232C
No. of ports	: 1 port
Communication, synchro method	: Half-duplex, asynchronous cycle
Communication speed	: 19.2 kbps (fixed)
Data form	: data bit 8, no parity
Protocol	: Modbus RTU compatible

Crimp terminal size

Please prepare power cables and crimp terminals of the size indicated below.

Power cable

Cable type	Size
Thermocouple (Compensation lead wire)	1.25mm ² or less
Power supply	1.25mm ² or less

Crimp terminal

Cable size	Screw tightening torque
0.25 to 1.25mm ²	0.8Nm

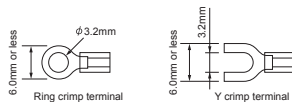

Model code

Event Input/Output module

1	2	3	4	5	6	7	8	9	10	Description
P	U	M			Y	Y	1	0		Module type
										Event input/output module [Di 8 points/Do 8 points]
										Output type (Event input/output module)
										Open collector output
										Relay contact output
										Instruction manual
										A Japanese
										B English

Accessories (optional)

1	2	3	4	5	6	7	8	Description
P	U	M	Z	*				A 0 1 RS-485 terminating resistance
								A 0 2 DIN rail mounting end plate
								A 0 3 Side connecting terminal cover (right & left 1 set)
								A 0 4 Front face screw terminal cover
								L 0 1 Loader connecting cable (RS-232C)

Fuji Electric Co., Ltd.

International Sales Div Sales Group

Gate City Ohsaki, East Tower, 11-2, Osaki 1-chome,
Shinagawa-ku, Tokyo 141-0032, Japan
http://www.fujielectric.com
Phone: 81-3-5435-7280, 7281 Fax: 81-3-5435-7425
http://www.fujielectric.com/products/instruments/