



**DIGITAL CONTROLLER  
<MICRO CONTROLLER X>  
COMMUNICATION  
FUNCTION  
(RS-485 MODBUS)**

MODEL : PXF



---

# Introduction

Thank you for purchasing the Fuji Digital Temperature Controller.

This document describes how to connect the Micro controller PXF Series (referred to below as "Micro controller") to the personal computer or programmable controller. It also describes communication specifications for controlling and monitoring the communications with the micro controller, MODBUS protocol, and address map for the micro controller.

In addition to this document, please make sure to read the Instruction Manual (which comes with the product) and the Operations Manual (packaged separately).

## NOTE

### ■ Exclusions

The contents of this document may change without prior notice.

Although great care has been taken in the accuracy of this document, Fuji Electric takes no responsibility for loss or indirect damages caused by mistakes, missing information, or use of information in this document.

# Contents

## 1. Communication Functions

Overview.....	4
Connecting to a programmable controller .....	5
Connecting to a personal computer .....	5

## 2. Specifications

Communication Specifications .....	8
RS-485.....	8
PC Loader Interface .....	8

## 3. Connection

Communication Terminal Configuration.....	10
Wiring .....	11

## 4. Setting Communication Parameters

List of Setting Parameters .....	16
Parameter Setting Procedure .....	17

## 5. MODBUS Communication Protocol

Overview.....	20
Message Composition .....	21
Calculating Error Check Code (CRC-16).....	24
Transmission Control Steps.....	25
Precautions when Writing Data.....	26

## 6. Command and Transmission Frame Details

Reading Data .....	28
Writing Data.....	32

## 7. Address Map and Data Format

Data Format.....	38
Internal Calculation Value Data Address Map .....	40

## 8. Sample Program

Sample Program.....	68
---------------------	----

## 9. Cooperative operation

Overview .....	70
Connection.....	71
Setup and related parameters .....	72
Cooperative operation.....	73
List of parameters subject to the cooperative operation .....	74

## 10. Programless communication

Overview .....	82
Connection.....	83
Programless communication.....	84
Setup and related parameters .....	88
Setup for Programless Communication .....	90

## 11. Troubleshooting

Troubleshooting.....	126
----------------------	-----

# **Chapter 1**

## **Communication Functions**

Overview – 4

# Overview

- The micro controller is equipped with communication functions from the RS-485 interface and PC loader interface, which enables the transmission and reception of data between such devices as the personal computer, programmable controller, and graphic panel.
- The version with RS-485 communication can provide the following three functions.

1. MODBUS RTU communication	Typical master/slave communication is available. A PC or PLC acts as a master, while multiple temperature controllers act as slaves. Communication is made in such a way that the master sends messages to the slaves, and the slaves respond to it.
2. Cooperative operation	When you control one temperature controller, the other controllers follow it. The one controller acts as a master, while other controllers act as slaves. When you change the settings of the master controller, a message will be sent to all slave controllers which follow the change.
3. Programless communication	Programmable controller (PLC) can read the data of temperature controllers or write data on temperature controllers without preparing a rudder program. One PLC acts as a master, and multiple temperature controllers act as slaves. Each temperature controller in turn carries out master-slave communication with PLC. The communication protocol is MODBUS RTU.

The following is the description for MODBUS RTU communication. For cooperative operation and programless communication, refer to Chapter 9 "Cooperative operation" and/or Chapter 10 "Programless communication".

- The communication system is composed of a master and slave relationship. Up to thirty-one slaves (micro controllers) may be connected to one master (such as a personal computer) based on a "single master/multiple slave" method.
- However, the master can only communicate with one slave at a time. Therefore, each slave is specified by the "Station No." setting. With PC loader communication, only one slave can be connected to one master.

**Caution**

- Systems constructed with the micro controller as slaves do not respond to messages issued by the master with broadcast queries where the station number is "0".
- PC loader communication is not compatible with the multiple slave method.

- In order to have proper communication between master and slave, the transmission data must be in the same format. This document explains how to transmit data using the MODBUS protocol format.
- When using equipment with an RS-232C interface, such as a personal computer, as the master, make sure to use an RS-232C to RS-485 converter.
- When using PC loader communication, you can use communication with the personal computer by connecting the PC loader interface on the bottom of this unit with the PC loader communication cable (model: ZZP\*TQ501923C3) sold separately.

**RS-232C to RS-485 converter (recommended product)**

Model	Manufacturer	URL	Baud rate
KS3C-10 (isolated type)	OMRON Corporation	<a href="http://www.omron.co.jp">http://www.omron.co.jp</a>	Maximum 38400 bps
SI-30FA (isolated type)	LINEEYE Co., Ltd.	<a href="http://www.lineeye.co.jp">http://www.lineeye.co.jp</a>	Maximum 115.2 Kbps

## Connecting to a programmable controller

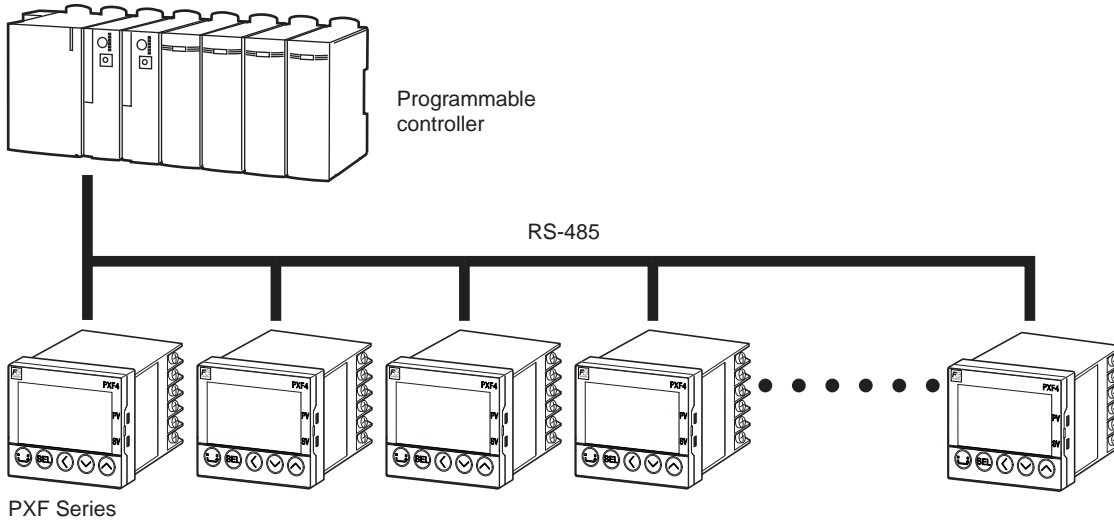

## Connecting to a personal computer

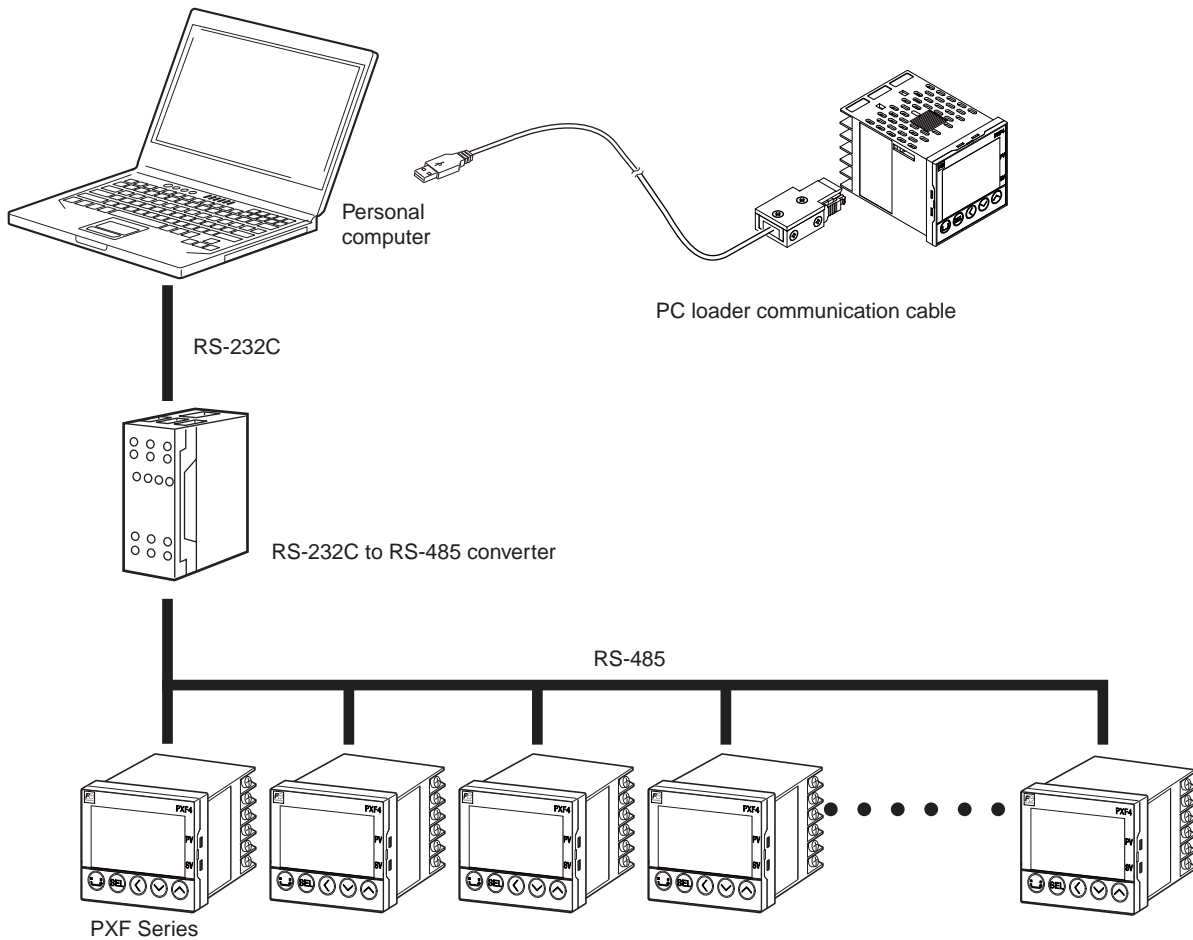

### Caution

When using the RS-232C to RS-485 converter, check to make sure that the cable is properly connected between the converter and master. Communication will not work properly if the connection is incorrect.

Also be sure to correctly set the communication settings (such as communication speed and parity) on the RS-232C to RS-485 converter. Communication will not work properly if the settings are incorrect.

# **Chapter 2**

## **Specifications**

**Communication Specifications – 8**



# Communication Specifications

## RS-485

Item	Specifications	
Electrical specifications	EIA RS-485 compliant	
Communication method	Two wire system, half double-bit serial	
Synchronous method	Asynchronous	
Connection status	1:N	
Max. no. of connections	31 units	
Communication distance	Max 500m (total length)	
Communication speed	9600bps, 19200 bps, 38.4kbps, 115.2kbps	
Data format	Data length	8 bits
	Stop bit	1 bit
	Parity	None/Even/Odd (Selectable)
Transmission code	HEX value (MODBUS RTU mode)	
Error detection	CRC-16	
Insulation	Functional insulation for the transmission area and other areas (withstanding AC 500V)	

## PC Loader Interface

Item	Specifications	
Electrical specifications	TTL Level	
Communication method	3wire system, half double-bit serial	
Synchronous method	Asynchronous	
Connection status	1:1	
Station No.	1 (Not to be changed)	
Communication speed	38.4kbps (Not to be changed)	
Data format	Data length	8 bits
	Stop bit	1 bit
	Parity	none (Not to be changed)
Transmission code	HEX value (MODBUS RTU mode)	
Error detection	CRC-16	
Insulation	Non-insulated internal circuit	

# Chapter 3

## Connection

Communication Terminal Configuration – 10

●  
Wiring – 11

## ⚠ Warning

Do not turn on power until all of the wiring is completely finished.  
There is a risk of electrical shock or damage.

# Communication Terminal Configuration

## ■ RS-485 (rear terminal)

### PXF4

Terminal Number	Signal Name
7	RS-485 +
8	RS-485 -

1	7	13
2	8	14
3	9	15
4	10	16
5	11	17
6	12	18

### PXF5, PXF9

Terminal Number	Signal Name
25	RS-485 +
26	RS-485 -

1		25
2		26
3		27
4		28
5		29
6		30
7		31
8		32
9		33
10		34
11		35
12		36

## ■ PC Loader Interface

### PXF4

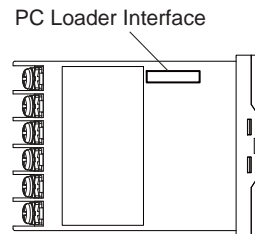

### PXF5

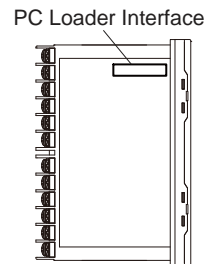

### PXF9

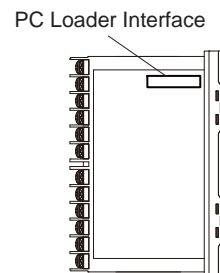

# Wiring

## ■ RS-485

- Please use a shielded twist pair cable. (Recommended cable: KPEV-SB (made by The Furukawa Electric Co., Ltd.))
- The maximum cable length should be 500m. One master and up to thirty-one micro controllers (slaves) can be connected per circuit.
- Terminate both ends of the circuit with a terminating resistance of  $100\Omega$  (1/2W or more).
- Ground the shielded cable once towards the master side.

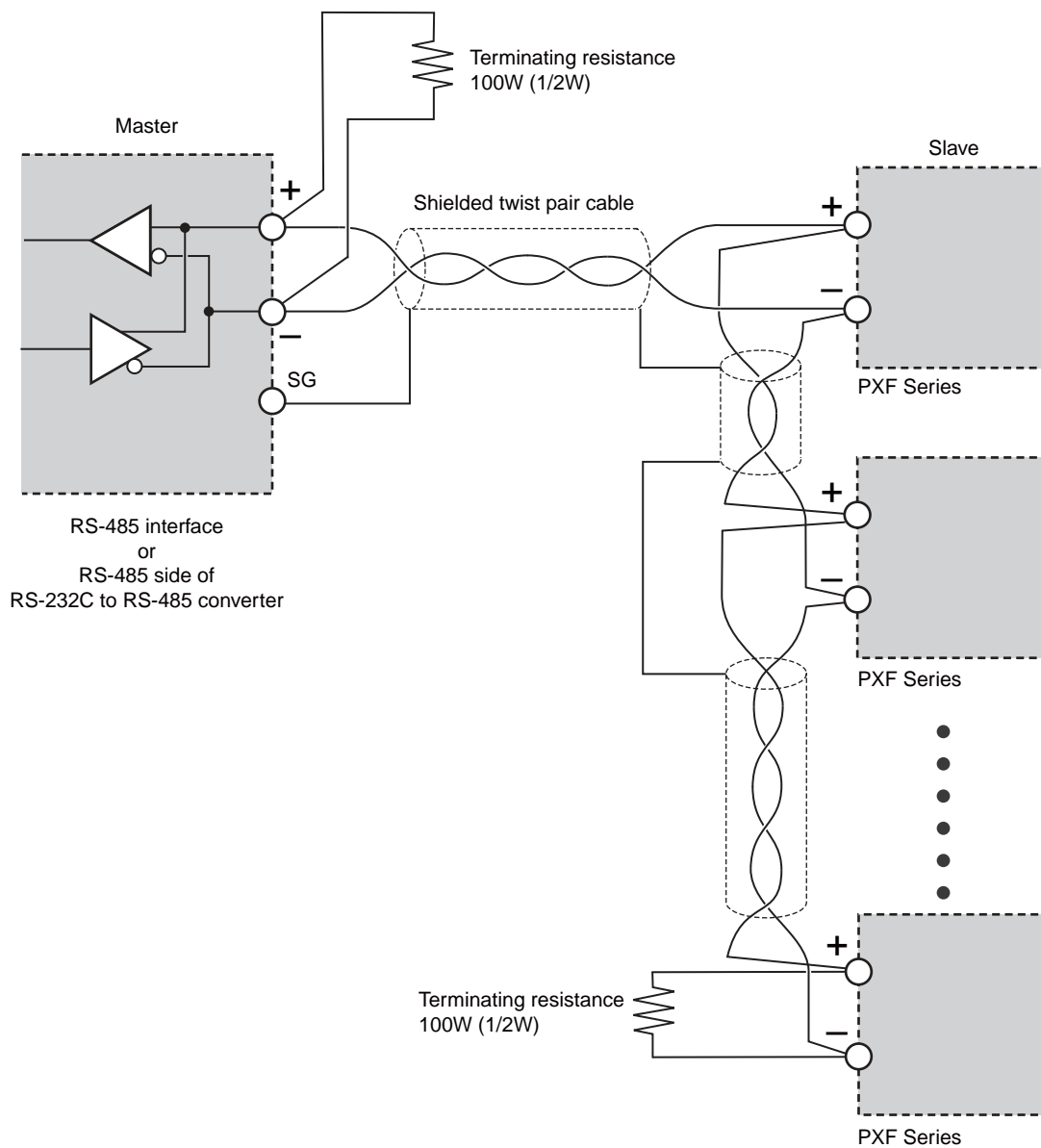

- SG does not have to be connected, but it can be used as an effective countermeasure against communication errors due to noise.

- When using the micro controller in an area where the imposed noise level is expected to exceed 1000V, we recommend using a noise filter on the master side as seen in the figure below.

[Noise filter] (recommended): ZRAC2203-11 (made by TDK Corporation)

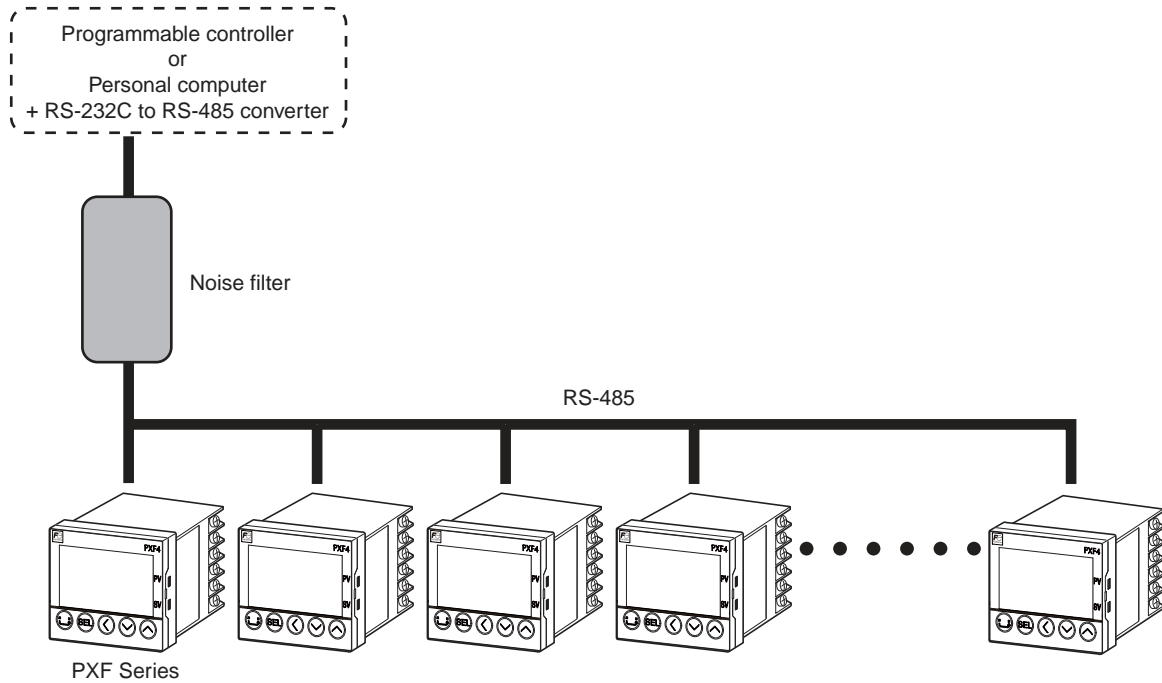

- If there are problems with EMC during communication, the noise level can be reduced by using a communication cable with a ferrite core.

Ferrite core (recommended): ZCAT series (made by TDK Corporation)

MSFC series (made by Morimiya Electric Co., Ltd.)

## ■ PC Loader Interface

- Use the PC loader communication cable sold separately.

### PXF4

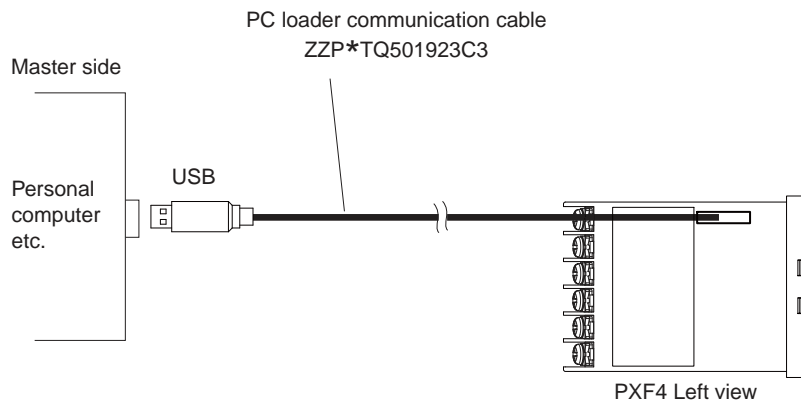

### PXF5

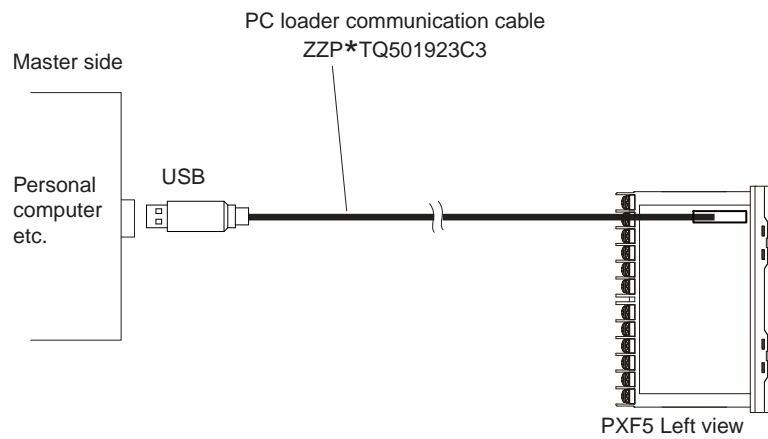

### PXF9

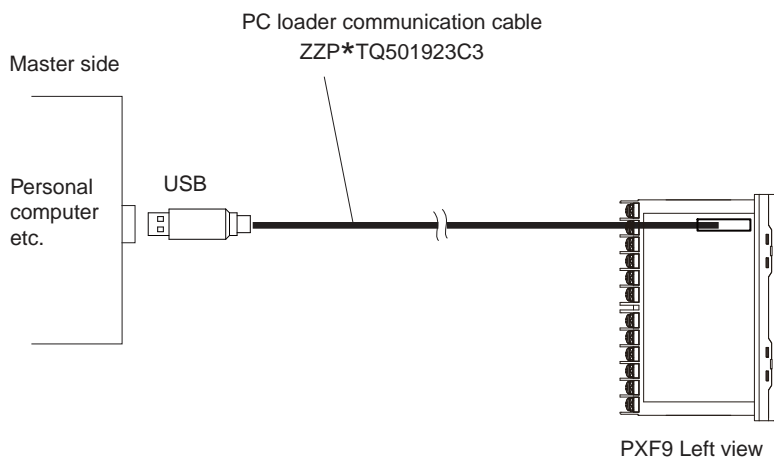

# Chapter 4

## Setting Communication Parameters

List of Setting Parameters – 16

Parameter Setting Procedure – 17

The following settings are required for proper communication between the master and micro controller units.

- The communication parameters for the master and all of the units must be set the same.
- During RS-485 communication, all of the micro controllers on a circuit must be set with different "Station No. (STno)" other than "0 (zero)". (Multiple micro controllers must not have the same "Station No.".)
- When using the PC loader interface, settings are not necessary on the main unit (the micro controller).

## List of Setting Parameters

The setting parameters are shown in the chart shown below. Change the settings using the keys on the front of the micro controller.

### ■ RS-485 (controller side)

Parameter channel	Screen No.	Parameter display symbol	Name	Setting range	Initial value	Remarks
CoM CH9	760	CTYP	Communication type	0: MODBUS RTU 1: Cooperative operation 2: Programless communication	0	Select "0: MODBUS RTU".
	761	StNo	Station No.	0 to 255 (0: unresponsive communication)	1	Sets the station number.
	762	SPEd	RS-485 baud rate	96: 9600 bps 192: 19200 bps 384: 38400 bps 115K: 115 Kbps	96	Sets the baud rate
	763	PRty	RS-485 parity	none odd even	odd	Sets the parity check
	764	iNtV	RS-485 response interval	0 to 100	1	Widen the time interval of receiving response. (Set value x 20 ms)
	767	SCC	Communication permissions	r: read only rW: read/writable	rW	Sets whether or not overwriting is possible from the master side (PC, etc.)
	–	–	Data length	Fixed (cannot be changed)	8 bits	Set the master and all of the slaves with the same settings.
	–	–	Stop bit	Fixed (cannot be changed)	1 bits	Set the master and all of the slaves with the same settings.

### ■ Loader interface (main unit side)

The parameters do not need to be set. Set the loader software (master) with the following settings.

- Communication speed: 38400 bps
- Parity: none



# Parameter Setting Procedure

The following steps explain how to change the settings to station number "3", parity setting "9600bps/none", and communication permissions "read and writable" as an example.

- 1** Press and hold the **SEL** key to move to "channel selection mode".

CH 1
Pid
- 2** Use the **▲ ▼** keys to select "CoM CH9".

CH 9
CoM
- 3** Press the **SEL** key to display "StNo".

StNo
0
- 4** Press the **SEL** key, and when the bottom part of the display begins to blink, use the **▲ ▼** keys to select "3".  
The station number "3" is selected.

StNo
"3"
- 5** Press the **SEL** key to set.
- 6** Use the **▲ ▼** keys to select "SPEd".

SPEd
96
- 7** Press the **SEL** key, and when the bottom part of the display begins to blink, use the **▲ ▼** keys to select "96".  
The RS-485 baud rate is set to "9600 bps".

SPEd
"96"
- 8** Press the **SEL** key to set.
- 9** Use the **▲ ▼** keys to select "PRty".

PRty
odd
- 10** Press the **SEL** key, and when the bottom part of the display begins to blink, use the **▲ ▼** keys to select "NoNE".  
The RS-485 parity is set to "none".

PRty
"NoNE"
- 11** Press the **SEL** key to set.
- 12** Use the **▲ ▼** keys keys to select SCC ("SCC").

SCC
R
- 13** Press the **SEL** key, and when the bottom part of the display begins to blink, use the **▲ ▼** keys to select "WR".  
Communication permissions is set to "read/writable".

SCC
"WR"

---

**14** Press the  key to set.

**15** Press the  key to return to the operation mode PV/SV screen.

**16** Turn the power to the micro controller off and on again.  
The changes to the communication parameters become effective after the power turns off and on again.

# Chapter 5

## MODBUS Communication Protocol

Overview – 20



Message Composition – 21



Calculating Error Check Code (CRC-16) – 24



Transmission Control Steps – 25



Prercautions when Writing Data – 26

# Overview

The communication system with the MODBUS protocol always operates using a method where the master first sends a command message and the applicable slave replies with a response message.

The following describes the communication steps.

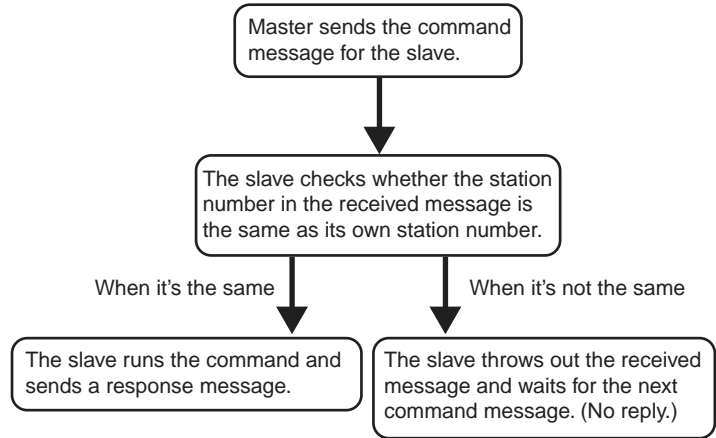

- When the station number in the command message is the same as the unit's station number

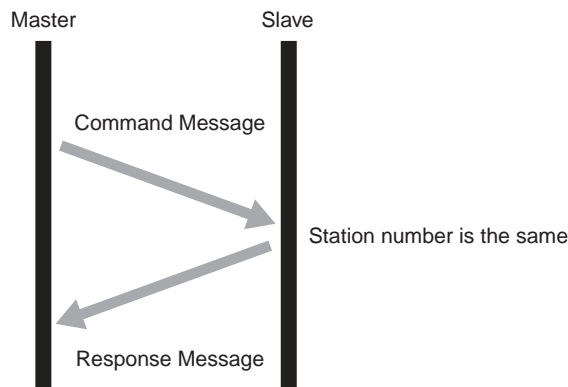

- When the station number in the command message is not the same as the unit's station number

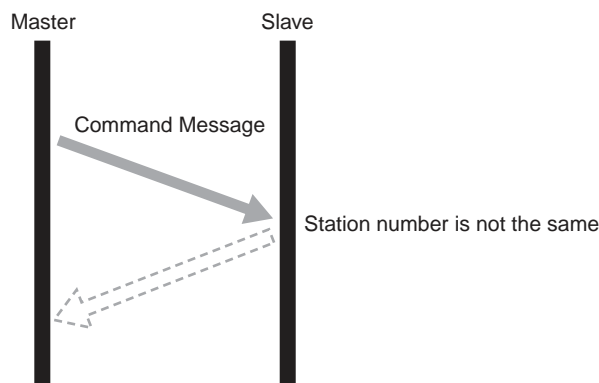

The master can communicate with an individual slave when multiple slaves are connected on the same circuit by the station number specified in the master's command message.

# Message Composition

The command message and response message are composed of four parts: the station number, function code, data part, and error check code. These four parts are sent in that order.

Field name	No. of bytes
Station No.	1 byte
Function Code	1 byte
Data Part	2 to 125 bytes
Error Check Code (CRC-16)	2 bytes

The following describes each part of the message.

## Station No.

This is the number specifying the slave. Commands can only be processed by slaves that have the same value set in the "STno" parameter.



For more about setting the "STno" parameter, see "Chapter 4, Setting Communication Parameters" (p. 15).

## Function Code

This code specifies the function for the slave to perform.



For more about function codes, see "Function Code" (p. 23).

## Data Part

This data is required to run the function code. The composition of the data part is different depending on the function code.



See "Chapter 6, Command and Transmission Frame Details" (p. 27).

The data in the micro controller is assigned a coil number or resistor number. This coil number or resistor number is specified when the data is read or written through communication.

The coil number or resistor number used by the message employs a relative address.

The relative address is calculated using the following formula.

**Relative address = (last four digits of the coil number or resistor number) – 1**

(Ex.) When a function code specifies resistor number "40003"

$$\begin{aligned} \text{Relative address} &= (\text{the last four digits of } 40003) - 1 \\ &= 0002 \end{aligned}$$

is used in the message.

## Error Check Code

This code detects whether there are errors (changes in the bits) during the signal transmission processes. MODBUS protocol (RTU mode) uses CRC-16 (Cyclic Redundancy Check).



For more about calculating CRC, see Section 5, "Calculating Error Check Code (CRC-16)" (p. 24).

## Slave Response

### ■ Normal Slave Response

The slave creates and replies with a response message for each command message. The response message has the same format as the command message.

The contents of the data part are different depending on the function code.



See "Chapter 6, Command and Transmission Frame Details".

### ■ Irregular Slave Response

If there are problems (such as specification of a nonexistent function code) with the contents of the command message other than transmission error, the slave creates and replies with an error response message without following the command.

The composition of the error response message uses the value of the function code in the command message plus 80<sub>H</sub>, as seen below.

Field name	No. of bytes
Station No.	1 byte
Function Code + 80 <sub>H</sub>	1 byte
Error Code	1 byte
Error Check Code (CRC-16)	2 bytes

The error code is shown as follows.

Error Code	Contents	Explanation
01 <sub>H</sub>	Faulty function code	A nonexistent function code was specified. Please check the function code.
02 <sub>H</sub>	Faulty address for coil or resistor	The specified relative address for the coil number or resistor number cannot be used by the specified function code.
03 <sub>H</sub>	Faulty coil or resistor number	The specified number is too large and specifies a range that does not contain coil numbers or resistor numbers.
04 <sub>H</sub>	Write inhibited	Data writing via communication is prohibited. "SCC" parameter is set to "R: read only".
06 <sub>H</sub>	Busy	EEPROM is busy in writing. Wait for a few seconds, and then retry writing.

### ■ No Response

In the following situations, the slave will ignore the command message and not send a response message.

- The station number specified by the command message is not the same as the slave's specified station number.
- The error check code does not correspond, or a transmission error (such as parity error) is detected.
- The interval between the data comprising the message is empty for more than 24 bit time.



See Section 5 "Transmission Control Steps" (p. 25).

- The slave station number is set to "0".

## Function Code

For MODBUS protocol, coil numbers or resistor numbers are assigned by the function code, and each function code only works for the assigned coil number or resistor number.

The correspondence between the function code and the coil number or resistor number is as follows.

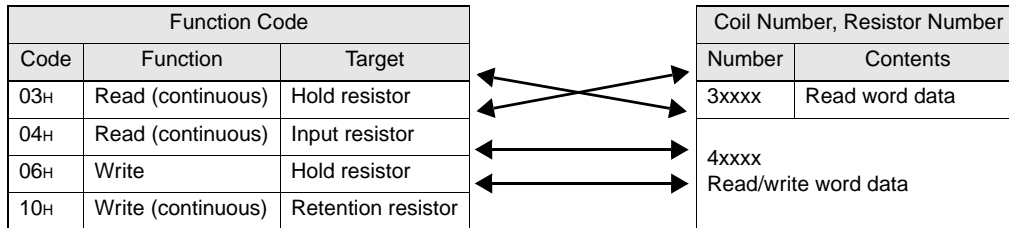

The message length for each function is as follows.

[unit: byte]

Code	Contents	Assignable Data Number	Command Message		Response Message	
			Minimum	Maximum	Minimum	Maximum
03H	Read word data	60 words <sup>*1</sup>	8	8	7	125
04H	Read word data (read-only)	60 words <sup>*1</sup>	8	8	7	125
06H	Write word data	1 word	8	8	8	8
10H	Continuously write word data	60 words <sup>*1</sup>	11	129	8	8

\*1: "Assignable Data Number" above is limited by the data number that the micro controller assigned to the coil number or address number.

(Excluding function code 06H).

# Calculating Error Check Code (CRC-16)

CRC-16 is a 2-byte (16-bit) error check code. The calculation range extends from the start of the message (station number) to the end of the data part.

The slave calculates the CRC of the received message and ignores the message if this value is not the same as the received CRC code.

CRC-16 is calculated as follows.

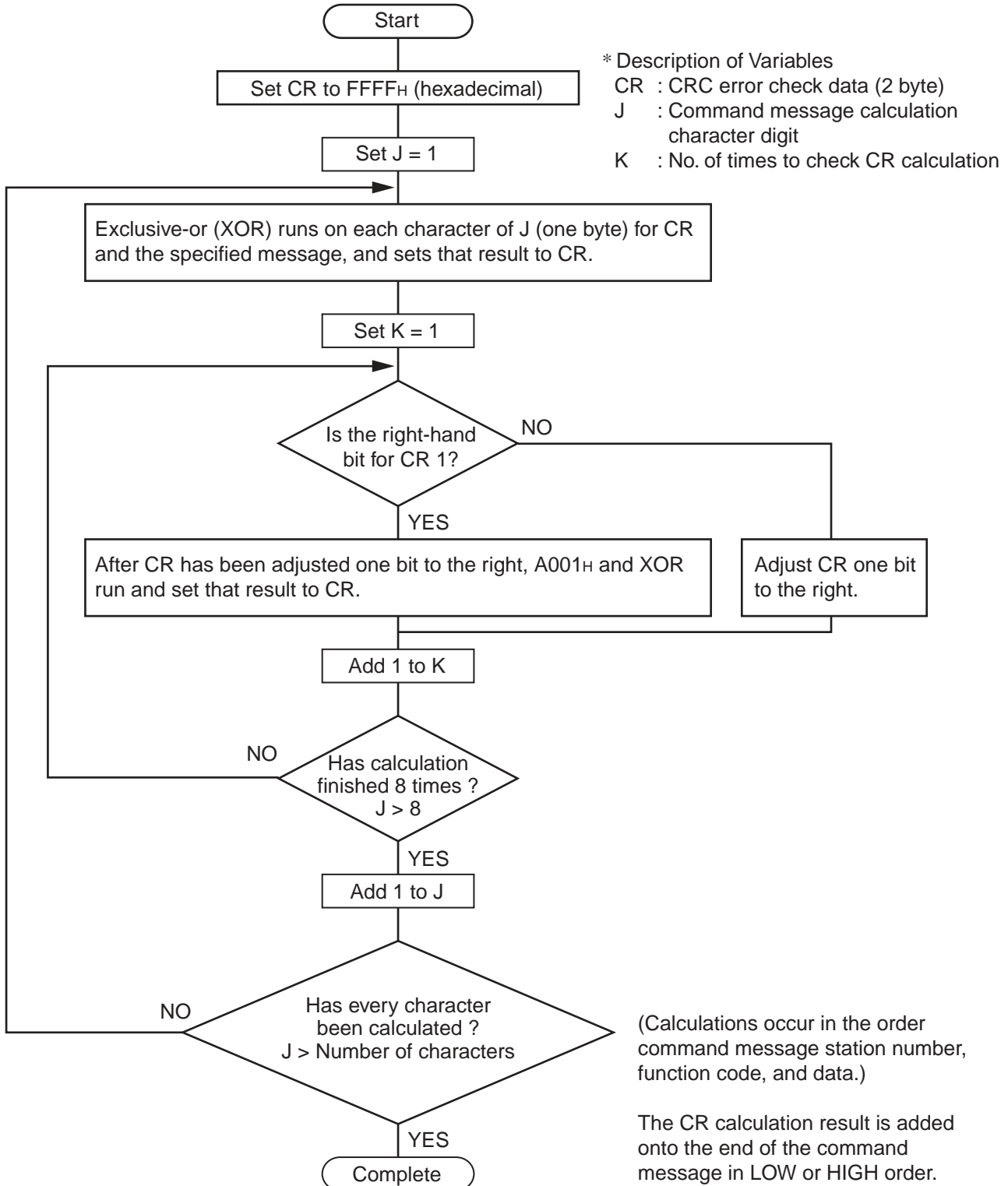



# Transmission Control Steps

## Master Communication Method

Start communication from the master while following the rules below.

1. The command message, must be sent after an empty space of at least 48 bit time.
2. The interval between each byte in a command message should be less than 24 bit time.
3. After sending a command message, for less than 24 bit time the master will enter receiving standby.
4. After receiving the response message, the next command message must be sent after at least 48 bit time. (Similar to #1.)
5. For safety reasons, create a framework where the master checks the response message, and if there is no response or an error occurs, retry at least three times.

### Caution

The definitions written above are for the minimum required value. For safety reasons, we recommend creating a master side program that keeps margins two to three times as large. For a concrete example, with 9600 bps, we recommend programming a blank state (#1 above) of at least 10ms, and the interval between bytes (#2 above) and switching time from sending to receiving (#3 above) within 1 ms.

## Explanation

### ■ Frame Detection

This communication system uses a two-wire RS-485 interface, and the circuit can therefore enter one of the following two states.

- Empty state (no data on the circuit)
- Communication state (data running on the circuit)

The units connected on the circuit start in receiving state and monitor the circuit. When a blank state appears on the circuit for at least 24 bit time, the unit detects the end of the previous frame, and within the next 24 bit time, enters receiving standby. When data appears on the circuit, the unit begins receiving data, and once another blank state of at least 24 bit time is detected, that frame is ended. In other words, the data on the circuit from the first time that a 24 bit time blank state appears to the second time one appears is loaded as one frame (a bundle of data). Therefore, one frame (command message) must be sent while following the rules below.

- Before sending the command message, leave an empty space of at least 48 bit time.
- The interval between each byte in a command message should be less than 24 bit time.

### ■ Micro controller Response

After the micro controller detects the frame (detects blank states at least 24 bit time long), that frame is used to send a command message. When a command message is sent locally, the response message is returned, but the processing time is about 1 to 30 ms. (The time may change depending on the contents of the command message. ) Therefore, one frame (command message) must be sent while following the rules below.

- After sending a command message, for less than 24 seconds the master will enter receiving standby.

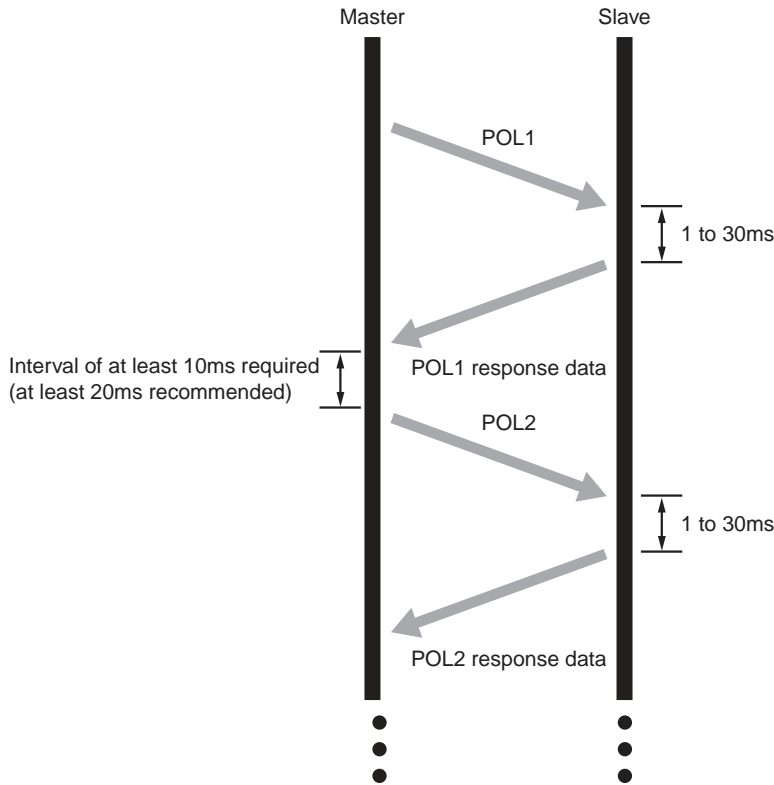

## Prercautions when Writing Data

PXF contains internal nonvolatile memory (EEPROM) that is used to save the setting parameters. The data written to the nonvolatile memory (EEPROM) remains even after the power for PXF is turned off. Parameters that are written via communication are automatically saved in the internal nonvolatile memory (EEPROM). However, please note that there are two limitations as follows.

**Caution**

1. There is a limit to the number of times that data can be transferred to the nonvolatile memory (EEPROM) (100,000 times). Data cannot be guaranteed if written more than 100,000 times.  
Be careful not to transfer unnecessary data when writing data via communication.  
In particular, when constructing a communication system with master POD (such as a touch panel), make sure that the POD writing and trigger settings are appropriate.  
Avoid writing at fixed cycles.
2. Writing to the nonvolatile memory (EEPROM) takes several milliseconds. If the power for PXF is turned off during this operation, the data saved to the nonvolatile memory (EEPROM) may be corrupted.  
Wait several seconds after writing data before turning off the power.  
In particular, when writing data in a cycle from master device, there is a greater danger of the writing timing and power shutoff timing coinciding.  
Avoid writing at fixed cycles.

# Chapter 6

## Command and Transmission Frame Details

Reading Data – 28



Writing Data – 32

# Reading Data

## Reading Word Data (Function Code: 03H)

The unit reads word data continuously for the specified number of words from the first number to start reading from. The slave forwards the read word data from the upper number of bytes to the lower number.

Function Code	03H	
Max. No. of Words to Read in One Message	60 words	
Relative Address	0000H to 07CFH	07D0H to 013AH
Resistor Number	40001 to 42000	42001 to 45032
Contents	Internal Calculation Value	Engineering Unit

### Message Composition

#### Command Message Composition (bytes)

Station No.	
Function Code	
No. to Start Reading (Relative Address)	Upper
	Lower
No. of Words to Read (1 to 60 words)	Upper
	Lower
CRC Data	Upper
	Lower

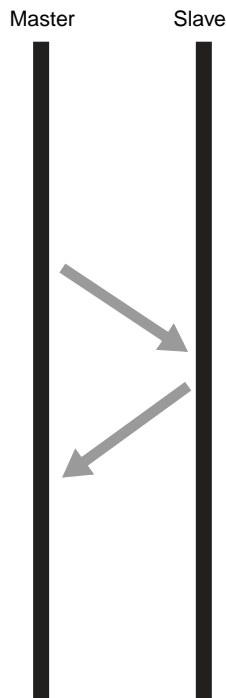

#### Reply Message Composition (bytes)

Station No.	
Function Code	
No. of Bytes to Read (No. of Words to Read x 2)	
First Word Data Contents	Upper
	Lower
Next Word Data Contents	Upper
	Lower
⋮	
Last Word Data Contents	Upper
	Lower
CRC Data	Upper
	Lower

#### ■ Meaning of Read Word Data

MSB	LSB
First Word Data upper byte	
First Word Data lower byte	
Next Word Data upper byte	
Next Word Data lower byte	
⋮	
Last Word Data upper byte	
Last Word Data lower byte	

### Example of Transmitting a Message (For Engineering Unit)

The message is composed as follows when reading the PV input lower limit and PV input upper limit from station number 2.

- PV Lower Limit Relative Address: 07E1H

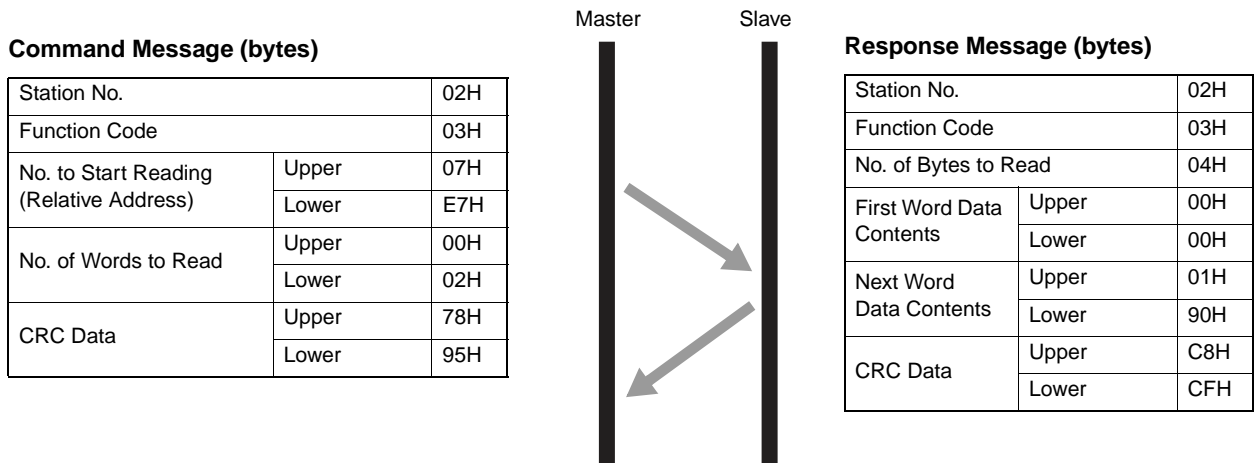

#### ■ Meaning of Read Data

PV Input Lower Limit 00 00H = 0

PV Input Upper Limit 01 90H = 400

If Decimal Point Position = 0, then the PV input upper limit and lower limit are as follows.

PV Lower Limit = 0°C

PV Upper Limit = 400°C

**Refer to** For more about the internal calculation value, engineering unit, and decimal point see "Chapter 7, Address Map and Data Format" (p. 39).

The unit reads word data continuously for the specified number of words from the first number to start reading from. The slave forwards the read word data from the upper number of bytes to the lower number.

Function Code	04H	
Max. No. of Words to Read in One Message	60 words	
Relative Address	0000H to 07CFH	07D0H to 08BFH
Resistor Number	30001 to 32000	32001 to 32240
Contents	Internal Calculation Value	Engineering Unit

### Message Composition

#### Command Message Composition (bytes)

Station No.	
Function Code	
No. to Start Reading (Relative Address)	Upper
	Lower
No. of Words to Read (1 to 60 words)	Upper
	Lower
CRC Data	Upper
	Lower

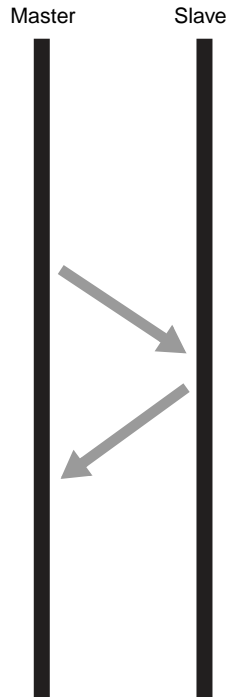

#### Reply Message Composition (bytes)

Station No.	
Function Code	
No. of Bytes to Read (No. of Words to Read x 2)	
First Word Data Contents	Upper
	Lower
Next Word Data Contents	Upper
	Lower
⋮	
Last Word Data Contents	Upper
	Lower
CRC Data	Upper
	Lower



#### ■ Meaning of Read Word Data

MSB LSB

First Word Data upper byte
First Word Data lower byte
Next Word Data upper byte
Next Word Data lower byte
⋮
Last Word Data upper byte
Last Word Data lower byte

### Example of Transmitting a Message (Internal Calculation Data)

The message is composed as follows when reading the PV input value from station number 1.

- PV value relative address: 0000H Number of data: 01H

#### Command Message (bytes)

Station No.	01H	
Function Code	04H	
No. to Start Reading (Relative Address)	Upper	00H
	Lower	00H
No. of Bits to Read	Upper	00H
	Lower	01H
CRC Data	Upper	31H
	Lower	CAH

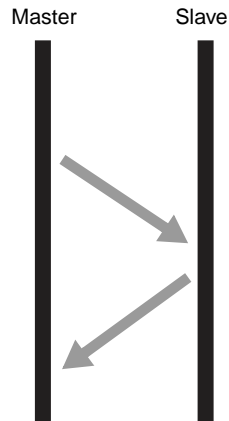

#### Response Message (bytes)

Station No.	01H	
Function Code	04H	
No. of Bytes to Read	02H	
First Word Data Contents	Upper	03H
	Lower	46H
CRC Data	Upper	38H
	Lower	32H

#### ■ Meaning of Read Data

Word Data Contents 03 46H = 838 (8.38% FS)

When the input range is 0 to 400°C

PV = 33.5°C (= 8.38% FS x 400 (input range width))

Refer to  For more about the internal calculation value, engineering unit, and decimal point see "Chapter 7, Address Map and Data Format" (p. 39).

### Example of Transmitting a Message (For Engineering Unit)

The message is composed as follows when reading the PV value from station number 1.

- PV value relative address: 07D0H Number of data: 01H

#### Command Message (bytes)

Station No.	01H	
Function Code	04H	
No. to Start Reading (Relative Address)	Upper	07H
	Lower	D0H
No. of Words to Read	Upper	00H
	Lower	01H
CRC Data	Upper	47H
	Lower	31H

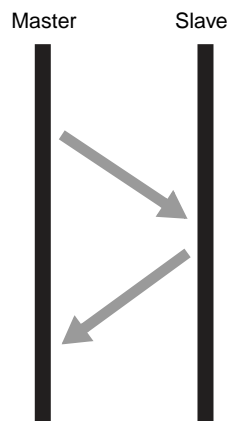

#### Response Message (bytes)

Station No.	01H	
Function Code	04H	
No. of Bytes to Read	02H	
First Word Data Contents	Upper	01H
	Lower	4FH
CRC Data	Upper	F9H
	Lower	54H

#### ■ Meaning of Read Data

Word Data Contents 01 4FH = 335

When the decimal point position = 1

PV = 33.5°C

Refer to  For more about the internal calculation value, engineering unit, and decimal point see "Chapter 7, Address Map and Data Format" (p. 39).

# Writing Data

This writes the specified data to the specified number for word data. The master sends the data to be written from the upper number of bytes to the lower number.

Function Code	06H	
Max. No. of Bits to Read in One Message	1 words	
Relative Address	0001H to 07CFH	07D0H to 13A7H
Resistor Number	40004 to 42000	42001 to 45032
Contents	Internal Calculation Value	Engineering Unit

## Message Composition

### Command Message Composition (bytes)

Station No.	
Function Code	
Specified Write Number (Relative Address)	Upper
	Lower
Word Data to Write	Upper
	Lower
CRC Data	Upper
	Lower

Master                  Slave

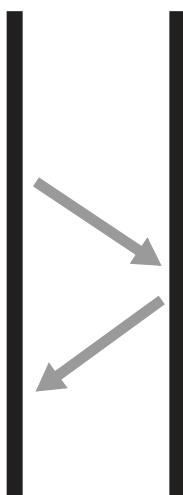

### Response Message Composition (bytes)

Station No.	
Function Code	
Specified Write Number (Relative Address)	Upper
	Lower
Word Data to Write	Upper
	Lower
CRC Data	Upper
	Lower



## Example of Transmitting a Message

This example explains how to set PID parameter "P" to 100.0 (1000D = 03E8H) on station number 1.

Parameter "P" relative address: 0005H (internal calculation value table)  
07D5H (initial value table)

### Command Message (bytes)

Station No.	01H	
Function Code	06H	
Specified Write Number (Relative Address)	Upper	00H
	Lower	05H
Word Data to Write	Upper	03H
	Lower	E8H
CRC Data	Upper	99H
	Lower	75H

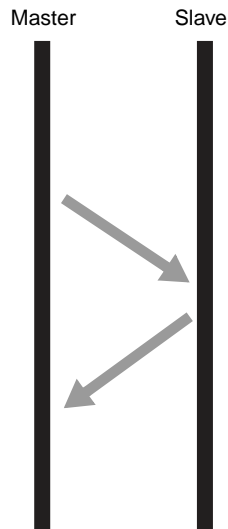

### Response Message (bytes)

Station No.	01H	
Function Code	06H	
Specified Write Number (Relative Address)	Upper	00H
	Lower	05H
Write Specification State	Upper	03H
	Lower	E8H
CRC Data	Upper	99H
	Lower	75H

### Point

For more about the internal calculation value, engineering unit, and decimal point see "Sent Data Format" (p. 40).

This writes continuous word information for a number of written words from the first number for writing. The master sends the data to be written from the upper number of bytes to the lower number.

Function Code	10H	
Max. No. of Bits to Read in One Message	60 words	
Relative Address	0000H to 07CFH	07D0H to 13A7H
Resistor Number	40001 to 42000	42001 to 45032
Contents	Internal Calculation Value	Engineering Unit

### Message Composition

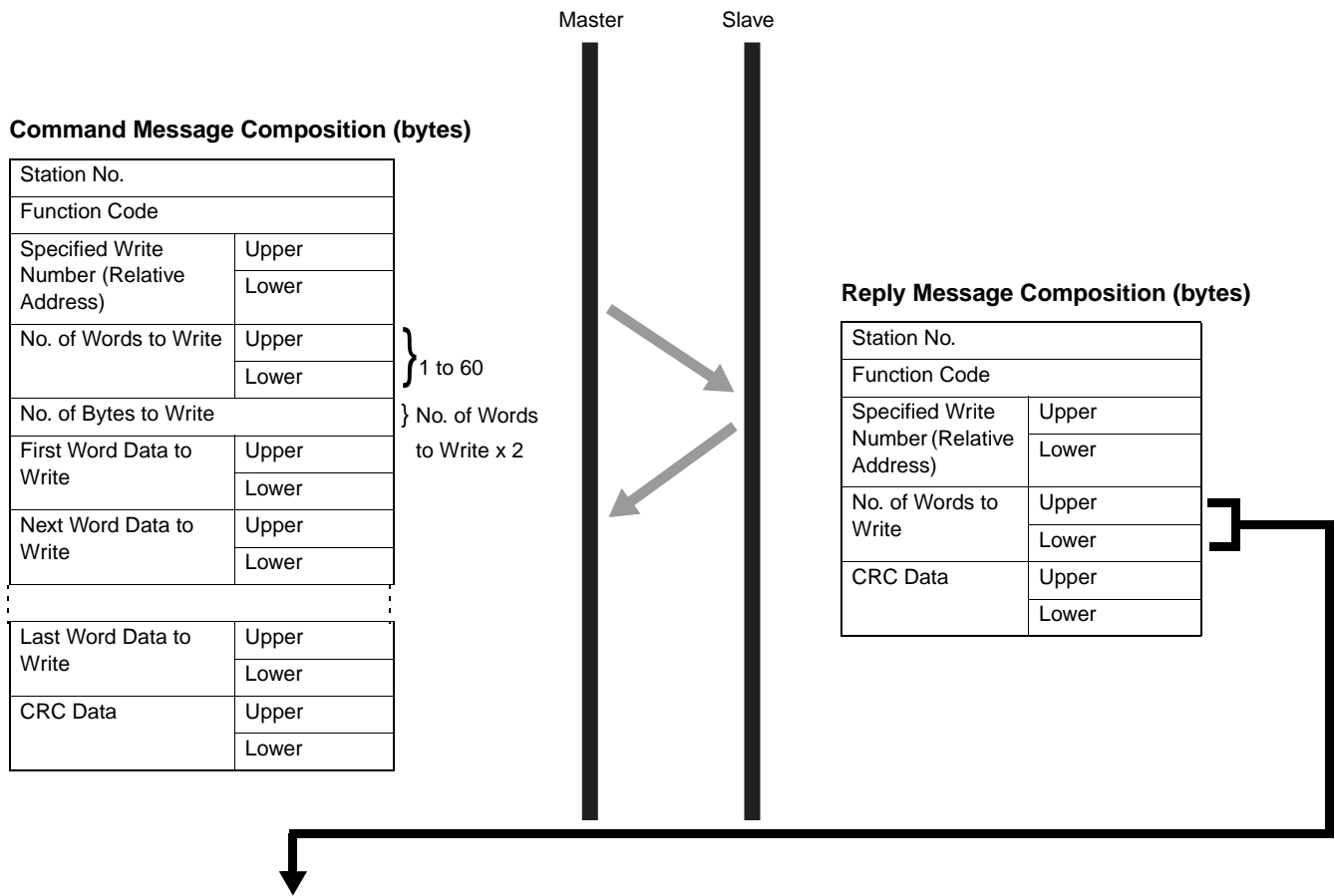

#### ■ Meaning of Read Word Data

MSB	LSB
First Word Data upper byte	
First Word Data lower byte	
Next Word Data upper byte	
Next Word Data lower byte	
...	
Last Word Data upper byte	
Last Word Data lower byte	

### Example of Transmitting a Message (Internal Calculation Data)

The message is composed as follows when writing the following PID parameters to station number 1.

P = 100.0 (= 1000D = 03E8H)

I = 10 (= 100D = 0064)

D = 5.0 (= 50D = 0032H)

- Parameter "P" relative address: 0005H, Data number: 03H

#### Command Message (bytes)

Station No.		01H
Function Code		10H
Specified Write Number (Relative Address)	Upper	00H
	Lower	05H
No. of Words to Write	Upper	00H
	Lower	03H
No. of Bytes to Write		06H
First Word Data to Write	Upper	03H
	Lower	E8H
Next Word Data to Write	Upper	00H
	Lower	64H
Last Word Data to Write	Upper	00H
	Lower	32H
CRC Data	Upper	56H
	Lower	BEH

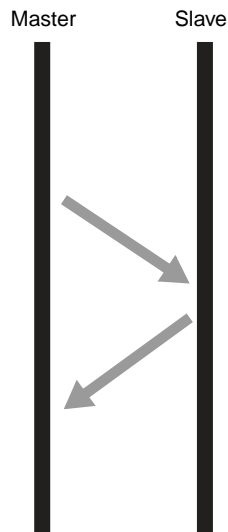

#### Response Message (bytes)

Station No.		01H
Function Code		10H
Specified Write Number (Relative Address)	Upper	00H
	Lower	05H
Write Specification State	Upper	00H
	Lower	03H
CRC Data	Upper	90H
	Lower	09H

#### Point

The decimal point cannot be included in the sent data, so data such as "100.0" above is sent as "1000".

Refer to



For each type of send data format, see "Chapter 7, Address Map and Data Format" (p. 39).

# Chapter 7

## Address Map and Data Format

Data Format – 38



Internal Calculation Value Data Address Map – 40

# Data Format

## Sent Data Format

The MODBUS protocol used by this equipment employs RTU (Remote Terminal Unit) mode. The data is sent as "numerical value", not as ASCII code.

## Internal Calculation Value and Engineering Unit

In this unit, parameter data and data dependent on an input range can handle the following two types of data.

Internal Calculation Value: Values listed as percentages of the input range (0.00 to 100.00, without decimal point)

Engineering Unit: Values subjected to scaling to actual values depending on the input range

"Engineering Unit" data is handled as the address (resister number) of 2000 added to the address (resister number) for "Internal Calculation Value".

(Ex.) The value is calculated as follows when the full scale is 400°C and the PV value is "150".

Class	Resistor Number	Data (HEX)		Data
Internal Calculation Value	30001	0EA6 (H)	→	3750 (37.5%)
Engineering unit	32001	0096 (H)		150

The PV value is received as follows.

$$37.50 (\%) \times 400 (\text{full scale } ^\circ\text{C}) = 150 \text{ } ^\circ\text{C}$$

Data not dependent on an input range the same data in both addresses.

 For more about data dependent on an input range, see "Chapter 7 Address Map and Data Format" (page 39).

**Caution** Pay attention to the position of the decimal point when changing the input range by writing with communication. When changing the position of the decimal point by writing with communication, change the lower limit and upper limit of the input range at the same time.

(Ex.) When changing the input range from 0 to 400 to 0.0 to 400.0

### ■ Operating the keys on the front of the equipment

Change the position of the decimal point ("Pvd") in the setup menu ("SET Ch 6").

"Pvd" = 0 → 1 (or 2)

### ■ Changing by communication

Set the decimal position parameter ("Pvd"), as well as the corresponding values for PF input lower limit ("Pvb") and PV input upper limit ("PvF").

"Pvd" = 0 → 1

"Pvb" = 0 → 0

"PvF" = 400 → 4000

## Managing the Decimal Point

Some of the internally stored data may contain may digits lower than the decimal point on the front display. Also, the decimal point is not added to sent data.

Carry out processes for the decimal point position (erasing the decimal point when sending data and adding the decimal point when receiving data).

Attention must be paid to the position of the decimal point for data where the parameters are dependent on a range in "Chapter 7 Address Map and Data Format". Refer to Address Map.

---

## Data during Input Error

For situations such as overrange, underrange, and input breaks where "UUUU" or "LLLL" display on the front, read PV value becomes 105% or -5% of the input range.

Input errors can be detected via communication using "resistor number 30008 (or 31008): Input/Unit Error Status".

## Written Data

When writing data to each parameter, set that written data within the range for the data. PXF can accept written data outside of the range, but do so with care as correct operations are not guaranteed.

## Addresses Not Written

Do not write to addresses that are not public. Doing so may cause damage.

# Internal Calculation Value Data Address Map

Handles data dependent on an input range as an internal value before scaling (0.00 to 100.00%).

See "Operation Manual" for more details about individual parameter functions and settings ranges.

**Word Data (read/write): function code [03 (H), 06 (H), 10 (H)]**

## Operation control parameter

No.	Display	Value		Function	Relative address	Register No.		Read data	Written data range	Factory-set value	Dependent on range	Remarks
		Name				Internal	Engineering unit					
1	MAN	Switchover between auto and manual mode		Switches between auto and manual modes	0084H	40133	42133	0: oFF (auto) 1: on (manual)		oFF		
2	STby	Switchover between RUN and standby		Switches the operation mode between RUN and standby	0003H	40004	42004	0: oFF (RUN) 1: on (standby)		oFF		
3	REM	Local/remote switchover		Switches SV between local/remote.	0074 H	40117	42117	LoCL (local)/ rEM (remote)		LoCL		
4	PrG	Ramp soak control command		Changes ramp soak run states	0051H	40082	42082	0: oFF (stop) 1: rUn (during run) 2: hLd (during hold) 3: ENd (end) 4: GS (during guarantee soak)	0: oFF (stop) 1: rUn (run) 2: hLd (hold)	oFF		
5	AT	Auto-tuning run command		Runs auto-tuning.	0004H	40005	42005	0: oFF (stop/finish) 1: on (normal type) 2: Lo (low PV type)		oFF		
6	LACH	Alarm output latch release command		Cancels the alarm output latch state	00A0H	40161	42161	0: oFF 1: rST (latch reset)		oFF		
7	Svn	SV selection		Chooses the SV No. to be used for control.	00DCH	40221	42221	0: LoCL (local SV) 1: Sv1 (SV = SV1) 2: Sv2 (SV = SV2) 3: Sv3 (SV = SV3) 4: Sv4 (SV = SV4) 5: Sv5 (SV = SV5) 6: Sv6 (SV = SV6) 7: Sv7 (SV = SV7) 8: di (according to DI)		LoCL		When changing the SV with the front key, do not change the "Svn" parameter via communication. Otherwise, the changed SV may not be stored correctly.
8	PLn1	PID selection		Chooses the PID No. to be used for control.	00DDH	40222	42222	0: LoCL (local PID group) 1: Pid1 (PID group No.1) 2: Pid2 (PID group No.2) 3: Pid3 (PID group No.3) 4: Pid4 (PID group No.4) 5: Pid5 (PID group No.5) 6: Pid6 (PID group No.6) 7: Pid7 (PID group No.7) 8: di (according to DI)		LoCL		
9	AL1	ALM1 set value		Sets the alarm value for ALM1.	00A2H	40163	42163	Absolute value alarm: 0 to 100% FS Deviation alarm: -100 to 100% FS	2.50%FS	○		
10	AL1L											
11	AL1h											
12	AL2	ALM2 set value		Sets the alarm value for ALM2.	00A9H	40170	42170	Absolute value alarm: 0 to 100% FS Deviation alarm: -100 to 100% FS	2.50%FS	○		
13	AL2L											
14	AL2h											
15	AL3	ALM3 set value		Sets the alarm value for ALM3.	00B0H	40177	42177	Absolute value alarm: 0 to 100% FS Deviation alarm: -100 to 100% FS	2.50%FS	○		
16	AL3L											
17	AL3h											
18	AL4	ALM4 set value		Sets the alarm value for ALM4.	00B7H	40184	42184	Absolute value alarm: 0 to 100% FS Deviation alarm: -100 to 100% FS	2.50%FS	○		
19	AL4L											
20	AL4h											
21	AL5	ALM5 set value		Sets the alarm value for ALM5.	00BEH	40191	42191	Absolute value alarm: 0 to 100% FS Deviation alarm: -100 to 100% FS	2.50%FS	○		
22	AL5L											
23	AL5h											
27	WCMd	Electric power calculation command		Switches the electric power calculation status	031FH	40800	42800	0: oFF (off) 1: rUn (run) 2: hLd (hold)		oFF		
28	LoC	Key lock		Sets the key lock to prevent wrong operation	0027H	40040	42040	0: oFF (no lock) 1: ALL (all lock) 2: PArA (all but SV locked)		oFF		

## Ch1 PID (control parameters)

No.	Display	Value		Function	Relative address	Register No.		Read data	Written data range	Factory-set value	Dependent on range	Remarks
		Name				Internal	Engineering unit					
50	P	Proportional band (%)		Sets the proportional band of the PID parameter.	0005 H	40006	42006	0 to 9999 (0.1 to 999.9%)		5.0%		
51	i	Integration time		Sets the integration time of the PID parameter. Setting "0" will turn off integration.	0006 H	40007	42007	0 to 32000 (0 to 3200 sec)		240 sec		
52	d	Differential time		Sets the differential band of the PID parameter. Setting "0" will turn off differentiation.	0007 H	40008	42008	0 to 9999 (0.0 to -999.9 sec)		60.0 sec		
53	hyS	ON/OFF control hysteresis		Sets the hysteresis width for the ON/OFF control.	0008 H	40009	42009	0 to 50%FS		0.25%FS	○	
54	CoL	Cooling proportional band coefficient		Sets the proportional band coefficient for cooling. Setting "0.0" will turn the cooling into an ON/OFF control.	0009 H	40010	42010	0 to 1000 (0.0 to 100.0)		1.0		
55	db	Dead band (%)		Shifts the cooling proportional band from the set value	000AH	40011	42011	-5000 to 5000 (-50.0 to 50.0%)		0.0%		
56	bAL	Output convergence value (%)		Offset value which is added to the MV output value	000CH	40013	42013	-1000 to 1000 (-100.0 to 100.0%)		Single control: 0.0% Dual control: 50.0%		
57	Ar	Anti-reset windup		Sets the range of integration control	000BH	40012	42012	0 to 100% FS		100% FS	○	
58	rEv	Normal/reverse operations		Selects single control or dual control. Sets the control action (normal or reverse).	0057 H	40088	42088	0: rv-- (heat (reverse)/cool (none)) 1: no-- (heat (normal)/cool (none)) 2: rvno (heat (reverse)/cool (normal)) 3: norv (heat (normal)/cool (reverse)) 4: rrvv (heat (reverse)/cool (reverse)) 5: nono (heat (normal)/cool (normal))		Single control: rv-- Dual control: rvno		[RESET]
59	SvL	SV limit (lower)		Sets the lower limit of SV	001EH	40031	42031	0 to 100%FS		0.00%FS	○	Note 1)
60	Svh	SV limit (upper)		Sets the upper limit of SV	001FH	40032	42032	0 to 100%FS		100.00%FS	○	Note 1)
61	TC1	OUT1 proportion cycle		Sets the proportion cycle of the control output (OUT1) (contacts, SSR drive)	0058 H	40089	42089	1 to 150 (1 to 150 sec)		30 (relay) 2 (SSR) 1 (current)		
62	TC2	OUT2 proportion cycle		Sets the proportion cycle of the control output (OUT2) (contacts, SSR drive)	0059 H	40090	42090	1 to 150 (1 to 150 sec)		30 (relay) 2 (SSR) 1 (current)		
63	PLC1	OUT1 lower limit		Sets the lower limit of the control output (OUT1)	0018 H	40025	42025	-500 to 10500 (-5.0 to 105.0%)		-5.0%		
64	PhC1	OUT1 upper limit		Sets the upper limit of the control output (OUT1)	0019 H	40026	42026	-500 to 10500 (-5.0 to 105.0%)		105.0%		
65	PLC2	OUT2 lower limit		Sets the lower limit of the control output (OUT2)	001AH	40027	42027	-500 to 10500 (-5.0 to 105.0%)		-5.0%		
66	PhC2	OUT2 upper limit		Sets the upper limit of the control output (OUT2)	001BH	40028	42028	-500 to 10500 (-5.0 to 105.0%)		105.0%		
67	PCUT	Type of output limiter		Type of output limiter	0017 H	40024	42024	0 to 15		0		
73	ALPA	Alpha		Sets 2-degrees-of-freedom coefficient $\alpha$	01B3H	40436	42436	-1999 to 3000 (-199.9 to 300.0%)		40.0%		
74	bEtA	Beta		Sets 2-degrees-of-freedom coefficient $\beta$	01B4H	40437	42437	0 to 9999 (0.0 to 999.9%)		100.0%		

Note 1: "SvL" and "Svh" must be set so that SvL < Svh. When you change the values for "SvL" and "Svh", check SV 1 ("Sv1 Ch2") through SV 7 ("Sv7 Ch2").



## Ch2 PLT (PID palette parameters)

No.	Display	Name	Function	Relative address	Register No.		Read data	Written data range	Factory-set value	Dependent on range	Remarks
					Internal	Engineering unit					
100	Sv1	SV1	Sets the SV (set value)	00F0 H	40241	42241	SV limit (lower)(SVL) to SV limit (upper)(SVH) %FS		0%FS	○	Note 1)
101	P1	Proportional band 1 (%)	Sets the proportional band.	00F1 H	40242	42242	0 to 9999 (0.1 to 999.9%)		5.0%		
102	i1	Integration time 1	Sets the integration time.	00F2 H	40243	42243	0 to 32000 (0 to 3200 sec)		240 sec		
103	d1	Differential time 1	Sets the differential time.	00F3 H	40244	42244	0 to 9999 (0.0 to -999.9 sec)		60.0 sec		
104	hyS1	ON/OFF control hysteresis 1	Sets the hysteresis when using the ON/OFF control.	00F4 H	40245	42245	0 to 50%FS		0.25%FS	○	
105	CoL1	Cooling proportional band 1 (%)	Sets the cooling proportional band.	00F5 H	40246	42246	0 to 1000 (0.0 to 100.0)		1.0		
106	db1	Dead band 1 (%)	Sets the dead band	00F6 H	40247	42247	-5000 to 5000 (-50.0 to 50.0%)		0.0%		
107	bAL1	Output convergence value 1 (%)	Offset value which is added to the control output	00F7 H	40248	42248	-1000 to 1000 (-100.0 to 100.0%)		Single control: 0.0% Dual control: 50.0%		
108	Ar1	Anti-reset windup 1		00F8 H	40249	42249	0 to 100%FS		100%FS	○	
109	rEv1	Normal/reverse 1	Sets the anti-reset windup Selects single control or dual control. Sets the control action (normal or reverse).	00F9 H	40250	42250	0: rv-- (heat (reverse)/cool (none)) 1: no-- (heat (normal)/cool (none)) 2: rvno (heat (reverse)/cool (normal)) 3: norv (heat (normal)/cool (reverse)) 4: rrvv (heat (reverse)/cool (reverse)) 5: nono (heat (normal)/cool (normal))		Single control: rv-- Dual control: rvno		Note 2) [RESET]
110	Sv2	SV 2		00FA H	40251	42251	SV limit (lower)(SVL) to SV limit (upper)(SVH) %FS		0.00%FS	○	Note 1)
111	P2	Proportional band 2 (%)		00FB H	40252	42252	0 to 9999 (0.1 to 999.9%)		5.0%		
112	i2	Integration time 2		00FC H	40253	42253	0 to 32000 (0 to 3200 sec)		240 sec		
113	d2	Differential time 2		00FD H	40254	42254	0 to 9999 (0.0 to -999.9 sec)		60.0 sec		
114	hyS2	ON/OFF control hysteresis 2		00FE H	40255	42255	0 to 50%FS		0.25%FS	○	
115	CoL2	Cooling proportional band 2 (%)		00FF H	40256	42256	0 to 1000 (0.0 to 100.0)		1.0		
116	db2	Dead band 2 (%)		0100 H	40257	42257	-5000 to 5000 (-50.0 to 50.0%)		0.0%		
117	bAL2	Output convergence value 2 (%)		0101 H	40258	42258	-1000 to 1000 (-100.0 to 100.0%)		Single control: 0.0% Dual control: 50.0%		
118	Ar2	Anti-reset windup 2		0102 H	40259	42259	0 to 100%FS		100.00%FS	○	
119	rEv2	Normal/reverse 2		0103 H	40260	42260	0: rv-- (heat (reverse)/cool (none)) 1: no-- (heat (normal)/cool (none)) 2: rvno (heat (reverse)/cool (normal)) 3: norv (heat (normal)/cool (reverse)) 4: rrvv (heat (reverse)/cool (reverse)) 5: nono (heat (normal)/cool (normal))		Single control: rv-- Dual control: rvno		Note 2) [RESET]
120	Sv3	SV 3		0104 H	40261	42261	SV limit (lower)(SVL) to SV limit (upper)(SVH) %FS		0.00%FS	○	Note 1)
121	P3	Proportional band 3 (%)		0105 H	40262	42262	0 to 9999 (0.1 to 999.9%)		5.0%		
122	i3	Integration time 3		0106 H	40263	42263	0 to 32000 (0 to 3200 sec)		240 sec		
123	d3	Differential time 3		0107 H	40264	42264	0 to 9999 (0.0 to -999.9 sec)		60.0 sec		
124	hyS3	ON/OFF control hysteresis 3		0108 H	40265	42265	0 to 50%FS		0.25%FS	○	
125	CoL3	Cooling proportional band 3 (%)		0109 H	40266	42266	0 to 1000 (0.0 to 100.0)		1.0		
126	db3	Dead band 3 (%)		010A H	40267	42267	-5000 to 5000 (-50.0 to 50.0%)		0.0%		
127	bAL3	Output convergence value 3 (%)		010B H	40268	42268	-1000 to 1000 (-100.0 to 100.0%)		Single control: 0.0% Dual control: 50.0%		
128	Ar3	Anti-reset windup 3		010C H	40269	42269	0 to 100%FS		100.00%FS	○	
129	rEv3	Normal/reverse 3		010D H	40270	42270	0: rv-- (heat (reverse)/cool (none)) 1: no-- (heat (normal)/cool (none)) 2: rvno (heat (reverse)/cool (normal)) 3: norv (heat (normal)/cool (reverse)) 4: rrvv (heat (reverse)/cool (reverse)) 5: nono (heat (normal)/cool (normal))		Single control: rv-- Dual control: rvno		Note 2) [RESET]
130	Sv4	SV 4		010E H	40271	42271	SV limit (lower)(SVL) to SV limit (upper)(SVH) %FS		0.00%FS	○	Note 1)
131	P4	Proportional band 4 (%)		010F H	40272	42272	0 to 9999 (0.1 to 999.9%)		5.0%		
132	i4	Integration time 4		0110 H	40273	42273	0 to 32000 (0 to 3200 sec)		240 sec		
133	d4	Differential time 4		0111 H	40274	42274	0 to 9999 (0.0 to -999.9 sec)		60.0 sec		
134	hyS4	ON/OFF control hysteresis 4		0112 H	40275	42275	0 to 50%FS		0.25%FS	○	
135	CoL4	Cooling proportional band 4 (%)		0113 H	40276	42276	0 to 1000 (0.0 to 100.0)		1.0		
136	db4	Dead band 4 (%)		0114 H	40277	42277	-5000 to 5000 (-50.0 to 50.0%)		0.0%		
137	bAL4	Output convergence value 4 (%)		0115 H	40278	42278	-1000 to 1000 (-100.0 to 100.0%)		Single control: 0.0% Dual control: 50.0%		
138	Ar4	Anti-reset windup 4		0116 H	40279	42279	0 to 100%FS		100.00%FS	○	
139	rEv4	Normal/reverse 4		0117 H	40280	42280	0: rv-- (heat (reverse)/cool (none)) 1: no-- (heat (normal)/cool (none)) 2: rvno (heat (reverse)/cool (normal)) 3: norv (heat (normal)/cool (reverse)) 4: rrvv (heat (reverse)/cool (reverse)) 5: nono (heat (normal)/cool (normal))		Single control: rv-- Dual control: rvno		Note 2) [RESET]
140	Sv5	SV 5		0118 H	40281	42281	SV limit (lower)(SVL) to SV limit (upper)(SVH) %FS		0.00%FS	○	Note 1)
141	P5	Proportional band 5 (%)		0119 H	40282	42282	0 to 9999 (0.1 to 999.9%)		5.0%		
142	i5	Integration time 5		011A H	40283	42283	0 to 32000 (0 to 3200 sec)		240 sec		
143	d5	Differential time 5		011B H	40284	42284	0 to 9999 (0.0 to -999.9 sec)		60.0 sec		
144	hyS5	ON/OFF control hysteresis 5		011C H	40285	42285	0 to 50%FS		0.25%FS	○	

No.	Display	Value Name	Function	Relative address	Register No.		Read data	Written data range	Factory-set value	Dependent on range	Remarks
					Internal	Engineering unit					
145	CoL5	Cooling proportional band 5 (%)		011D H	40286	42286	0 to 1000 (0.0 to 100.0)		1.0		
146	db5	Dead band 5 (%)		011E H	40287	42287	-5000 to 5000 (-50.0 to 50.0%)		0.0%		
147	bAL5	Output convergence value 5 (%)		011F H	40288	42288	-1000 to 1000 (-100.0 to 100.0%)		Single control: 0.0% Dual control: 50.0%		
148	Ar5	Anti-reset windup 5		0120 H	40289	42289	0 to 100%FS		100.00%FS	○	
149	rEv5	Normal/reverse 5		0121 H	40290	42290	0: rv-- (heat (reverse)/cool (none)) 1: no-- (heat (normal)/cool (none)) 2: rvno (heat (reverse)/cool (normal)) 3: norv (heat (normal)/cool (reverse)) 4: rrvv (heat (reverse)/cool (reverse)) 5: nono (heat (normal)/cool (normal))		Single control: rv-- Dual control: rvno		Note 2 [RESET]
150	Sv6	SV 6		0122 H	40291	42291	SV limit (lower)(SVL) to SV limit (upper)(SVH) %FS		0.00%FS	○	Note 1)
151	P6	Proportional band 6 (%)		0123 H	40292	42292	0 to 9999 (0.1 to 999.9%)		5.0%		
152	i6	Integration time 6		0124 H	40293	42293	0 to 32000 (0 to 3200 sec)		240 sec		
153	d6	Differential time 6		0125 H	40294	42294	0 to 9999 (0.0 to -999.9 sec)		60.0 sec		
154	hyS6	ON/OFF control hysteresis 6		0126 H	40295	42295	0 to 50%FS		0.25%FS	○	
155	CoL6	Cooling proportional band 6 (%)		0127 H	40296	42296	0 to 1000 (0.0 to 100.0)		1.0		
156	db6	Dead band 6 (%)		0128 H	40297	42297	-5000 to 5000 (-50.0 to 50.0%)		0.0%		
157	bAL6	Output convergence value 6 (%)		0129 H	40298	42298	-1000 to 1000 (-100.0 to 100.0%)		Single control: 0.0% Dual control: 50.0%		
158	Ar6	Anti-reset windup 6		012A H	40299	42299	0 to 100%FS		100.00%FS	○	
159	rEv6	Normal/reverse 6		012B H	40300	42300	0: rv-- (heat (reverse)/cool (none)) 1: no-- (heat (normal)/cool (none)) 2: rvno (heat (reverse)/cool (normal)) 3: norv (heat (normal)/cool (reverse)) 4: rrvv (heat (reverse)/cool (reverse)) 5: nono (heat (normal)/cool (normal))		Single control: rv-- Dual control: rvno		Note 2 [RESET]
160	Sv7	SV 7	Sets the SV (set value)	012C H	40301	42301	SV limit (lower)(SVL) to SV limit (upper)(SVH) %FS		0.00%FS	○	Note 1)
161	P7	Proportional band 7 (%)	Sets the proportional band.	012D H	40302	42302	0 to 9999 (0.1 to 999.9%)		5.0%		
162	i7	Integration time 7	Sets the integration time.	012E H	40303	42303	0 to 32000 (0 to 3200 sec)		240 sec		
163	d7	Differential time 7	Sets the differential time.	012F H	40304	42304	0 to 9999 (0.0 to -999.9 sec)		60.0 sec		
164	hyS7	ON/OFF control hysteresis 7	Sets the hysteresis when using the ON/OFF control.	0130 H	40305	42305	0 to 50%FS		0.25%FS	○	
165	CoL7	Cooling proportional band 7 (%)		0131 H	40306	42306	0 to 1000 (0.0 to 100.0)		1.0		
166	db7	Dead band 7 (%)	Sets the dead band	0132 H	40307	42307	-5000 to 5000 (-50.0 to 50.0%)		0.0%		
167	bAL7	Output convergence value7 (%)	Offset value which is added to the control output	0133 H	40308	42308	-1000 to 1000 (-100.0 to 100.0%)		Single control: 0.0% Dual control: 50.0%		
168	Ar7	Anti-reset windup 7	Sets the anti-reset windup	0134	40309	42309	0 to 100%FS		100.00%FS	○	
169	rEv7	Normal/reverse 7	Selects single control or dual control. Sets the control action (normal or reverse).	0135	40310	42310	0: rv-- (heat (reverse)/cool (none)) 1: no-- (heat (normal)/cool (none)) 2: rvno (heat (reverse)/cool (normal)) 3: norv (heat (normal)/cool (reverse)) 4: rrvv (heat (reverse)/cool (reverse)) 5: nono (heat (normal)/cool (normal))		Single control: rv-- Dual control: rvno		Note 2 [RESET]
170	rEF1	PID switching point 1	Sets the PID switching point for palette 1.	0136 H	40311	42311	0 to 100%FS		0%FS	○	
171	rEF2	PID switching point 2	Sets the PID switching point for palette 2.	0137 H	40312	42312	0 to 100%FS		0%FS	○	
172	rEF3	PID switching point 3	Sets the PID switching point for palette 3.	0138 H	40313	42313	0 to 100%FS		0%FS	○	
173	rEF4	PID switching point 4	Sets the PID switching point for palette 4.	0139 H	40314	42314	0 to 100%FS		0%FS	○	
174	rEF5	PID switching point 5	Sets the PID switching point for palette 5.	013A H	40315	42315	0 to 100%FS		0%FS	○	
175	rEF6	PID switching point 6	Sets the PID switching point for palette 6.	013B H	40316	42316	0 to 100%FS		0%FS	○	
176	rEF6	PID switching point 7	Sets the PID switching point for palette 7.	01A0 H	40417	42417	0 to 100%FS		0%FS	○	
177	SvMX	Max SV selection number	Sets the maximum SV number that the USER key can select.	00DF H	40224	42224	0: LoCL (local SV) 1: Sv1 (SV = SV1) 2: Sv2 (SV = SV2) 3: Sv3 (SV = SV3) 4: Sv4 (SV = SV4) 5: Sv5 (SV = SV5) 6: Sv6 (SV = SV6) 7: Sv7 (SV = SV7) 8: di (according to DI)		Sv7		
178	PL1M	Max PID selection number	Sets the maximum PID number that the USER key can select.	00E0 H	40225	42225	0: LoCL (PID group local) 1: Pid1 (PID group No.1) 2: Pid2 (PID group No.2) 3: Pid3 (PID group No.3) 4: Pid4 (PID group No.4) 5: Pid5 (PID group No.5) 6: Pid6 (PID group No.6) 7: Pid7 (PID group No.7) 8: di (according to DI)		Pid7		

Note 1: "SvL" and "Svh" must be set so that SvL < Svh. When you change the values for "SvL" and "Svh", check SV 1 ("Sv1 Ch2") through SV 7 ("Sv7 Ch2").

Note 2: Set the same value as the one for the Normal/Reverse setting ("rEv Ch1").

### Ch 3 PRG (ramp soak parameters)

No.	Display	Value Name	Function	Relative address	Register No.		Read data	Written data range	Factory-set value	Dependent on range	Remarks
					Internal	Engineering unit					
200	PTn	Ramp soak operation pattern (Step No.)	Sets which steps to use in the ramp soak operation pattern	0230 H	40561	42561	0 (uses steps 1 to 8) 1 (uses steps 9 to 16) 2 (uses steps 17 to 24) 3 (uses steps 25 to 32) 4 (uses steps 33 to 40) 5 (uses steps 41 to 48) 6 (uses steps 49 to 56) 7 (uses steps 57 to 64) 8 (uses steps 0 to 16) 9 (uses steps 17 to 32) 10 (uses steps 33 to 48) 11 (uses steps 49 to 64) 12 (uses steps 0 to 32) 13 (uses steps 33 to 64) 14 (uses steps 0 to 64) 15 (according to DI)		0		Note 1)
201	TMU	Ramp soak time units	Sets the units of the ramp soak time	0231 H	40562	42562	0: hh.MM (hour:min) 1: MM.SS (min:sec)		hh.MM		
202	Sv-1	Ramp soak 1 seg/SV 1	Sets the SV	0244 H	40581	42581	0 to 100%FS		0%FS	○	
203	TM1r	Ramp soak 1 seg ramp time	Sets the ramp time.	0245 H	40582	42582	0-5999 (00:00 to 99:59) (hour:min/min:sec)		00:00		
204	TM1S	Ramp soak 1 seg soak time	Sets the soak time.	0246 H	40583	42583	0-5999 (00:00 to 99:59) (hour:min/min:sec)		00:00		
205	Sv-2	Ramp soak 2 seg/SV 2	Sets the SV	0247 H	40584	42584	0 to 100%FS		0%FS	○	
206	TM2r	Ramp soak 2 seg ramp time	Sets the ramp time.	0248 H	40585	42585	0-5999 (00:00 to 99:59) (hour:min/min:sec)		00:00		
207	TM2S	Ramp soak 2 seg soak time	Sets the soak time.	0249 H	40586	42586	0-5999 (00:00 to 99:59) (hour:min/min:sec)		00:00		
208	Sv-3	Ramp soak 3 seg/SV 3	Sets the SV	024AH	40587	42587	0 to 100%FS		0%FS	○	
209	TM3r	Ramp soak 3 seg ramp time	Sets the ramp time.	024BH	40588	42588	0-5999 (00:00 to 99:59) (hour:min/min:sec)		00:00		
210	TM3S	Ramp soak 3 seg soak time	Sets the soak time.	024CH	40589	42589	0-5999 (00:00 to 99:59) (hour:min/min:sec)		00:00		
211	Sv-4	Ramp soak 4 seg/SV 4	Sets the SV	024DH	40590	42590	0 to 100%FS		0%FS	○	
212	TM4r	Ramp soak 4 seg ramp time	Sets the ramp time.	024EH	40591	42591	0-5999 (00:00 to 99:59) (hour:min/min:sec)		00:00		
213	TM4S	Ramp soak 4 seg soak time	Sets the soak time.	024FH	40592	42592	0-5999 (00:00 to 99:59) (hour:min/min:sec)		00:00		
214	Sv-5	Ramp soak 5 seg/SV 5	Sets the SV	0250 H	40593	42593	0 to 100%FS		0%FS	○	
215	TM5r	Ramp soak 5 seg ramp time	Sets the ramp time.	0251 H	40594	42594	0-5999 (00:00 to 99:59) (hour:min/min:sec)		00:00		
216	TM5S	Ramp soak 5 seg soak time	Sets the soak time.	0252 H	40595	42595	0-5999 (00:00 to 99:59) (hour:min/min:sec)		00:00		
217	Sv-6	Ramp soak 6 seg/SV 6	Sets the SV	0253 H	40596	42596	0 to 100%FS		0%FS	○	
218	TM6r	Ramp soak 6 seg ramp time	Sets the ramp time.	0254 H	40597	42597	0-5999 (00:00 to 99:59) (hour:min/min:sec)		00:00		
219	TM6S	Ramp soak 6 seg soak time	Sets the soak time.	0255 H	40598	42598	0-5999 (00:00 to 99:59) (hour:min/min:sec)		00:00		
220	Sv-7	Ramp soak 7 seg/SV 7	Sets the SV	0256 H	40599	42599	0 to 100%FS		0%FS	○	
221	TM7r	Ramp soak 7 seg ramp time	Sets the ramp time.	0257 H	40600	42600	0-5999 (00:00 to 99:59) (hour:min/min:sec)		00:00		
222	TM7S	Ramp soak 7 seg soak time	Sets the soak time.	0258 H	40601	42601	0-5999 (00:00 to 99:59) (hour:min/min:sec)		00:00		
223	Sv-8	Ramp soak 8 seg/SV 8	Sets the SV	0259 H	40602	42602	0 to 100%FS		0%FS	○	
224	TM8r	Ramp soak 8 seg ramp time	Sets the ramp time.	025AH	40603	42603	0-5999 (00:00 to 99:59) (hour:min/min:sec)		00:00		
225	TM8S	Ramp soak 8 seg soak time	Sets the soak time.	025BH	40604	42604	0-5999 (00:00 to 99:59) (hour:min/min:sec)		00:00		
226	Sv-9	Ramp soak 9 seg/SV 9	Sets the SV	025CH	40605	42605	0 to 100%FS		0%FS	○	
227	TM9r	Ramp soak 9 seg ramp time	Sets the ramp time.	025DH	40606	42606	0-5999 (00:00 to 99:59) (hour:min/min:sec)		00:00		
228	TM9S	Ramp soak 9 seg soak time	Sets the soak time.	025EH	40607	42607	0-5999 (00:00 to 99:59) (hour:min/min:sec)		00:00		
229	Sv10	Ramp soak 10 seg/SV 10	Sets the SV	025FH	40608	42608	0 to 100%FS		0%FS	○	
230	T10r	Ramp soak 10 seg ramp time	Sets the ramp time.	0260 H	40609	42609	0-5999 (00:00 to 99:59) (hour:min/min:sec)		00:00		
231	T10S	Ramp soak 10 seg soak time	Sets the soak time.	0261 H	40610	42610	0-5999 (00:00 to 99:59) (hour:min/min:sec)		00:00		
232	Sv11	Ramp soak 11 seg/SV 11	Sets the SV	0262 H	40611	42611	0 to 100%FS		0%FS	○	
233	T11r	Ramp soak 11 seg ramp time	Sets the ramp time.	0263 H	40612	42612	0-5999 (00:00 to 99:59) (hour:min/min:sec)		00:00		
234	T11S	Ramp soak 11 seg soak time	Sets the soak time.	0264 H	40613	42613	0-5999 (00:00 to 99:59) (hour:min/min:sec)		00:00		
235	Sv12	Ramp soak 12 seg/SV 12	Sets the SV	0265 H	40614	42614	0 to 100%FS		0%FS	○	
236	T12r	Ramp soak 12 seg ramp time	Sets the ramp time.	0266 H	40615	42615	0-5999 (00:00 to 99:59) (hour:min/min:sec)		00:00		
237	T12S	Ramp soak 12 seg soak time	Sets the soak time.	0267 H	40616	42616	0-5999 (00:00 to 99:59) (hour:min/min:sec)		00:00		
238	Sv13	Ramp soak 13 seg/SV 13	Sets the SV	0268 H	40617	42617	0 to 100%FS		0%FS	○	
239	T13r	Ramp soak 13 seg ramp time	Sets the ramp time.	0269 H	40618	42618	0-5999 (00:00 to 99:59) (hour:min/min:sec)		00:00		
240	T13S	Ramp soak 13 seg soak time	Sets the soak time.	026AH	40619	42619	0-5999 (00:00 to 99:59) (hour:min/min:sec)		00:00		

No.	Display	Value		Function	Relative address	Register No.		Read data	Written data range	Factory-set value	Dependent on range	Remarks
		Name				Internal	Engineering unit					
241	Sv14	Ramp soak 14 seg/SV 14		Sets the SV	026B H	40620	42620	0 to 100%FS		0%FS	○	
242	T14r	Ramp soak 14 seg ramp time		Sets the ramp time.	026C H	40621	42621	0-5999 (00:00 to 99:59) (hour:min/min:sec)		00:00		
243	T14S	Ramp soak 14 seg soak time		Sets the soak time.	026D H	40622	42622	0-5999 (00:00 to 99:59) (hour:min/min:sec)		00:00		
244	Sv15	Ramp soak 15 seg/SV 15		Sets the SV	026E H	40623	42623	0 to 100%FS		0%FS	○	
245	T15r	Ramp soak 15 seg ramp time		Sets the ramp time.	026F H	40624	42624	0-5999 (00:00 to 99:59) (hour:min/min:sec)		00:00		
246	T15S	Ramp soak 15 seg soak time		Sets the soak time.	0270 H	40625	42625	0-5999 (00:00 to 99:59) (hour:min/min:sec)		00:00		
247	Sv16	Ramp soak 16 seg/SV 16		Sets the SV	0271 H	40626	42626	0 to 100%FS		0%FS	○	
248	T16r	Ramp soak 16 seg ramp time		Sets the ramp time.	0272 H	40627	42627	0-5999 (00:00 to 99:59) (hour:min/min:sec)		00:00		
249	T16S	Ramp soak 16 seg soak time		Sets the soak time.	0273 H	40628	42628	0-5999 (00:00 to 99:59) (hour:min/min:sec)		00:00		
250	Sv17	Ramp soak 17 seg/SV 17		Sets the SV	0274 H	40629	42629	0 to 100%FS		0%FS	○	
251	T17r	Ramp soak 17 seg ramp time		Sets the ramp time.	0275 H	40630	42630	0-5999 (00:00 to 99:59) (hour:min/min:sec)		00:00		
252	T17S	Ramp soak 17 seg soak time		Sets the soak time.	0276 H	40631	42631	0-5999 (00:00 to 99:59) (hour:min/min:sec)		00:00		
253	Sv18	Ramp soak 18 seg/SV 18		Sets the SV	0277 H	40632	42632	0 to 100%FS		0%FS	○	
254	T18r	Ramp soak 18 seg ramp time		Sets the ramp time.	0278 H	40633	42633	0-5999 (00:00 to 99:59) (hour:min/min:sec)		00:00		
255	T18S	Ramp soak 18 seg soak time		Sets the soak time.	0279 H	40634	42634	0-5999 (00:00 to 99:59) (hour:min/min:sec)		00:00		
256	Sv19	Ramp soak 19 seg/SV 19		Sets the SV	027A H	40635	42635	0 to 100%FS		0%FS	○	
257	T19r	Ramp soak 19 seg ramp time		Sets the ramp time.	027B H	40636	42636	0-5999 (00:00 to 99:59) (hour:min/min:sec)		00:00		
258	T19S	Ramp soak 19 seg soak time		Sets the soak time.	027C H	40637	42637	0-5999 (00:00 to 99:59) (hour:min/min:sec)		00:00		
259	Sv20	Ramp soak 20 seg/SV 20		Sets the SV	027D H	40638	42638	0 to 100%FS		0%FS	○	
260	T20r	Ramp soak 20 seg ramp time		Sets the ramp time.	027E H	40639	42639	0-5999 (00:00 to 99:59) (hour:min/min:sec)		00:00		
261	T20S	Ramp soak 20 seg soak time		Sets the soak time.	027F H	40640	42640	0-5999 (00:00 to 99:59) (hour:min/min:sec)		00:00		
262	Sv21	Ramp soak 21 seg/SV 21		Sets the SV	0280 H	40641	42641	0 to 100%FS		0%FS	○	
263	T21r	Ramp soak 21 seg ramp time		Sets the ramp time.	0281 H	40642	42642	0-5999 (00:00 to 99:59) (hour:min/min:sec)		00:00		
264	T21S	Ramp soak 21 seg soak time		Sets the soak time.	0282 H	40643	42643	0-5999 (00:00 to 99:59) (hour:min/min:sec)		00:00		
265	Sv22	Ramp soak 22 seg/SV 22		Sets the SV	0283 H	40644	42644	0 to 100%FS		0%FS	○	
266	T22r	Ramp soak 22 seg ramp time		Sets the ramp time.	0284 H	40645	42645	0-5999 (00:00 to 99:59) (hour:min/min:sec)		00:00		
267	T22S	Ramp soak 22 seg soak time		Sets the soak time.	0285 H	40646	42646	0-5999 (00:00 to 99:59) (hour:min/min:sec)		00:00		
268	Sv23	Ramp soak 23 seg/SV 23		Sets the SV	0286 H	40647	42647	0 to 100%FS		0%FS	○	
269	T23r	Ramp soak 23 seg ramp time		Sets the ramp time.	0287 H	40648	42648	0-5999 (00:00 to 99:59) (hour:min/min:sec)		00:00		
270	T23S	Ramp soak 23 seg soak time		Sets the soak time.	0288 H	40649	42649	0-5999 (00:00 to 99:59) (hour:min/min:sec)		00:00		
271	Sv24	Ramp soak 24 seg/SV 24		Sets the SV	0289 H	40650	42650	0 to 100%FS		0%FS	○	
272	T24r	Ramp soak 24 seg ramp time		Sets the ramp time.	028A H	40651	42651	0-5999 (00:00 to 99:59) (hour:min/min:sec)		00:00		
273	T24S	Ramp soak 24 seg soak time		Sets the soak time.	028B H	40652	42652	0-5999 (00:00 to 99:59) (hour:min/min:sec)		00:00		
274	Sv25	Ramp soak 25 seg/SV 25		Sets the SV	028C H	40653	42653	0 to 100%FS		0%FS	○	
275	T25r	Ramp soak 25 seg ramp time		Sets the ramp time.	028D H	40654	42654	0-5999 (00:00 to 99:59) (hour:min/min:sec)		00:00		
276	T25S	Ramp soak 25 seg soak time		Sets the soak time.	028E H	40655	42655	0-5999 (00:00 to 99:59) (hour:min/min:sec)		00:00		
277	Sv26	Ramp soak 26 seg/SV 26		Sets the SV	028F H	40656	42656	0 to 100%FS		0%FS	○	
278	T26r	Ramp soak 26 seg ramp time		Sets the ramp time.	0290 H	40657	42657	0-5999 (00:00 to 99:59) (hour:min/min:sec)		00:00		
279	T26S	Ramp soak 26 seg soak time		Sets the soak time.	0291 H	40658	42658	0-5999 (00:00 to 99:59) (hour:min/min:sec)		00:00		
280	Sv27	Ramp soak 27 seg/SV 27		Sets the SV	0292 H	40659	42659	0 to 100%FS		0%FS	○	
281	T27r	Ramp soak 27 seg ramp time		Sets the ramp time.	0293 H	40660	42660	0-5999 (00:00 to 99:59) (hour:min/min:sec)		00:00		
282	T27S	Ramp soak 27 seg soak time		Sets the soak time.	0294 H	40661	42661	0-5999 (00:00 to 99:59) (hour:min/min:sec)		00:00		
283	Sv28	Ramp soak 28 seg/SV 28		Sets the SV	0295 H	40662	42662	0 to 100%FS		0%FS	○	
284	T28r	Ramp soak 28 seg ramp time		Sets the ramp time.	0296 H	40663	42663	0-5999 (00:00 to 99:59) (hour:min/min:sec)		00:00		
285	T28S	Ramp soak 28 seg soak time		Sets the soak time.	0297 H	40664	42664	0-5999 (00:00 to 99:59) (hour:min/min:sec)		00:00		
286	Sv29	Ramp soak 29 seg/SV 29		Sets the SV	0298 H	40665	42665	0 to 100%FS		0%FS	○	
287	T29r	Ramp soak 29 seg ramp time		Sets the ramp time.	0299 H	40666	42666	0-5999 (00:00 to 99:59) (hour:min/min:sec)		00:00		
288	T29S	Ramp soak 29 seg soak time		Sets the soak time.	029A H	40667	42667	0-5999 (00:00 to 99:59) (hour:min/min:sec)		00:00		
289	Sv30	Ramp soak 30 seg/SV 30		Sets the SV	029B H	40668	42668	0 to 100%FS		0%FS	○	
290	T30r	Ramp soak 30 seg ramp time		Sets the ramp time.	029C H	40669	42669	0-5999 (00:00 to 99:59) (hour:min/min:sec)		00:00		

No.	Display	Value		Function	Relative address	Register No.		Read data	Written data range	Factory-set value	Dependent on range	Remarks
		Name				Internal	Engineering unit					
291	T30S	Ramp soak 30 seg soak time		Sets the soak time.	029D H	40670	42670	0-5999 (00:00 to 99:59) (hour.min/min.sec)		00:00		
292	Sv31	Ramp soak 31 seg/SV 31		Sets the SV	029E H	40671	42671	0 to 100%FS		0%FS	○	
293	T31r	Ramp soak 31 seg ramp time		Sets the ramp time.	029F H	40672	42672	0-5999 (00:00 to 99:59) (hour.min/min.sec)		00:00		
294	T31S	Ramp soak 31 seg soak time		Sets the soak time.	02A0 H	40673	42673	0-5999 (00:00 to 99:59) (hour.min/min.sec)		00:00		
295	Sv32	Ramp soak 32 seg/SV 32		Sets the SV	02A1 H	40674	42674	0 to 100%FS		0%FS	○	
296	T32r	Ramp soak 32 seg ramp time		Sets the ramp time.	02A2 H	40675	42675	0-5999 (00:00 to 99:59) (hour.min/min.sec)		00:00		
297	T32S	Ramp soak 32 seg soak time		Sets the soak time.	02A3 H	40676	42676	0-5999 (00:00 to 99:59) (hour.min/min.sec)		00:00		
298	Sv33	Ramp soak 33 seg/SV 33		Sets the SV	02A4 H	40677	42677	0 to 100%FS		0%FS	○	
299	T33r	Ramp soak 33 seg ramp time		Sets the ramp time.	02A5 H	40678	42678	0-5999 (00:00 to 99:59) (hour.min/min.sec)		00:00		
300	T33S	Ramp soak 33 seg soak time		Sets the soak time.	02A6 H	40679	42679	0-5999 (00:00 to 99:59) (hour.min/min.sec)		00:00		
301	Sv34	Ramp soak 34 seg/SV 34		Sets the SV	02A7 H	40680	42680	0 to 100%FS		0%FS	○	
302	T34r	Ramp soak 34 seg ramp time		Sets the ramp time.	02A8 H	40681	42681	0-5999 (00:00 to 99:59) (hour.min/min.sec)		00:00		
303	T34S	Ramp soak 34 seg soak time		Sets the soak time.	02A9 H	40682	42682	0-5999 (00:00 to 99:59) (hour.min/min.sec)		00:00		
304	Sv35	Ramp soak 35 seg/SV 35		Sets the SV	02AA H	40683	42683	0 to 100%FS		0%FS	○	
305	T35r	Ramp soak 35 seg ramp time		Sets the ramp time.	02AB H	40684	42684	0-5999 (00:00 to 99:59) (hour.min/min.sec)		00:00		
306	T35S	Ramp soak 35 seg soak time		Sets the soak time.	02AC H	40685	42685	0-5999 (00:00 to 99:59) (hour.min/min.sec)		00:00		
307	Sv36	Ramp soak 36 seg/SV 36		Sets the SV	02AD H	40686	42686	0 to 100%FS		0%FS	○	
308	T36r	Ramp soak 36 seg ramp time		Sets the ramp time.	02AE H	40687	42687	0-5999 (00:00 to 99:59) (hour.min/min.sec)		00:00		
309	T36S	Ramp soak 36 seg soak time		Sets the soak time.	02AF H	40688	42688	0-5999 (00:00 to 99:59) (hour.min/min.sec)		00:00		
310	Sv37	Ramp soak 37 seg/SV 37		Sets the SV	02B0 H	40689	42689	0 to 100%FS		0%FS	○	
311	T37r	Ramp soak 37 seg ramp time		Sets the ramp time.	02B1 H	40690	42690	0-5999 (00:00 to 99:59) (hour.min/min.sec)		00:00		
312	T37S	Ramp soak 37 seg soak time		Sets the soak time.	02B2 H	40691	42691	0-5999 (00:00 to 99:59) (hour.min/min.sec)		00:00		
313	Sv38	Ramp soak 38 seg/SV 38		Sets the SV	02B3 H	40692	42692	0 to 100%FS		0%FS	○	
314	T38r	Ramp soak 38 seg ramp time		Sets the ramp time.	02B4 H	40693	42693	0-5999 (00:00 to 99:59) (hour.min/min.sec)		00:00		
315	T38S	Ramp soak 38 seg soak time		Sets the soak time.	02B5 H	40694	42694	0-5999 (00:00 to 99:59) (hour.min/min.sec)		00:00		
316	Sv39	Ramp soak 39 seg/SV 39		Sets the SV	02B6 H	40695	42695	0 to 100%FS		0%FS	○	
317	T39r	Ramp soak 39 seg ramp time		Sets the ramp time.	02B7 H	40696	42696	0-5999 (00:00 to 99:59) (hour.min/min.sec)		00:00		
318	T39S	Ramp soak 39 seg soak time		Sets the soak time.	02B8 H	40697	42697	0-5999 (00:00 to 99:59) (hour.min/min.sec)		00:00		
319	Sv40	Ramp soak 40 seg/SV 40		Sets the SV	02B9 H	40698	42698	0 to 100%FS		0%FS	○	
320	T40r	Ramp soak 40 seg ramp time		Sets the ramp time.	02BA H	40699	42699	0-5999 (00:00 to 99:59) (hour.min/min.sec)		00:00		
321	T40S	Ramp soak 40 seg soak time		Sets the soak time.	02BB H	40700	42700	0-5999 (00:00 to 99:59) (hour.min/min.sec)		00:00		
322	Sv41	Ramp soak 41 seg/SV 41		Sets the SV	02BC H	40701	42701	0 to 100%FS		0%FS	○	
323	T41r	Ramp soak 41 seg ramp time		Sets the ramp time.	02BD H	40702	42702	0-5999 (00:00 to 99:59) (hour.min/min.sec)		00:00		
324	T41S	Ramp soak 41 seg soak time		Sets the soak time.	02BE H	40703	42703	0-5999 (00:00 to 99:59) (hour.min/min.sec)		00:00		
325	Sv42	Ramp soak 42 seg/SV 42		Sets the SV	02BF H	40704	42704	0 to 100%FS		0%FS	○	
326	T42r	Ramp soak 42 seg ramp time		Sets the ramp time.	02C0 H	40705	42705	0-5999 (00:00 to 99:59) (hour.min/min.sec)		00:00		
327	T42S	Ramp soak 42 seg soak time		Sets the soak time.	02C1 H	40706	42706	0-5999 (00:00 to 99:59) (hour.min/min.sec)		00:00		
328	Sv43	Ramp soak 43 seg/SV 43		Sets the SV	02C2 H	40707	42707	0 to 100%FS		0%FS	○	
329	T43r	Ramp soak 43 seg ramp time		Sets the ramp time.	02C3 H	40708	42708	0-5999 (00:00 to 99:59) (hour.min/min.sec)		00:00		
330	T43S	Ramp soak 43 seg soak time		Sets the soak time.	02C4 H	40709	42709	0-5999 (00:00 to 99:59) (hour.min/min.sec)		00:00		
331	Sv44	Ramp soak 44 seg/SV 44		Sets the SV	02C5 H	40710	42710	0 to 100%FS		0%FS	○	
332	T44r	Ramp soak 44 seg ramp time		Sets the ramp time.	02C6 H	40711	42711	0-5999 (00:00 to 99:59) (hour.min/min.sec)		00:00		
333	T44S	Ramp soak 44 seg soak time		Sets the soak time.	02C7 H	40712	42712	0-5999 (00:00 to 99:59) (hour.min/min.sec)		00:00		
334	Sv45	Ramp soak 45 seg/SV 45		Sets the SV	02C8 H	40713	42713	0 to 100%FS		0%FS	○	
335	T45r	Ramp soak 45 seg ramp time		Sets the ramp time.	02C9 H	40714	42714	0-5999 (00:00 to 99:59) (hour.min/min.sec)		00:00		
336	T45S	Ramp soak 45 seg soak time		Sets the soak time.	02CA H	40715	42715	0-5999 (00:00 to 99:59) (hour.min/min.sec)		00:00		
337	Sv46	Ramp soak 46 seg/SV 46		Sets the SV	02CB H	40716	42716	0 to 100%FS		0%FS	○	
338	T46r	Ramp soak 46 seg ramp time		Sets the ramp time.	02CC H	40717	42717	0-5999 (00:00 to 99:59) (hour.min/min.sec)		00:00		
339	T46S	Ramp soak 46 seg soak time		Sets the soak time.	02CD H	40718	42718	0-5999 (00:00 to 99:59) (hour.min/min.sec)		00:00		
340	Sv47	Ramp soak 47 seg/SV 47		Sets the SV	02CE H	40719	42719	0 to 100%FS		0%FS	○	

No.	Display	Value	Function	Relative address	Register No.		Read data	Written data range	Factory-set value	Dependent on range	Remarks
		Name			Internal	Engineering unit					
341	T47r	Ramp soak 47 seg ramp time	Sets the ramp time.	02CFH	40720	42720	0-5999 (00:00 to 99:59) (hour.min/min.sec)		00:00		
342	T47S	Ramp soak 47 seg soak time	Sets the soak time.	02D0H	40721	42721	0-5999 (00:00 to 99:59) (hour.min/min.sec)		00:00		
343	Sv48	Ramp soak 48 seg/SV 48	Sets the SV	02D1H	40722	42722	0 to 100%FS		0%FS	○	
344	T48r	Ramp soak 48 seg ramp time	Sets the ramp time.	02D2H	40723	42723	0-5999 (00:00 to 99:59) (hour.min/min.sec)		00:00		
345	T48S	Ramp soak 48 seg soak time	Sets the soak time.	02D3H	40724	42724	0-5999 (00:00 to 99:59) (hour.min/min.sec)		00:00		
346	Sv49	Ramp soak 49 seg/SV 49	Sets the SV	02D4H	40725	42725	0 to 100%FS		0%FS	○	
347	T49r	Ramp soak 49 seg ramp time	Sets the ramp time.	02D5H	40726	42726	0-5999 (00:00 to 99:59) (hour.min/min.sec)		00:00		
348	T49S	Ramp soak 49 seg soak time	Sets the soak time.	02D6H	40727	42727	0-5999 (00:00 to 99:59) (hour.min/min.sec)		00:00		
349	Sv50	Ramp soak 50 seg/SV 50	Sets the SV	02D7H	40728	42728	0 to 100%FS		0%FS	○	
350	T50r	Ramp soak 50 seg ramp time	Sets the ramp time.	02D8H	40729	42729	0-5999 (00:00 to 99:59) (hour.min/min.sec)		00:00		
351	T50S	Ramp soak 50 seg soak time	Sets the soak time.	02D9H	40730	42730	0-5999 (00:00 to 99:59) (hour.min/min.sec)		00:00		
352	Sv51	Ramp soak 51 seg/SV 51	Sets the SV	02DAH	40731	42731	0 to 100%FS		0%FS	○	
353	T51r	Ramp soak 51 seg ramp time	Sets the ramp time.	02DBH	40732	42732	0-5999 (00:00 to 99:59) (hour.min/min.sec)		00:00		
354	T51S	Ramp soak 51 seg soak time	Sets the soak time.	02DCH	40733	42733	0-5999 (00:00 to 99:59) (hour.min/min.sec)		00:00		
355	Sv52	Ramp soak 52 seg/SV 52	Sets the SV	02DDH	40734	42734	0 to 100%FS		0%FS	○	
356	T52r	Ramp soak 52 seg ramp time	Sets the ramp time.	02DEH	40735	42735	0-5999 (00:00 to 99:59) (hour.min/min.sec)		00:00		
357	T52S	Ramp soak 52 seg soak time	Sets the soak time.	02DFH	40736	42736	0-5999 (00:00 to 99:59) (hour.min/min.sec)		00:00		
358	Sv53	Ramp soak 53 seg/SV 53	Sets the SV	02E0H	40737	42737	0 to 100%FS		0%FS	○	
359	T53r	Ramp soak 53 seg ramp time	Sets the ramp time.	02E1H	40738	42738	0-5999 (00:00 to 99:59) (hour.min/min.sec)		00:00		
360	T53S	Ramp soak 53 seg soak time	Sets the soak time.	02E2H	40739	42739	0-5999 (00:00 to 99:59) (hour.min/min.sec)		00:00		
361	Sv54	Ramp soak 54 seg/SV 54	Sets the SV	02E3H	40740	42740	0 to 100%FS		0%FS	○	
362	T54r	Ramp soak 54 seg ramp time	Sets the ramp time.	02E4H	40741	42741	0-5999 (00:00 to 99:59) (hour.min/min.sec)		00:00		
363	T54S	Ramp soak 54 seg soak time	Sets the soak time.	02E5H	40742	42742	0-5999 (00:00 to 99:59) (hour.min/min.sec)		00:00		
364	Sv55	Ramp soak 55 seg/SV 55	Sets the SV	02E6H	40743	42743	0 to 100%FS		0%FS	○	
365	T55r	Ramp soak 55 seg ramp time	Sets the ramp time.	02E7H	40744	42744	0-5999 (00:00 to 99:59) (hour.min/min.sec)		00:00		
366	T55S	Ramp soak 55 seg soak time	Sets the soak time.	02E8H	40745	42745	0-5999 (00:00 to 99:59) (hour.min/min.sec)		00:00		
367	Sv56	Ramp soak 56 seg/SV 56	Sets the SV	02E9H	40746	42746	0 to 100%FS		0%FS	○	
368	T56r	Ramp soak 56 seg ramp time	Sets the ramp time.	02EAH	40747	42747	0-5999 (00:00 to 99:59) (hour.min/min.sec)		00:00		
369	T56S	Ramp soak 56 seg soak time	Sets the soak time.	02EBH	40748	42748	0-5999 (00:00 to 99:59) (hour.min/min.sec)		00:00		
370	Sv57	Ramp soak 57 seg/SV 57	Sets the SV	02ECH	40749	42749	0 to 100%FS		0%FS	○	
371	T57r	Ramp soak 57 seg ramp time	Sets the ramp time.	02EDH	40750	42750	0-5999 (00:00 to 99:59) (hour.min/min.sec)		00:00		
372	T57S	Ramp soak 57 seg soak time	Sets the soak time.	02EBH	40751	42751	0-5999 (00:00 to 99:59) (hour.min/min.sec)		00:00		
373	Sv58	Ramp soak 58 seg/SV 58	Sets the SV	02EFH	40752	42752	0 to 100%FS		0%FS	○	
374	T58r	Ramp soak 58 seg ramp time	Sets the ramp time.	02F0H	40753	42753	0-5999 (00:00 to 99:59) (hour.min/min.sec)		00:00		
375	T58S	Ramp soak 58 seg soak time	Sets the soak time.	02F1H	40754	42754	0-5999 (00:00 to 99:59) (hour.min/min.sec)		00:00		
376	Sv59	Ramp soak 59 seg/SV 59	Sets the SV	02F2H	40755	42755	0 to 100%FS		0%FS	○	
377	T59r	Ramp soak 59 seg ramp time	Sets the ramp time.	02F3H	40756	42756	0-5999 (00:00 to 99:59) (hour.min/min.sec)		00:00		
378	T59S	Ramp soak 59 seg soak time	Sets the soak time.	02F4H	40757	42757	0-5999 (00:00 to 99:59) (hour.min/min.sec)		00:00		
379	Sv60	Ramp soak 60 seg/SV 60	Sets the SV	02F5H	40758	42758	0 to 100%FS		0%FS	○	
380	T60r	Ramp soak 60 seg ramp time	Sets the ramp time.	02F6H	40759	42759	0-5999 (00:00 to 99:59) (hour.min/min.sec)		00:00		
381	T60S	Ramp soak 60 seg soak time	Sets the soak time.	02F7H	40760	42760	0-5999 (00:00 to 99:59) (hour.min/min.sec)		00:00		
382	Sv61	Ramp soak 61 seg/SV 61	Sets the SV	02F8H	40761	42761	0 to 100%FS		0%FS	○	
383	T61r	Ramp soak 61 seg ramp time	Sets the ramp time.	02F9H	40762	42762	0-5999 (00:00 to 99:59) (hour.min/min.sec)		00:00		
384	T61S	Ramp soak 61 seg soak time	Sets the soak time.	02FAH	40763	42763	0-5999 (00:00 to 99:59) (hour.min/min.sec)		00:00		
385	Sv62	Ramp soak 62 seg/SV 62	Sets the SV	02FBH	40764	42764	0 to 100%FS		0%FS	○	
386	T62r	Ramp soak 62 seg ramp time	Sets the ramp time.	02FCH	40765	42765	0-5999 (00:00 to 99:59) (hour.min/min.sec)		00:00		
387	T62S	Ramp soak 62 seg soak time	Sets the soak time.	02FDH	40766	42766	0-5999 (00:00 to 99:59) (hour.min/min.sec)		00:00		
388	Sv63	Ramp soak 63 seg/SV 63	Sets the SV	02FEH	40767	42767	0 to 100%FS		0%FS	○	
389	T63r	Ramp soak 63 seg ramp time	Sets the ramp time.	02FFH	40768	42768	0-5999 (00:00 to 99:59) (hour.min/min.sec)		00:00		
390	T63S	Ramp soak 63 seg soak time	Sets the soak time.	0300H	40769	42769	0-5999 (00:00 to 99:59) (hour.min/min.sec)		00:00		

Value			Function	Relative address	Register No.		Read data	Written data range	Factory-set value	Dependent on range	Remarks
No.	Display	Name			Internal	Engineering unit					
391	Sv64	Ramp soak 64 seg/SV 64	Sets the SV	0301 H	40770	42770	0 to 100%FS		0%FS	○	
392	T64r	Ramp soak 64 seg ramp time	Sets the ramp time.	0302 H	40771	42771	0-5999 (00:00 to 99:59) (hour:min:min:sec)		00:00		
393	T64S	Ramp soak 64 seg soak time	Sets the soak time.	0303 H	40772	42772	0-5999 (00:00 to 99:59) (hour:min:min:sec)		00:00		
394	Mod	Ramp soak mode	Sets the program operation method	0050 H	40081	42081	0 to 15		0		
395	GSok	Guaranty soak ON/OFF	Sets the guaranty soak ON or OFF	023A H	40571	42571	0: oFF (guaranty soak off) 1: on (guaranty soak on)		oFF		
396	GS-L	Guaranty soak band (Lower)	Sets the lower limit of guaranty soak	023B H	40572	42572	0 to 50%FS		1.25%FS	○	
397	GS-h	Guaranty soak band (Upper)	Sets the upper limit of guaranty soak	023C H	40573	42573	0 to 50%FS		1.25%FS	○	
398	PvST	PV start	Sets whether or not to start ramp soak with PV.	023D H	40574	42574	0: oFF (PV start off) 1: on (PV start on)		oFF		
399	ConT	Restore mode	Sets how to restart when the controller is restored after a power loss.	023E H	40575	42575	0: rES (Reset) 1: Con (Continue) 2: ini (Restart)		rES		
400	PtNM	Max pattern selection	Sets the maximum pattern number selectable by using the user key.	0233 H	40564	42564	0 to 14		14		
401	PNin	Min pattern selection	Sets the minimum pattern number selectable by using the user key.	0234 H	40565	42565	0 to 14		0		

Note 1: Do not change this parameter during the ramp soak operation. Be sure to set "PrG" = "oFF" before changing the parameter.



## Ch 5 ALM (alarm parameters)

No.	Display	Value		Function	Relative address	Register No.		Read data	Written data range	Factory-set value	Dependent on range	Remarks
		Name				Internal	Engineering unit					
470	A1Tp	ALM1 alarm type		Set the alarm type for ALM1.	00A1 H	40162	42162	0 to 47		0		
471	A1hy	ALM1 hysteresis		Sets the hysteresis for alarm output 1 ON/OFF	00A4 H	40165	42165	0 to 50%FS		0.25%FS	○	
472	dLy1	ALM1 delay		Sets the delay before detecting alarm output 1	00A6 H	40167	42167	0 to 9999[sec/min]		0		
473	dL1U	ALM1 delay time unit		Sets the delay time unit for alarm output 1	00A7 H	40168	42168	0: sec (second) 1: Min (minute)		sec		
474	AoP1	ALM1 option		Assigns the optional functions to ALM1. Ones digit: alarm output latch Tens digit: error alarm Hundreds digit: inverted output Thousands digit: hold reset	00A8 H	40169	42169	0 - 15 (0000 - 1111)		0000		
475	A2Tp	ALM2 alarm type		Set the alarm type for ALM2.	00A1 H	40162	42162	0 to 47		0		
476	A2hy	ALM2 hysteresis		Sets the hysteresis for alarm output 2 ON/OFF	00A4 H	40165	42165	0 to 50%FS		0.25%FS	○	
477	dLy2	ALM2 delay		Sets the delay before detecting alarm output 2	00A6 H	40167	42167	0 to 9999[sec/min]		0		
478	dL2U	ALM2 delay time unit		Sets the delay time unit for alarm output 2	00A7 H	40168	42168	0: sec (second) 1: Min (minute)		sec		
479	AoP2	ALM2 option		Assigns the optional functions to ALM2 Ones digit: alarm latch bit mask Tens digit: error alarm bit mask Hundreds digit: inverted output bit mask Thousands digit: hold reset bit mask	00A5 H	40166	42166	0 - 15 (0000 - 1111)		0000		
480	A3Tp	ALM3 alarm type		Set the alarm type for ALM3.	00A8 H	40169	42169	0 to 47		0		
481	A3hy	ALM3 hysteresis		Sets the hysteresis width for the ON/OFF control.	00AB H	40172	42172	0 to 50%FS		0.25%FS	○	
482	dLy3	ALM3 delay		Sets the delay before detecting alarm output 3	00AD H	40174	42174	0 to 9999[sec/min]		0		
483	dL3U	ALM3 delay time unit		Sets the delay time unit for alarm output 3	00AE H	40175	42175	0: sec (second) 1: Min (minute)		sec		
484	AoP3	ALM3 option		Assigns the optional functions to ALM3 Ones digit: alarm output latch Tens digit: error alarm Hundreds digit: inverted output Thousands digit: hold reset	00AC H	40173	42173	0 - 15 (0000 - 1111)		0000		
485	A4Tp	ALM4 alarm type		Set the alarm type for ALM4.	00B6 H	40183	42183	0 to 47		0		
486	A4hy	ALM4 hysteresis		Sets the ON/OFF hysteresis for alarm 4.	00B9 H	40186	42186	0 to 50%FS		0.25%FS	○	
487	dLy4	ALM4 delay		Sets the delay before activating alarm 4.	00BB H	40188	42188	0 to 9999[sec/min]		0		
488	dL4U	ALM4 delay time units		Sets the delay time unit for alarm 4.	00BC H	40189	42189	0: sec (second) 1: Min (minute)		sec		
489	AoP4	ALM4 option		Assigns the optional functions to ALM4. Ones digit: alarm output latch Tens digit: error alarm Hundreds digit: inverted output Thousands digit: hold reset	00BA H	40187	42187	0 - 15 (0000 - 1111)		0000		
490	A5Tp	ALM5 alarm type		Set the alarm type for ALM5.	00BD H	40190	42190	0 to 47		0		
491	A5hy	ALM5 hysteresis		Sets the ON/OFF hysteresis for alarm 5.	00C0 H	40193	42193	0 to 50%FS		0.25%FS	○	
492	dLy5	ALM5 delay		Sets the delay before activating alarm 5.	00C2 H	40195	42195	0 to 9999[sec/min]		0		
493	dL5U	ALM5 delay time units		Sets the delay time unit for alarm 5.	00C3 H	40196	42196	0: sec (second) 1: Min (minute)		sec		
494	AoP5	ALM5 option		Assigns the optional functions to ALM5 Ones digit: alarm output latch Tens digit: error alarm Hundreds digit: inverted output Thousands digit: hold reset	00C1 H	40194	42194	0 - 15 (0000 - 1111)		0000		
500	hb1	HB alarm set value (for CT1)		Sets the value to activate the heater burnout alarm for CT1.	00CB H	40204	42204	0-1000 (0.0 to 100.0 A)		0.0A		
501	hb1h	HB alarm hysteresis (for CT1)		Sets the ON/OFF hysteresis for the heater burnout alarm for CT1.	00CC H	40205	42205	0-1000 (0.0 to 100.0 A)		0.5 A		
502	hS1	Shorted-load alarm set value (for CT1)		Sets the value to activate the shorted load alarm for CT1.	00CD H	40206	42206	0-1000 (0.0 to 100.0 A)		0.0 A		
503	hS1h	Shorted-load alarm hysteresis for CT1		Sets the ON/OFF hysteresis for the shorted heater-load alarm for CT1.	00CE H	40207	42207	0-1000 (0.0 to 100.0 A)		0.5 A		
508	LbTM	Loop break detection time		Sets the time before detecting a broken	00D3 H	40212	42212	0 to 9999 (0 to 9999 sec)		oFF		
509	LbAb	Loop break detector detection range (°C)		Sets the temperature range before detecting a broken loop	00D4 H	40213	42213	0.0 to 100.0%FS		2.50%FS	○	
511	WHAL	Electricity alarm		Sets the value for electricity alarm.	00D6 H	40215	42215	0 to 9999 (kWh)		0		



## CH 6 SET (setup parameters)

No.	Display	Value		Function	Relative address	Register No.		Read data	Written data range	Factory-set value	Dependent on range	Remarks
		Name				Internal	Engineering unit					
530	PvT	PV input type		Sets the type of input sensor	000F H	40016	42016	0: JPT1: 0.0 to 150.0°C 1: JPT2: 0.0 to 300.0°C 2: JPT3: 0.0 to 500.0°C 3: JPT4: 0.0 to 600.0°C 4: JPT5: -50.0 to 100.0°C 5: JPT6: -100.0 to 200.0°C 6: JPT7: -199.9 to 600.0°C 7: PT1: 0.0 to 150.0°C 8: PT2: 0.0 to 300.0°C 9: PT3: 0.0 to 500.0°C 10: PT4: 0.0 to 600.0°C 11: PT5: -50.0 to 100.0°C 12: PT6: -100.0 to 200.0°C 13: PT7: -199.9 to 600.0°C 14: PT8: -200 to 850°C 15: J1: 0.0 to 400.0°C 16: J2: -20.0 to 400.0°C 17: J3: 0.0 to 800.0°C 18: J4: -200 to 1300°C 19: K1: 0 to 400°C 20: K2: -20.0 to 500.0°C 21: K3: 0.0 to 800.0°C 22: K4: -200 to 1300°C 23: R: 0 to 1700°C 24: B: 0 to 1800°C 25: S: 0 to 1700°C 26: T1: -199.9 to 200.0°C 27: T2: -199.9 to 400.0°C 28: E1: 0.0 to 800.0°C 29: E2: -150.0 to 800.0°C 30: E3: -200 to 800°C 31: L: -100 to 850°C 32: U1: -199.9 to 400.0°C 33: U2: -200 to 400°C 34: N: -200 to 1300°C 35: W: 0 to 2300°C 36: PL-2: 0 to 1300°C 37: 0-5 V: 0 to 5 V 38: 1-5 V: 1 to 5 V 39: 0-10: 0 to 10 V 40: 2-10: 2 to 10 V 41: MV: 0 to 100 mV 42: 0-20: 0 to 20 mA 43: 4-20: 4 to 20 mA		K1		[RESET]
531	Pvb	PV input lower limit		Sets the lower limit of PV input	0011 H	40018	42018	-1999 to 9999		0		[RESET]
532	PvF	PV input upper limit		Sets the upper limit of PV input	0012 H	40019	42019	-1999 to 9999		400		[RESET]
533	Pvd	Decimal point position		Sets the decimal point position for the PV/SV	0013 H	40020	42020	0: No digit after decimal point 1: 1 digit after decimal point 2: 2 digit after decimal point 3: 3 digit after decimal point		0		[RESET]
534	PvU	Unit		Sets the unit for the PV/SV display.	0010 H	40017	42017	0: °C 1: °F		°C		
535	CUT	Square-root extractor cut point		Sets the cut point for square root calculation.	0159 H	40346	42346	-10 to 1050 (-0.1 to 105.0%)		-0.1%		
536	PvoF	PV input shift		Sets the amount of shift for PV input	000D H	40014	42014	-10 to 10%FS		0.00%FS	○	
537	SvoF	SV shift		Sets the amount of shift for PV input.	000E H	40015	42015	-50 to 50%FS		0.00%FS	○	
538	TF	PV input filter		Sets the time constant for the PV input filter	0015 H	40022	42022	0 to 1200 (0.0 to -120.0 sec)		5.0 sec		
539	AdJ0	PV display zero adjustment		Adjusts zero side of PV display.	0062 H	40099	42099	-50 to 50%FS		0.00%FS	○	
540	AdJS	PV display span adjustment		Adjusts span side of PV display.	0063 H	40100	42100	-50 to 50%FS		0.00%FS	○	
541	rCJ	Cold junction compensation		Sets on/off of cold junction compensation.	0016 H	40023	42023	0: oFF (none) 1: on		oN		
543	REMO	Remote SV zero adjustment		Adjusts the zero side of the remote SV input.	0163 H	40356	42356	-50 to 50%FS		0.00%FS		
544	REMS	Remote SV span adjustment		Adjusts the span side of the remote SV input.	0164 H	40357	42357	-50 to 50%FS		0.00%FS		
545	REMR	Remote SV input range		Sets the range for remote SV input.	0165 H	40358	42358	0: 0 to 5 V 1: 1 to 5 V 2: 0 to 10 V 3: 2 to 10 V		1-5V		
546	RtF	Remote SV input filter		Sets the time constant for the RSV input filter	0166 H	40359	42359	0 to 1200 (0.0 to 120.0 sec)		0		
547	C1r	OUT1 range		Sets the range of the control output 1(OUT1)	017C H	40381	42381	0: 0-5V (0 to 5 V) 1: 1-5V (1 to 5 V) 2: 0-10 (0 to 10) 3: 2-10 (2 to 10) 4: 0-20 (0 to 20 mA) 5: 4-20 (4 to 20 mA)		0-10 (voltage) 4-20 (current)		Displayed when OUT1 is current output.

No.	Display	Value	Function	Relative address	Register No.		Read data	Written data range	Factory-set value	Dependent on range	Remarks
		Name			Internal	Engineering unit					
548	C2R	OUT2 range	Sets the range of the control output 2 (OUT2).	017D H	40382	42382	0: 0 to 5 V 1: 1 to 5 V 2: 0 to 10 V 3: 2 to 10 V 4: 0 to 20 mA 5: 4 to 20 mA	0-10 (voltage) 4-20 (current)			Displayed when the control output 2 is current or voltage output.
549	FLo1	MV1 during FALT	Sets the output value for the control output (MV1) during FALT	0185 H	40390	42390	-500 to 10500 (-5.0 to 105.0%)	-5.0%			
550	FLo2	MV2 during FALT	Sets the output value for the control output (MV2) during FALT	0186 H	40391	42391	-500 to 10500 (-5.0 to 105.0%)	-5.0%			
551	SFo1	MV1 during Soft Start	Sets the value for the control output (MV1) during soft start	0187 H	40392	42392	-500 to 10500 (-5.0 to 105.0%)	105.0%			
553	SFTM	Soft Start set time	Sets the time from startup to the finish of soft start	0189 H	40394	42394	0-5999 (00:00-99:59 (hour:min))	00:00			Be sure to set 0.00 during dual control.
554	Sbo1	MV1 during standby	Sets the value for the control output (MV1) during standby	018D H	40398	42398	-500 to 10500 (-5.0 to 105.0%)	-5.0%			
555	Sbo2	MV2 during standby	Sets the value for the control output (MV2) during standby	018E H	40399	42399	-500 to 10500 (-5.0 to 105.0%)	-5.0%			
556	SbMd	Startup mode	Sets on/off of the alarm output during standby	018F H	40400	42400	0: ALM=OFF, AO=ON 1: ALM = ON, AO = ON 2: ALM = OFF, AO = OFF 3: ALM = ON, AO = OFF	0			[RESET]
557	AoT	AO output type	Selects what to transfer to the analog output.	0190 H	40401	42401	0: PV 1: SV 2: MV 3: DV 4: Pfb	PV			
558	AoL	AO lower scaling	Sets the AO lower scaling	0191 H	40402	42402	-10000 to 10000 (-100.0 to 100.0%)	0.0%			
559	AoH	AO upper scaling	Sets the AO upper scaling	0192 H	40403	42403	-10000 to 10000 (-100.0 to 100.0%)	100.0%			
561	VoLt	Fixed voltage value	Sets the voltage for calculating electric power	0321 H	40802	42802	1-500 (1 to 500 V)	100V			
562	CUR	Current value for simple power calculation	Sets the current value for simple power calculation When set to 0.0, the value measured at CT is used for calculation.	0322H	40803	42803	0-1000 (0.0 to 100.0 A)	0.0A			
564	WdP	Decimal point position for electric power	Sets the position of decimal point for calculated amount of electric power.	0324H	40805	42805	0: 0 1: 0.1 2: 0.01 3: 0.001	0.1			Do not change it during calculation.
565	Phy	Power factor for simple calculation	Sets the power factor for simple calculation.	0325H	40806	42806	0 to 100 (0.00 to 1.00)	1.00			
566	RyCn	Upper limit of relay contact operation	Sets the upper limit on the number of times a relay contact can operate. If you set it to 0, no alarm will be generated.	0326H	40807	42807	0 to 9999 (0 to 9999 K times)	10 K times			
567	OpTm	Upper limit of operation days	Sets the upper limit on the number of days that the device can operate. If you set it to 0, no alarm will be generated.	0327H	40808	42808	0 to 5000 (0 to 5000 days)	3650 days			

## Ch 7 SYS (system parameters)

No.	Display	Value		Function	Relative address	Register No.		Read data	Written data range	Factory-set value	Dependent on range	Remarks
		Name				Internal	Engineering unit					
590	Uky1	USER key		Assigns the function to the [USER] key	008A H	40139	42139	0 to 27		0		
591	Uky2	USER + UP key		Assigns the function to the [USER]+ ^ key	008B H	40140	42140	0 to 27		5		
592	Uky3	USER + DOWN key		Assigns the function to the [USER]+ v key	008C H	40141	42141	0 to 27		1		
593	di1	DI-1 function		Allocates a function to DI-1.	008E H	40143	42143	0-48		0		
594	di2	DI-2 function		Allocates a function to DI-2.	008F H	40144	42144	0-48		0		
595	di3	DI-3 function		Allocates a function to DI-3.	0090 H	40145	42145	0-48		0		
596	di4	DI-4 function		Allocates a function to DI-4.	0091 H	40146	42146	0-48		0		
597	di5	DI-5 function		Allocates a function to DI-5.	0092 H	40147	42147	0-48		0		
599	oU1T	OUT1 output type		Selects the content to be output from OUT1	0193 H	40404	42404	0 to 427		1		
600	oU2T	OUT2 output type		Selects the content to be output from OUT2	0194 H	40405	42405	0 to 427		2		
601	do1T	DO1 output type		Selects the content to be output from DO1.	0195 H	40406	42406	0 to 427		3		
602	do2T	DO2 output type		Selects the content to be output from DO2.	0196 H	40407	42407	0 to 427		4		
603	do3T	DO3 output type		Selects the content to be output from DO3.	0197 H	40408	42408	0 to 427		5		
604	do4T	DO4 output type		Selects the content to be output from DO4.	0198 H	40409	42409	0 to 427		6		
605	do5T	DO5 output type		Selects the content to be output from DO5.	0199 H	40410	42410	0 to 427		7		
607	LoU1	LED indicator assignment (OUT1)		Selects the content for OUT1 to indicate.	021C H	40541	42541	0 to 427		1		
608	LoU2	LED indicator assignment (OUT2)		Selects the content for OUT2 to indicate.	021D H	40542	42542	0 to 427		2		
609	LEv1	LED indicator assignment (Ev1)		Selects the content for EV1 to indicate.	021E H	40543	42543	0 to 427		3		
610	LEv2	LED indicator assignment (Ev2)		Selects the content for EV2 to indicate.	021F H	40544	42544	0 to 427		4		
611	LEv3	LED indicator assignment (Ev3)		Selects the content for EV3 to indicate.	0220 H	40545	42545	0 to 427		5		
612	LEv4	LED indicator assignment (Ev4)		Selects the content for EV4 lamp to indicate.	0221 H	40546	42546	0 to 427		6		
613	LEv5	LED indicator assignment (Ev5)		Selects the content for EV5 lamp to indicate.	0222 H	40547	42547	0 to 427		7		
614	LEv6	LED indicator assignment (Ev6)		Selects the content for EV6 lamp to indicate.	0223 H	40548	42548	0 to 427		0		
615	LSTb	LED indicator assignment (STBY)		Selects the content for STBY to indicate.	0224 H	40549	42549	0 to 427		12		
616	LMAn	LED indicator assignment (MANU)		Selects the content for MANU to indicate.	0225 H	40550	42550	0 to 427		13		
617	rMP	Ramp SV ON/OFF		Sets the ramp SV ON/OFF	01ACH	40429	42429	0: oFF 1: oN		oN		
618	rMPL	Ramp SV-Decline		Sets the slope for a falling SV during ramp SV operations	01ADH	40430	42430	0 to 100%FS		0.00%FS	○	
619	rMPh	Ramp SV-Incline		Sets the slope for a rising SV during ramp SV operations	01AEH	40431	42431	0 to 100%FS		0.00%FS	○	
620	rMPU	Ramp SV-slope time unit		Sets the unit of time for the slope during ramp SV operations	01AFH	40432	42432	0: hoUr (slope temperature/hour) 1: Min (slope temperature/min)		hoUr		
621	SVt	Ramp SV - display mode		Selects which to display between the SV during ramp operations or the SV goal value.	01B0H	40433	42433	0: rMP (ramping SV) 1: TrG (target SV)		rMP		
622	CTL	Control method		Selects the control method.	0001H	40002	42002	0: ONOF (ON/OFF control) 1: PID (PID control) 2: FUZY (Fuzzy control) 3: SELF (Self-tuning control) 4: Pid2 (PID2 control) 5: 2FRE (2-degrees-of-freedom PID)		Pid		
623	PRCS	Control target		Selects the control target.	01A7H	40424	42424	0: SRV1 (servo control 1) 1: SRV2 (servo control 2) 2: PFb (Position feedback control)		SrV1: without position feedback control PFb: with position feedback control		
624	oNoF	ONOFF hysteresis		Selects the hysteresis operation during 2-position control.	01A5H	40422	42422	0: oFF 1: oN		oN		
626	STMd	Start mode		Sets the operation mode during startup	01B1H	40434	42434	0: AUTO (starts in AUTO mode) 1: Man (starts in Manual mode) 2: rEM (starts in remote mode) 3: STBY (starts in Standby mode)		AUTO		
627	dT	Control operation cycle		Sets the control operation cycle.	01B2H	40435	42435	0-8: 0.1 to 0.9 s 9-107: 1 to 99 s		0.1s		
628	PLtS	PID switching method		Sets the method for switching among PID palettes.	00DEH	40223	42223	0: selected PID № 1: selected SV № 2: PV		0		

## Ch 8 MATH (calculation parameters)

No.	Display	Value		Function	Relative address	Register No.		Read data	Written data range	Factory-set value	Dependent on range	Remarks
		Name				Internal	Engineering unit					
650	MATh	Simple calculation ON/OFF		Sets ON/OFF of simple calculation	033E H	40831	42831	0: OFF 1: ON		OFF		
651	W1MA	Wafer 1 Calculation		Sets the wafer corresponds to the operating parameter	033F H	40832	42832	0: no operation 1: logical operation wafer 1 2: logical operation wafer 2 3: logical operation wafer 3 4: logical operation wafer 4 5: logical operation wafer 5 6: switching wafer		0		
652	W1i1	Wafer 1 Input 1		Sets the wafer input 1.	0340 H	40833	42833	0 to 9999		0		
653	W1i2	Wafer 1 Input 2		Sets the wafer input 2.	0341 H	40834	42834	0 to 9999		0		
654	W1i3	Wafer 1 Input 3		Sets the wafer input 3.	0342 H	40835	42835	0 to 9999		0		
659	W2MA	Wafer 2 Calculation		Sets the wafer corresponds to the operating parameter	0343 H	40836	42836	0 to 6		0		
660	W2i1	Wafer 2 Input 1		Sets the wafer input 1.	0344 H	40837	42837	0 to 9999		0		
661	W2i2	Wafer 2 Input 2		Sets the wafer input 2.	0345 H	40838	42838	0 to 9999		0		
662	W2i3	Wafer 2 Input 3		Sets the wafer input 3.	0346 H	40839	42839	0 to 9999		0		
667	W3MA	Wafer 3 Calculation		Sets the wafer corresponds to the operating parameter	0347 H	40840	42840	0 to 9999		0		
668	W3i1	Wafer 3 Input 1		Sets the wafer input 1.	0348 H	40841	42841	0 to 9999		0		
669	W3i2	Wafer 3 Input 2		Sets the wafer input 2.	0349 H	40842	42842	0 to 9999		0		
670	W3i3	Wafer 3 Input 3		Sets the wafer input 3.	034A H	40843	42843	0 to 9999		0		
675	W4MA	Wafer 4 Calculation		Sets the wafer corresponds to the operating parameter	034B H	40844	42844	0 to 9999		0		
676	W4i1	Wafer 4 Input 1		Sets the wafer input 1.	034C H	40845	42845	0 to 9999		0		
677	W4i2	Wafer 4 Input 2		Sets the wafer input 2.	034D H	40846	42846	0 to 9999		0		
678	W4i3	Wafer 4 Input 3		Sets the wafer input 3.	034E H	40847	42847	0 to 9999		0		
683	W5MA	Wafer 5 Calculation		Sets the wafer corresponds to the operating parameter	034F H	40848	42848	0 to 9999		0		
684	W5i1	Wafer 5 Input 1		Sets the wafer input 1.	0350 H	40849	42849	0 to 9999		0		
685	W5i2	Wafer 5 Input 2		Sets the wafer input 2.	0351 H	40850	42850	0 to 9999		0		
686	W5i3	Wafer 5 Input 3		Sets the wafer input 3.	0352 H	40851	42851	0 to 9999		0		
691	W6MA	Wafer 6 Calculation		Sets the wafer corresponds to the operating parameter	0353 H	40852	42852	0 to 9999		0		
692	W6i1	Wafer 6 Input 1		Sets the wafer input 1.	0354 H	40853	42853	0 to 9999		0		
693	W6i2	Wafer 6 Input 2		Sets the wafer input 2.	0355 H	40854	42854	0 to 9999		0		
694	W6i3	Wafer 6 Input 3		Sets the wafer input 3.	0356 H	40855	42855	0 to 9999		0		
699	W7MA	Wafer 7 Calculation		Sets the wafer corresponds to the operating parameter	0357 H	40856	42856	0 to 9999		0		
700	W7i1	Wafer 7 Input 1		Sets the wafer input 1.	0358 H	40857	42857	0 to 9999		0		
701	W7i2	Wafer 7 Input 2		Sets the wafer input 2.	0359 H	40858	42858	0 to 9999		0		
702	W7i3	Wafer 7 Input 3		Sets the wafer input 3.	035A H	40859	42859	0 to 9999		0		
707	W8MA	Wafer 8 Calculation		Sets the wafer corresponds to the operating parameter	035B H	40860	42860	0 to 9999		0		
708	W8i1	Wafer 8 Input 1		Sets the wafer input 1.	035C H	40861	42861	0 to 9999		0		
709	W8i2	Wafer 8 Input 2		Sets the wafer input 2.	035D H	40862	42862	0 to 9999		0		
710	W8i3	Wafer 8 Input 3		Sets the wafer input 3.	035E H	40863	42863	0 to 9999		0		
715	W9MA	Wafer 9 Calculation		Sets the wafer corresponds to the operating parameter	035F H	40864	42864	0 to 9999		0		
716	W9i1	Wafer 9 Input 1		Sets the wafer input 1.	0360 H	40865	42865	0 to 9999		0		
717	W9i2	Wafer 9 Input 2		Sets the wafer input 2.	0361 H	40866	42866	0 to 9999		0		
718	W9i3	Wafer 9 Input 3		Sets the wafer input 3.	0362 H	40867	42867	0 to 9999		0		
723	WAMA	Wafer 10 Calculation		Sets the wafer corresponds to the operating parameter	0363 H	40868	42868	0 to 9999		0		
724	WAI1	Wafer 10 Input 1		Sets the wafer input 1.	0364 H	40869	42869	0 to 9999		0		
725	WAI2	Wafer 10 Input 2		Sets the wafer input 2.	0365 H	40870	42870	0 to 9999		0		
726	WAI3	Wafer 10 Input 3		Sets the wafer input 3.	0366 H	40871	42871	0 to 9999		0		
731	CoN1	Constant 1		Sets the constant 1.	0367 H	40872	42872	-32768 to 32767		0		
732	CoN2	Constant 2		Sets the constant 2.	0368 H	40873	42873	-32768 to 32767		0		
733	CoN3	Constant 3		Sets the constant 3.	0369 H	40874	42874	-32768 to 32767		0		
734	CoN4	Constant 4		Sets the constant 4.	036A H	40875	42875	-32768 to 32767		0		
735	CoN5	Constant 5		Sets the constant 5.	036B H	40876	42876	-32768 to 32767		0		
736	CoN6	Constant 6		Sets the constant 6.	036C H	40877	42877	-32768 to 32767		0		
737	CoN7	Constant 7		Sets the constant 7.	036D H	40878	42878	-32768 to 32767		0		
738	CoN8	Constant 8		Sets the constant 8.	036E H	40879	42879	-32768 to 32767		0		
739	CoN9	Constant 9		Sets the constant 9.	036F H	40880	42880	-32768 to 32767		0		
740	CoNA	Constant 10		Sets the constant 10.	0370 H	40881	42881	-32768 to 32767		0		

## Ch 9 COM (communication parameters)

No.	Display	Value Name	Function	Relative address	Register No.		Read data	Written data range	Factory-set value	Dependent on range	Remarks
					Internal	Engineering unit					
760	CtYP	Communication type	Selects the type of communication.	0384 H	40901	42901	0: MODBUS RTU 1: Cooperative operation 2: Programless communication		0		[RESET]
761	STNo	Station No.	Sets the station number.	0385 H	40902	42902	0 to 255 (0: unresponsive communication)		1		[RESET]
762	SPED	RS-485 baud rate	Sets the baud rate	0386 H	40903	42903	0: 96 (9600 bps) 1: 192 (19200 bps) 2: 384 (38400 bps) 3: 115K (115 Kbps)		96		[RESET]
763	PrTy	RS-485 parity	Sets the parity check	0387 H	40904	42904	0: none 1: odd 2: even		odd		[RESET]
764	intv	RS-485 response interval	Widen the time interval of receiving response. (Set value x 20 ms)	0388 H	40905	42905	0 to 100		1 (20 ms)		[RESET]
765	RvWt	RS-485 receive timeout	Increases the waiting period for response. (Set value x 10 ms)	0389 H	40906	42906	1 to 100		1 (10 ms)		[RESET]
766	RvCt	RS-485 send retry times	Sets the number of send retry times. (Used in Cooperative operation or Programless communication)	038A H	40907	42907	0 to 10		3		[RESET]
767	SCC	Communication permissions	Sets whether or not overwriting is possible from the master side (PC, etc.)	038B H	40908	42908	0: r (Read only) 1: rW (Read and writable)		rW		[RESET]
768	MxSt	Max. station number	Sets the maximum station number for communication.	038C H	40909	42909	0 to 31 (0: undefined)		0		[RESET]
769	UA01	MODBUS user address setting 1	Sets the MODBUS user address. The communication address is 45001.	038D H	40910	42910	30001 to 49999		30001		[RESET]
770	UA02	MODBUS user address setting 2	Sets the MODBUS user address. The communication address is 45002.	038E H	40911	42911	30001 to 49999		30001		[RESET]
771	UA03	MODBUS user address setting 3	Sets the MODBUS user address. The communication address is 45003.	038F H	40912	42912	30001 to 49999		30001		[RESET]
772	UA04	MODBUS user address setting 4	Sets the MODBUS user address. The communication address is 45004.	0390 H	40913	42913	30001 to 49999		30001		[RESET]
773	UA05	MODBUS user address setting 5	Sets the MODBUS user address. The communication address is 45005.	0391 H	40914	42914	30001 to 49999		30001		[RESET]
774	UA06	MODBUS user address setting 6	Sets the MODBUS user address. The communication address is 45006.	0392 H	40915	42915	30001 to 49999		30001		[RESET]
775	UA07	MODBUS user address setting 7	Sets the MODBUS user address. The communication address is 45007.	0393 H	40916	42916	30001 to 49999		30001		[RESET]
776	UA08	MODBUS user address setting 8	Sets the MODBUS user address. The communication address is 45008.	0394 H	40917	42917	30001 to 49999		30001		[RESET]
777	UA09	MODBUS user address setting 9	Sets the MODBUS user address. The communication address is 45009.	0395 H	40918	42918	30001 to 49999		30001		[RESET]
778	UA10	MODBUS user address setting 10	Sets the MODBUS user address. The communication address is 45010.	0396 H	40919	42919	30001 to 49999		30001		[RESET]
779	UA11	MODBUS user address setting 11	Sets the MODBUS user address. The communication address is 45011.	0397 H	40920	42920	30001 to 49999		30001		[RESET]
780	UA12	MODBUS user address setting 12	Sets the MODBUS user address. The communication address is 45012.	0398 H	40921	42921	30001 to 49999		30001		[RESET]
781	UA13	MODBUS user address setting 13	Sets the MODBUS user address. The communication address is 45013.	0399 H	40922	42922	30001 to 49999		30001		[RESET]
782	UA14	MODBUS user address setting 14	Sets the MODBUS user address. The communication address is 45014.	039A H	40923	42923	30001 to 49999		30001		[RESET]
783	UA15	MODBUS user address setting 15	Sets the MODBUS user address. The communication address is 45015.	039B H	40924	42924	30001 to 49999		30001		[RESET]
784	UA16	MODBUS user address setting 16	Sets the MODBUS user address. The communication address is 45016.	039C H	40925	42925	30001 to 49999		30001		[RESET]
785	UA17	MODBUS user address setting 17	Sets the MODBUS user address. The communication address is 45017.	039D H	40926	42926	30001 to 49999		30001		[RESET]
786	UA18	MODBUS user address setting 18	Sets the MODBUS user address. The communication address is 45018.	039E H	40927	42927	30001 to 49999		30001		[RESET]
787	UA19	MODBUS user address setting 19	Sets the MODBUS user address. The communication address is 45019.	039F H	40928	42928	30001 to 49999		30001		[RESET]
788	UA20	MODBUS user address setting 20	Sets the MODBUS user address. The communication address is 45020.	03A0 H	40929	42929	30001 to 49999		30001		[RESET]
789	UA21	MODBUS user address setting 21	Sets the MODBUS user address. The communication address is 45021.	03A1 H	40930	42930	30001 to 49999		30001		[RESET]
790	UA22	MODBUS user address setting 22	Sets the MODBUS user address. The communication address is 45022.	03A2 H	40931	42931	30001 to 49999		30001		[RESET]
791	UA23	MODBUS user address setting 23	Sets the MODBUS user address. The communication address is 45023.	03A3 H	40932	42932	30001 to 49999		30001		[RESET]
792	UA24	MODBUS user address setting 24	Sets the MODBUS user address. The communication address is 45024.	03A4 H	40933	42933	30001 to 49999		30001		[RESET]
793	UA25	MODBUS user address setting 25	Sets the MODBUS user address. The communication address is 45025.	03A5 H	40934	42934	30001 to 49999		30001		[RESET]
794	UA26	MODBUS user address setting 26	Sets the MODBUS user address. The communication address is 45026.	03A6 H	40935	42935	30001 to 49999		30001		[RESET]
795	UA27	MODBUS user address setting 27	Sets the MODBUS user address. The communication address is 45027.	03A7 H	40936	42936	30001 to 49999		30001		[RESET]
796	UA28	MODBUS user address setting 28	Sets the MODBUS user address. The communication address is 45028.	03A8 H	40937	42937	30001 to 49999		30001		[RESET]
797	UA29	MODBUS user address setting 29	Sets the MODBUS user address. The communication address is 45029.	03A9 H	40938	42938	30001 to 49999		30001		[RESET]
798	UA30	MODBUS user address setting 30	Sets the MODBUS user address. The communication address is 45030.	03AA H	40939	42939	30001 to 49999		30001		[RESET]
799	UA31	MODBUS user address setting 31	Sets the MODBUS user address. The communication address is 45031.	03AB H	40940	42940	30001 to 49999		30001		[RESET]

No.	Display	Value	Function	Relative address	Register No.		Read data	Written data range	Factory-set value	Dependent on range	Remarks
		Name			Internal	Engineering unit					
800	UA32	MODBUS user address setting 32	Sets the MODBUS user address. The communication address is 45032.	03AC H	40941	42941	30001 to 49999		30001		[RESET]
801	CSVG	Communication SV gain	Configures the gain to be added to SV changed through cooperative operation.	03ADH	40942	42942	1 to 9999 (0.001 to 9.999)		1.000		
802	CSVS	Communication SV shift	Sets the shift value for SV changed through cooperative operation.	03AEH	40943	42943	-100 to 100%FS		0%FS		
803	kykd	Cooperative operation items	Selects the items to be changed through cooperative operation.	03D5 H	40982	42982	0: SV and RUN/standby 1: all parameters		0		[RESET]
804	APCy	All parameters copy	Copies all parameter values of a master to slave devices.	03AFH	40944	42944	0: not copy 1: copy		0		
805	PLSt	Target PLC station No.	Sets the target station number for programless communication.	03B0H	40945	42945	0 to 255 (0: undefined)		0		[RESET]
806	PAdk	PLC registration number allocation rule	Define the method for allocating registration numbers to the PLC programless communication areas.	03B1H	40946	42946	0: contiguous allocation 1: individual allocation		0		[RESET]
807	MSWt	Communication interval between temperature controllers	Sets the time interval of programless communications between temperature controllers	03B2H	40947	42947	0 - 100 (0 to 100 ms)		20 ms		[RESET]
808	PLWt	Communication interval between a PLC and temperature controllers	Sets the time interval of programless communications between a PLC and temperature controllers (setpoint x 2 ms).	03B3H	40948	42948	0 - 100 (0 to 200 ms)		20 ms		[RESET]
809	PLAd	Head of PLC registration numbers	Sets the PLC register number to which PXF accesses in programless communication.	03B4H	40949	42949	0000 - FFFFF		0		[RESET]
810	SA01	Modbus address of data No.1 in setting area	Sets a MODBUS address for data to be registered in setting area data field in programless communication	03B5H	40950	42950	0 - 49999 (0: undefined, 40001 to 49999: MODBUS address)		0		[RESET]
811	SA02	Modbus address of data No.2 in setting area	Sets a MODBUS address for data to be registered in setting area data field in programless communication	03B6H	40951	42951	0 - 49999 (0: undefined, 40001 to 49999: MODBUS address)		0		[RESET]
812	SA03	Modbus address of data No.3 in setting area	Sets a MODBUS address for data to be registered in setting area data field in programless communication	03B7H	40952	42952	0 - 49999 (0: undefined, 40001 to 49999: MODBUS address)		0		[RESET]
813	SA04	Modbus address of data No.4 in setting area	Sets a MODBUS address for data to be registered in setting area data field in programless communication	03B8H	40953	42953	0 - 49999 (0: undefined, 40001 to 49999: MODBUS address)		0		[RESET]
814	SA05	Modbus address of data No.5 in setting area	Sets a MODBUS address for data to be registered in setting area data field in programless communication	03B9H	40954	42954	0 - 49999 (0: undefined, 40001 to 49999: MODBUS address)		0		[RESET]
815	SA06	Modbus address of data No.6 in setting area	Sets a MODBUS address for data to be registered in setting area data field in programless communication	03BAH	40955	42955	0 - 49999 (0: undefined, 40001 to 49999: MODBUS address)		0		[RESET]
816	SA07	Modbus address of data No.7 in setting area	Sets a MODBUS address for data to be registered in setting area data field in programless communication	03BBH	40956	42956	0 - 49999 (0: undefined, 40001 to 49999: MODBUS address)		0		[RESET]
817	SA08	Modbus address of data No.8 in setting area	Sets a MODBUS address for data to be registered in setting area data field in programless communication	03BCH	40957	42957	0 - 49999 (0: undefined, 40001 to 49999: MODBUS address)		0		[RESET]
818	SA09	Modbus address of data No.9 in setting area	Sets a MODBUS address for data to be registered in setting area data field in programless communication	03BDH	40958	42958	0 - 49999 (0: undefined, 40001 to 49999: MODBUS address)		0		[RESET]
819	SA10	Modbus address of data No.10 in setting area	Sets a MODBUS address for data to be registered in setting area data field in programless communication	03BEH	40959	42959	0 - 49999 (0: undefined, 40001 to 49999: MODBUS address)		0		[RESET]
820	SA11	Modbus address of data No.11 in setting area	Sets a MODBUS address for data to be registered in setting area data field in programless communication	03BFH	40960	42960	0 - 49999 (0: undefined, 40001 to 49999: MODBUS address)		0		[RESET]
821	SA12	Modbus address of data No.12 in setting area	Sets a MODBUS address for data to be registered in setting area data field in programless communication	03C0H	40961	42961	0 - 49999 (0: undefined, 40001 to 49999: MODBUS address)		0		[RESET]
822	SA13	Modbus address of data No.13 in setting area	Sets a MODBUS address for data to be registered in setting area data field in programless communication	03C1H	40962	42962	0 - 49999 (0: undefined, 40001 to 49999: MODBUS address)		0		[RESET]
823	SA14	Modbus address of data No.14 in setting area	Sets a MODBUS address for data to be registered in setting area data field in programless communication	03C2H	40963	42963	0 - 49999 (0: undefined, 40001 to 49999: MODBUS address)		0		[RESET]
824	SA15	Modbus address of data No.15 in setting area	Sets a MODBUS address for data to be registered in setting area data field in programless communication	03C3H	40964	42964	0 - 49999 (0: undefined, 40001 to 49999: MODBUS address)		0		[RESET]
825	SA16	Modbus address of data No.16 in setting area	Sets a MODBUS address for data to be registered in setting area data field in programless communication	03C4H	40965	42965	0 - 49999 (0: undefined, 40001 to 49999: MODBUS address)		0		[RESET]
826	MA01	Modbus address of data No.1 in monitor area	Sets a MODBUS address for data to be registered in monitor area data field in programless communication.	03C5H	40966	42966	0 - 49999 (0: undefined, 30001 to 39999, 40001 to 49999: MODBUS address)		0		[RESET]
827	MA02	Modbus address of data No.2 in monitor area	Sets a MODBUS address for data to be registered in monitor area data field in programless communication.	03C6H	40967	42967	0 - 49999 (0: undefined, 30001 to 39999, 40001 to 49999: MODBUS address)		0		[RESET]
828	MA03	Modbus address of data No.3 in monitor area	Sets a MODBUS address for data to be registered in monitor area data field in programless communication.	03C7H	40968	42968	0 - 49999 (0: undefined, 30001 to 39999, 40001 to 49999: MODBUS address)		0		[RESET]
829	MA04	Modbus address of data No.4 in monitor area	Sets a MODBUS address for data to be registered in monitor area data field in programless communication.	03C8H	40969	42969	0 - 49999 (0: undefined, 30001 to 39999, 40001 to 49999: MODBUS address)		0		[RESET]
830	MA05	Modbus address of data No.5 in monitor area	Sets a MODBUS address for data to be registered in monitor area data field in programless communication.	03C9H	40970	42970	0 - 49999 (0: undefined, 30001 to 39999, 40001 to 49999: MODBUS address)		0		[RESET]

Value			Function	Relative address	Register No.		Read data	Written data range	Factory-set value	Dependent on range	Remarks
No.	Display	Name			Internal	Engineering unit					
831	MA06	Modbus address of data No.6 in monitor area	Sets a MODBUS address for data to be registered in monitor area data field in programless communication.	03CAH	40971	42971	0 - 49999 (0: undefined, 30001 to 39999, 40001 to 49999: MODBUS address)	0		[RESET]	
832	MA07	Modbus address of data No.7 in monitor area	Sets a MODBUS address for data to be registered in monitor area data field in programless communication.	03CBH	40972	42972	0 - 49999 (0: undefined, 30001 to 39999, 40001 to 49999: MODBUS address)	0		[RESET]	
833	MA08	Modbus address of data No.8 in monitor area	Sets a MODBUS address for data to be registered in monitor area data field in programless communication.	03CCH	40973	42973	0 - 49999 (0: undefined, 30001 to 39999, 40001 to 49999: MODBUS address)	0		[RESET]	
834	MA09	Modbus address of data No.9 in monitor area	Sets a MODBUS address for data to be registered in monitor area data field in programless communication.	03CDH	40974	42974	0 - 49999 (0: undefined, 30001 to 39999, 40001 to 49999: MODBUS address)	0		[RESET]	
835	MA10	Modbus address of data No.10 in monitor area	Sets a MODBUS address for data to be registered in monitor area data field in programless communication.	03CEH	40975	42975	0 - 49999 (0: undefined, 30001 to 39999, 40001 to 49999: MODBUS address)	0		[RESET]	
836	MA11	Modbus address of data No.11 in monitor area	Sets a MODBUS address for data to be registered in monitor area data field in programless communication.	03CFH	40976	42976	0 - 49999 (0: undefined, 30001 to 39999, 40001 to 49999: MODBUS address)	0		[RESET]	
837	MA12	Modbus address of data No.12 in monitor area	Sets a MODBUS address for data to be registered in monitor area data field in programless communication.	03D0H	40977	42977	0 - 49999 (0: undefined, 30001 to 39999, 40001 to 49999: MODBUS address)	0		[RESET]	
838	MA13	Modbus address of data No.13 in monitor area	Sets a MODBUS address for data to be registered in monitor area data field in programless communication.	03D1H	40978	42978	0 - 49999 (0: undefined, 30001 to 39999, 40001 to 49999: MODBUS address)	0		[RESET]	
839	MA14	Modbus address of data No.14 in monitor area	Sets a MODBUS address for data to be registered in monitor area data field in programless communication.	03D2H	40979	42979	0 - 49999 (0: undefined, 30001 to 39999, 40001 to 49999: MODBUS address)	0		[RESET]	
840	MA15	Modbus address of data No.15 in monitor area	Sets a MODBUS address for data to be registered in monitor area data field in programless communication.	03D3H	40980	42980	0 - 49999 (0: undefined, 30001 to 39999, 40001 to 49999: MODBUS address)	0		[RESET]	
841	MA16	Modbus address of data No.16 in monitor area	Sets a MODBUS address for data to be registered in monitor area data field in programless communication.	03D4H	40981	42981	0 - 49999 (0: undefined, 30001 to 39999, 40001 to 49999: MODBUS address)	0		[RESET]	

### Ch10 PFB (PFB parameters)

Value			Function	Relative address	Register No.		Read data	Written data range	Factory-set value	Dependent on range	Remarks
No.	Display	Name			Internal	Engineering unit					
870	PGAP	PFB dead band	Selects the type of communication.	01A8 H	40425	42425	0 - 10000 (0.0 to 100.0%)	0			
871	TRVL	Valve stroke time	Sets the full stroke time of the valve.	01A9 H	40426	42426	5 - 180 (5 to 180 s)	30 s			
873	CAL	PFB input adjustment	Carry out zero/span adjustment of PFB input.	01AB H	40428	42428	0: no adjustment/forced termination 1: zero adjustment 2: span adjustment 3: auto adjustment	0			

## Ch 11 DSP (parameter mask)

No.	Display	Value		Function	Relative address	Register No.		Read data	Written data range	Factory-set value	Dependent on range	Remarks
		Name				Internal	Engineering unit					
-dP01		Parameter mask		Sets the parameters to be displayed/not displayed.	01C2H	40451	42451	0000 to FFFFh		Value differs depending on the model.		
-dP02			01C3H		40452	42452	0000 to FFFFh					
-dP03			01C4H		40453	42453	0000 to FFFFh					
-dP04			01C5H		40454	42454	0000 to FFFFh					
-dP05			01C6H		40455	42455	0000 to FFFFh					
-dP06			01C7H		40456	42456	0000 to FFFFh					
-dP07			01C8H		40457	42457	0000 to FFFFh					
-dP08			01C9H		40458	42458	0000 to FFFFh					
-dP09			01CAH		40459	42459	0000 to FFFFh					
-dP10			01CBH		40460	42460	0000 to FFFFh					
-dP11			01CCH		40461	42461	0000 to FFFFh					
-dP12			01CDH		40462	42462	0000 to FFFFh					
-dP13			01CEH		40463	42463	0000 to FFFFh					
-dP14			01CFH		40464	42464	0000 to FFFFh					
-dP15			01D0H		40465	42465	0000 to FFFFh					
-dP16			01D1H		40466	42466	0000 to FFFFh					
-dP17			01D2H		40467	42467	0000 to FFFFh					
-dP18			01D3H		40468	42468	0000 to FFFFh					
-dP19			01D4H		40469	42469	0000 to FFFFh					
-dP20			01D5H		40470	42470	0000 to FFFFh					
-dP21			01D6H		40471	42471	0000 to FFFFh					
-dP22			01D7H		40472	42472	0000 to FFFFh					
-dP23			01D8H		40473	42473	0000 to FFFFh					
-dP24			01D9H		40474	42474	0000 to FFFFh					
-dP25			01DAH		40475	42475	0000 to FFFFh					
-dP26			01DBH		40476	42476	0000 to FFFFh					
-dP27			01DCH		40477	42477	0000 to FFFFh					
-dP28			01DDH		40478	42478	0000 to FFFFh					
-dP29			01DEH		40479	42479	0000 to FFFFh					
-dP30			01DFH		40480	42480	0000 to FFFFh					
-dP31			01E0H		40481	42481	0000 to FFFFh					

## Ch12 CFG (configuration parameters)

No.	Display	Value		Function	Relative address	Register No.		Read data	Written data range	Factory-set value	Dependent on range	Remarks
		Name				Internal	Engineering unit					
940	ToUT	Operation timeout (return to PV/SV display)		Sets the time until the display returns to PV/SV screen from setting screen.	0212 H	40531	42531	0: 15S (15sec) 1: 30S (30sec) 2: 60S (60sec) 3: 5M (5min) 4: 10M (10min) 5: non (auto-return OFF)		60S		
942	SoFk	Blinking SV during Soft Start		Sets whether or not to blink SV during Soft Start.	0215 H	40534	42534	0: oFF 1: oN		ON		
943	ALMF	Blinking PV/SV at ALM		Sets whether or not to blink PV/SV when DO becomes ON.	0216 H	40535	42535	0: PV display (no change) 1: PV and alarm status, alternately 2: blinking PV 3: alarm status		0		
944	LOFF	Display timeout		Sets the time until the display automatically turns off.	0213 H	40532	42532	1: oFF (Not use) 2: 15s (Auto-off after 15 sec.) 3: 30s (Auto-off after 30 sec.) 4: 1M (Auto-off after 1 min.) 5: 5M (Auto off after 5 min.)		oFF		
945	DSPT	PV/SV Display off		Sets ON/OFF of PV and SV display	0219 H	40538	42538	0: PV and SV ON 1: SV OFF 2: PV OFF 3: PV and SV OFF 4: PV, SV, and indicators OFF (all OFF) 5: SV OFF (relights for 5 sec. by pressing any key) 6: PV OFF (relights for 5 sec. by pressing any key) 7: PV and SV OFF (relights for 5 sec. by pressing any key) 8: PV, SV, and indicators OFF (relights for 5 sec. by pressing any key)		0		
946	FLTF	Blinking PV at input error		Sets whether or not to blink PV at an input error	021A H	40539	42539	0: PV blinks at an input error 1: No blink		0		
947	BLIT	Brightness		Sets the brightness of LED backlight	021B H	40540	42540	0 to 3 (3 is the brightest)		3		
948	bCon	Control at burnout		Sets whether to continue or to stop control when the device detects a burnout of PV input	0218 H	40537	42537	0: oFF (stops control) 1: oN (continues control)		OFF		



## Ch 13 PASS (password parameters)

No.	Display	Value		Function	Relative address	Register No.		Read data	Written data range	Factory-set value	Dependent on range	Remarks
		Name				Internal	Engineering unit					
990	PAS1	Password1 setup		Sets password 1.	0209 H	40522	42522	0000 to FFFF		0000		
991	PAS2	Password2 setup		Sets password 2.	020A H	40523	42523	0000 to FFFF		0000		
992	PAS3	Password3 setup		Sets password 3.	020B H	40524	42524	0000 to FFFF		0000		

## Others

No.	Display	Value		Function	Relative address	Register No.		Read data	Written data range	Factory-set value	Dependent on range	Remarks
		Name				Internal	Engineering unit					
-	SV	Front SV		Sets SV on front panel.	0002 H	40003	42003	0 to 100%FS		0.00%FS	○	
-	MV	Front MV		Sets MV on front panel during manual mode.	0079 H	40122	42122	-500 to 10500 (-5.0 to 105.0%)		0000		

## Resistor Number Order Read/Write Parameter List

Relative address	Register No.		Name	Contents
	Internal	Engineering unit		
0000H	40001	42001	-	-
0001H	40002	42002	CTrL	Control method
0002H	40003	42003	SV	Front SV
0003H	40004	42004	STby	Switchover between RUN and standby
0004H	40005	42005	AT	Auto-tuning run command
0005H	40006	42006	P	Proportional band
0006H	40007	42007	i	Integration time
0007H	40008	42008	d	Differential time
0008H	40009	42009	hYS	ON/OFF control hysteresis
0009H	40010	42010	CoL	Cooling proportional band coefficient
000AH	40011	42011	db	Dead band
000BH	40012	42012	Ar	Anti-reset windup
000CH	40013	42013	bAL	Output convergence value
000DH	40014	42014	PvoF	PV input shift
000EH	40015	42015	SvoF	SV shift
000FH	40016	42016	PvT	PV Input type
0010H	40017	42017	PvU	Unit
0011H	40018	42018	Pvb	PV input lower limit
0012H	40019	42019	PvF	PV input upper limit
0013H	40020	42020	Pvd	Decimal point position
0014H	40021	42021	-	-
0015H	40022	42022	TF	PV input filter
0016H	40023	42023	rCJ	Cold junction compensation
0017H	40024	42024	PCUT	Type of output limiter
0018H	40025	42025	PLC1	OUT1 lower limit
0019H	40026	42026	PhC1	OUT1 upper limit
001AH	40027	42027	PLC2	OUT2 lower limit
001BH	40028	42028	PhC2	OUT2 upper limit
001EH	40031	42031	SvL	SV lower limit
001FH	40032	42032	SvH	SV upper limit
0026H	40039	42039	hb1	HB alarm set value
0027H	40040	42040	LoC	Key lock
0028H	40041	42041	AM1T	AM1 output event type
0029H	40042	42042	AM2T	AM2 output event type
002AH	40043	42043	AM3T	AM3 output event type
002BH	40044	42044	AL1	ALM1 set value or A1-L set value
002CH	40045	42045	AL2	ALM2 set value or A2-L set value
002DH	40046	42046	AL3	ALM3 set value or A3-L set value
002EH	40047	42047	A1-h	Alarm 1 upper limit set value
002FH	40048	42048	A2-h	Alarm 2 upper limit set value
0030H	40049	42049	A3-h	Alarm 3 upper limit set value
0031H	40050	42050	A1hY	ALM1 hysteresis
0032H	40051	42051	A2hY	ALM2 hysteresis
0033H	40052	42052	A3hY	ALM3 hysteresis
0034H	40053	42053	dLY1	ALM1 delay
0035H	40054	42054	dLY2	ALM2 delay
0036H	40055	42055	dLY3	ALM3 delay
0050H	40081	42081	Mod	Ramp soak mode
0051H	40082	42082	PrG	Ramp soak control command
0052H	40083	42083	PTn	Ramp soak operation pattern
0054H	40085	42085	SLFb	PV stable width during self-tuning
0056H	40087	42087	COMDI	Communication DI
0057H	40088	42088	rEv	normal/reverse operation
0058H	40089	42089	TC1	OUT1 proportion cycle
0059H	40090	42090	TC2	OUT2 proportion cycle
005BH	40092	42092	doP1	DO1 option
005CH	40093	42093	doP2	DO2 option
005DH	40094	42094	doP3	DO3 option
005EH	40095	42095	di1	Di-1 function
005FH	40096	42096	di2	Di-2 function
0060H	40097	42097	onoF	ON/OFF hysteresis mode
0062H	40099	42099	AdJ0	PV display zero adjustment
0063H	40100	42100	AdJS	PV display span adjustment
0071H	40114	42114	Aot	AO output type
0072H	40115	42115	AoL	AO lower scaling
0073H	40116	42116	AoH	AO upper scaling
0074H	40117	42117	REM	Local/remote switchover
0075H	40118	42118	REMO	RSV zero adjustment
0076H	40119	42119	REMS	RSV span adjustment
0077H	40120	42120	RiF	RSV input filter
0078H	40121	42121	MAn	Switchover between auto and manual mode
0079H	40122	42122	MV	Front MV
0082H	40131	42131	SV	Front SV
0083H	40132	42132	MV	Front MV
0084H	40133	42133	MAn	Switchover between auto and manual mode
0085H	40134	42134	STby	Switchover between RUN and standby
0086H	40135	42135	AT	Auto-tuning run command
0087H	40136	42136	rEM	switching remote mode
008AH	40139	42139	Uky1	key assignment (USER 1)
008BH	40140	42140	Uky2	key assignment (USER 2)
008CH	40141	42141	Uky3	key assignment (USER 3)

Relative address	Register No.		Name	Contents
	Internal	Engineering unit		
008EH	40143	42143	di1	Di-1 function
008FH	40144	42144	di2	Di-2 function
0090H	40145	42145	di3	Di-3 function
0091H	40146	42146	di4	Di-4 function
0092H	40147	42147	di5	Di-5 function
00A0H	40161	42161	LACh	DO output latch release command
00A1H	40162	42162	A1TP	ALM1 alarm type
00A2H	40163	42163	AL1	ALM1 set value or A1-L set value
00A3H	40164	42164	A1-h	Alarm 1 upper limit set value
00A4H	40165	42165	A1hY	ALM1 hysteresis
00A5H	40166	42166	AoP1	ALM1 option
00A6H	40167	42167	dLY1	ALM1 delay
00A7H	40168	42168	d1U	ALM1 delay time unit
00A8H	40169	42169	A2TP	ALM2 alarm type
00A9H	40170	42170	AL2	ALM2 set value or A2-L set value
00AAH	40171	42171	A2-h	Alarm 2 upper limit set value
00ABH	40172	42172	A2hY	ALM2 hysteresis
00ACH	40173	42173	AoP2	ALM2 option
00ADH	40174	42174	dLY2	ALM2 delay
00AEH	40175	42175	dL2U	ALM2 delay time unit
00AFH	40176	42176	A3TP	ALM3 alarm type
00B0H	40177	42177	AL3	ALM3 set value or A3-L set value
00B1H	40178	42178	A3-h	Alarm 3 upper limit set value
00B2H	40179	42179	A3hY	ALM3 hysteresis
00B3H	40180	42180	AoP3	ALM3 option
00B4H	40181	42181	dLY3	ALM3 delay
00B5H	40182	42182	dL3U	ALM3 delay time unit
00B6H	40183	42183	AM4T	ALM4 alarm type
00B7H	40184	42184	AL4	ALM4 set value or A4-L set value
00B8H	40185	42185	A4-h	Alarm 4 upper limit set value
00B9H	40186	42186	A4hY	ALM4 hysteresis
00BAH	40187	42187	AoP4	ALM4 option
00BBH	40188	42188	dLY4	ALM4 delay
00BCH	40189	42189	dL4U	ALM4 delay time unit
00BDH	40190	42190	AM5T	ALM5 alarm type
00BEH	40191	42191	AL5	ALM5 set value or A5-L set value
00BFH	40192	42192	A5-h	Alarm 5 upper limit set value
00C0H	40193	42193	A5hY	ALM5 hysteresis
00C1H	40194	42194	AoP5	ALM5 option
00C2H	40195	42195	dLY5	ALM5 delay
00C3H	40196	42196	dL5U	ALM5 delay time unit
00CBH	40204	42204	hb1	HB alarm 1 set value
00CCH	40205	42205	hb1h	HB alarm 1 hysteresis
00CDH	40206	42206	hS1	Shorted-load alarm 1 set value
00CEH	40207	42207	hS1h	Shorted-load alarm 1 hysteresis
00D3H	40212	42212	LbTM	Loop break detection time
00D4H	40213	42213	LbAb	Loop break detection band
00D6H	40215	42215	WhAL	Electricity alarm
00DCH	40221	42221	SVn	SV selection
00DDH	40222	42222	PLn1	PID selection
00DEH	40223	42223	PLiS	PID switching method
00DFH	40224	42224	SvMX	Max SV selection number
00E0H	40225	42225	PL1M	Max PID selection number
00E6H	40231	42231	SV	Front SV
00E7H	40232	42232	P	Proportional band
00E8H	40233	42233	i	Integration time
00E9H	40234	42234	d	Differential time
00EAH	40235	42235	hYS	ON/OFF control hysteresis
00EBH	40236	42236	CoL	Cooling proportional band coefficient
00ECH	40237	42237	db	Dead band
00EDH	40238	42238	bAL	Output convergence value
00EEH	40239	42239	Ar	Anti-reset windup
00EFH	40240	42240	rEv	normal/reverse operation
00F0H	40241	42241	Sv1	Set value 1
00F1H	40242	42242	P1	Proportional band
00F2H	40243	42243	i1	Integration time
00F3H	40244	42244	d1	Differential time
00F4H	40245	42245	hYS1	ON/OFF control hysteresis
00F5H	40246	42246	CoL1	Cooling proportional band coefficient
00F6H	40247	42247	db1	Dead band
00F7H	40248	42248	bAL1	Output convergence value
00F8H	40249	42249	Ar1	Anti-reset windup
00F9H	40250	42250	rEv1	normal/reverse operation
00FAH	40251	42251	Sv2	Set value 2
00FBH	40252	42252	P2	Proportional band
00FCH	40253	42253	i2	Integration time
00FDH	40254	42254	d2	Differential time
00FEH	40255	42255	hYS2	ON/OFF control hysteresis
00FFH	40256	42256	CoL2	Cooling proportional band coefficient
0100H	40257	42257	db2	Dead band
0101H	40258	42258	bAL2	Output convergence value

Relative address	Register No.		Name	Contents
	Internal	Engineering unit		
0102H	40259	42259	Ar2	Anti-reset windup
0103H	40260	42260	rEV2	normal/reverse operation
0104H	40261	42261	Sv3	Set value 3
0105H	40262	42262	P3	Proportional band
0106H	40263	42263	i3	Integration time
0107H	40264	42264	d3	Differential time
0108H	40265	42265	hYS3	ON/OFF control hysteresis
0109H	40266	42266	CoL3	Cooling proportional band coefficient
010AH	40267	42267	db3	Dead band
010BH	40268	42268	bAL3	Output convergence value
010CH	40269	42269	Ar3	Anti-reset windup
010DH	40270	42270	rEV3	normal/reverse operation
010EH	40271	42271	Sv4	Set value 4
010FH	40272	42272	P4	Proportional band
0110H	40273	42273	i4	Integration time
0111H	40274	42274	d4	Differential time
0112H	40275	42275	hYS4	ON/OFF control hysteresis
0113H	40276	42276	CoL4	Cooling proportional band coefficient
0114H	40277	42277	db4	Dead band
0115H	40278	42278	bAL4	Output convergence value
0116H	40279	42279	Ar4	Anti-reset windup
0117H	40280	42280	rEV4	normal/reverse operation
0118H	40281	42281	Sv5	Set value 5
0119H	40282	42282	P5	Proportional band
011AH	40283	42283	i5	Integration time
011BH	40284	42284	d5	Differential time
011CH	40285	42285	hYS5	ON/OFF control hysteresis
011DH	40286	42286	CoL5	Cooling proportional band coefficient
011EH	40287	42287	db5	Dead band
011FH	40288	42288	bAL5	Output convergence value
0120H	40289	42289	Ar5	Anti-reset windup
0121H	40290	42290	rEV5	normal/reverse operation
0122H	40291	42291	Sv6	Set value 6
0123H	40292	42292	P6	Proportional band
0124H	40293	42293	i6	Integration time
0125H	40294	42294	d6	Differential time
0126H	40295	42295	hYS6	ON/OFF control hysteresis
0127H	40296	42296	CoL6	Cooling proportional band coefficient
0128H	40297	42297	db6	Dead band
0129H	40298	42298	bAL6	Output convergence value
012AH	40299	42299	Ar6	Anti-reset windup
012BH	40300	42300	rEV6	normal/reverse operation
012CH	40301	42301	Sv7	Set value 7
012DH	40302	42302	P7	Proportional band
012EH	40303	42303	i7	Integration time
012FH	40304	42304	d7	Differential time
0130H	40305	42305	hYS7	ON/OFF control hysteresis
0131H	40306	42306	CoL7	Cooling proportional band coefficient
0132H	40307	42307	db7	Dead band
0133H	40308	42308	bAL7	Output convergence value
0134H	40309	42309	Ar7	Anti-reset windup
0135H	40310	42310	rEV7	normal/reverse operation
0136H	40311	42311	REF1	PID Palette switching point 1 (PV)
0137H	40312	42312	REF2	PID Palette switching point 2 (PV)
0138H	40313	42313	REF3	PID Palette switching point 3 (PV)
0139H	40314	42314	REF4	PID Palette switching point 4 (PV)
013AH	40315	42315	REF5	PID Palette switching point 5 (PV)
013BH	40316	42316	REF6	PID Palette switching point 6 (PV)
013CH	40317	42317	REF7	PID Palette switching point 7 (PV)
0154H	40341	42341	PvT	PV Input type
0155H	40342	42342	Pvb	PV input lower limit
0156H	40343	42343	PvF	PV input upper limit
0157H	40344	42344	Pvd	Decimal point position
0158H	40345	42345	PvU	Unit
0159H	40346	42346	ROOT CUT	Square-root extractor cut point
015AH	40347	42347	PvoF	PV input shift
015BH	40348	42348	SvoF	SV input shift
015CH	40349	42349	SvL	SV lower limit
015DH	40350	42350	SvH	SV upper limit
015EH	40351	42351	TF	PV input filter
015FH	40352	42352	AdJ0	PV display zero adjustment
0160H	40353	42353	AdJS	PV display span adjustment
0161H	40354	42354	rCJ	Cold junction compensation
0162H	40355	42355	REM	Local/remote switchover
0163H	40356	42356	REMO	RSV zero adjustment
0164H	40357	42357	REMS	RSV span adjustment
0165H	40358	42358	REMR	RSV input range
0166H	40359	42359	RtF	RSV input filter
017CH	40381	42381	C1r	OUT1 range
017DH	40382	42382	C2r	OUT2 range
017EH	40383	42383	TC1	OUT1 proportion cycle
017FH	40384	42384	TC2	OUT2 proportion cycle
0180H	40385	42385	PLC1	OUT1 lower limit

Relative address	Register No.		Name	Contents
	Internal	Engineering unit		
0181H	40386	42386	PhC1	OUT1 upper limit
0182H	40387	42387	PLC2	OUT2 lower limit
0183H	40388	42388	PhC2	OUT2 upper limit
0184H	40389	42389	PCUT	Type of output limiter
0185H	40390	42390	FLo1	MV1 during FALT
0186H	40391	42391	FLo2	MV2 during FALT
0187H	40392	42392	SFo1	MV1 during soft start
0189H	40394	42394	SFTM	Soft start set time
018DH	40398	42398	Sbo1	MV1 during standby
018EH	40399	42399	Sbo2	MV2 during standby
018FH	40400	42400	SbMd	Standby mode
0190H	40401	42401	Aot	AO output type
0191H	40402	42402	AoL	AO lower scaling
0192H	40403	42403	AoH	AO upper scaling
0193H	40404	42404	OUT1T	OUT1 output type
0194H	40405	42405	OUT2T	OUT2 output type
0195H	40406	42406	do1T	DO1 output type
0196H	40407	42407	do2T	DO2 output type
0197H	40408	42408	do3T	DO3 output type
0198H	40409	42409	do4T	DO4 output type
0199H	40410	42410	do5T	DO5 output type
01A4H	40421	42421	CTrL	Control method
01A5H	40422	42422	onoF	ON/OFF hysteresis mode
01A6H	40423	42423	SLFb	PV stable width during self-tuning
01A7H	40424	42424	PrCS	Target
01A8H	40425	42425	PGAP	PFB dead band
01A9H	40426	42426	TRvL	Valve stroke time
01ABH	40428	42428	CAL	PFB input adjustment
01ACH	40429	42429	rMP	Ramp SV on/off
01ADH	40430	42430	rMPL	Ramp SV-decline
01AEH	40431	42431	rMPh	Ramp SV-incline
01AFH	40432	42432	rMPU	Ramp SV slope time unit
01B0H	40433	42433	SvT	Ramp SV - display mode
01B1H	40434	42434	STMd	Startup mode
01B2H	40435	42435	dT	Control operation cycle
01B3H	40436	42436	ALPA	2-degrees-of-freedom coefficient $\alpha$
01B4H	40437	42437	bEIA	2-degrees-of-freedom coefficient $\beta$
01C2H	40451	42451	dP01	Parameter mask
01C3H	40452	42452	dP02	Parameter mask
01C4H	40453	42453	dP03	Parameter mask
01C5H	40454	42454	dP04	Parameter mask
01C6H	40455	42455	dP05	Parameter mask
01C7H	40456	42456	dP06	Parameter mask
01C8H	40457	42457	dP07	Parameter mask
01C9H	40458	42458	dP08	Parameter mask
01CAH	40459	42459	dP09	Parameter mask
01CBH	40460	42460	dP10	Parameter mask
01CCH	40461	42461	dP11	Parameter mask
01CDH	40462	42462	dP12	Parameter mask
01CEH	40463	42463	dP13	Parameter mask
01CFH	40464	42464	dP14	Parameter mask
01D0H	40465	42465	dP15	Parameter mask
01D1H	40466	42466	dP16	Parameter mask
01D2H	40467	42467	dP17	Parameter mask
01D3H	40468	42468	dP18	Parameter mask
01D4H	40469	42469	dP19	Parameter mask
01D5H	40470	42470	dP20	Parameter mask
01D6H	40471	42471	dP21	Parameter mask
01D7H	40472	42472	dP22	Parameter mask
01D8H	40473	42473	dP23	Parameter mask
01D9H	40474	42474	dP24	Parameter mask
01DAH	40475	42475	dP25	Parameter mask
01DBH	40476	42476	dP26	Parameter mask
01DCH	40477	42477	dP27	Parameter mask
01DDH	40478	42478	dP28	Parameter mask
01DEH	40479	42479	dP29	Parameter mask
01DFH	40480	42480	dP30	Parameter mask
01E0H	40481	42481	dP31	Parameter mask
0209H	40522	42522	PAS1	Password1 setup
020AH	40523	42523	PAS2	Password2 setup
020BH	40524	42524	PAS3	Password3 setup
0211H	40530	42530	-	-
0212H	40531	42531	ToUT	Operation timeout
0213H	40532	42532	LOFF	Display timeout
0214H	40533	42533	R-Fk	SV display during RSV
0215H	40534	42534	SoFk	Blinking SV during soft start
0216H	40535	42535	ALMF	Blinking PV/SV at ALM
0218H	40537	42537	bCon	Control at burnout
0219H	40538	42538	DSPT	PV/SV Display off
021AH	40539	42539	FLTF	Blinking PV at input error
021BH	40540	42540	BLIT	Brightness
021CH	40541	42541	LOU1	LED indicator assignment (OUT1)
021DH	40542	42542	LOU2	LED indicator assignment (OUT2)

Relative address	Register No.		Name	Contents
	Internal	Engineering unit		
021EH	40543	42543	LEV1	LED indicator assignment (EV1)
021FH	40544	42544	LEV2	LED indicator assignment (EV2)
0220H	40545	42545	LEV3	LED indicator assignment (EV3)
0221H	40546	42546	LEV4	LED indicator assignment (EV4)
0222H	40547	42547	LEV5	LED indicator assignment (EV5)
0223H	40548	42548	LEV6	LED indicator assignment (EV6)
0224H	40549	42549	LSTB	LED indicator assignment (STBY)
0225H	40550	42550	LMAN	LED indicator assignment (MANU)
0230H	40561	42561	PTn	Ramp soak operation pattern
0231H	40562	42562	TiMu	Ramp/soak time units
0232H	40563	42563	Mod	Ramp soak mode
0233H	40564	42564	PTnM	Max pattern selection
0234H	40565	42565	PMIn	Min pattern selection
023AH	40571	42571	GSoK	Guarantee soak ON/OFF
023BH	40572	42572	GS-L	Guaranty soak (lower limit)
023CH	40573	42573	GS-h	Guaranty soak (upper limit)
023DH	40574	42574	PvST	PV start
023EH	40575	42575	ConT	Restore mode
0244H	40581	42581	Sv-1	Ramp soak 1 seg/SV
0245H	40582	42582	TM1r	Ramp soak 1 seg ramp time
0246H	40583	42583	TM1S	Ramp soak 1 seg soak time
0247H	40584	42584	Sv-2	Ramp soak 2 seg/SV
0248H	40585	42585	TM2r	Ramp soak 2 seg ramp time
0249H	40586	42586	TM2S	Ramp soak 2 seg soak time
024AH	40587	42587	Sv-3	Ramp soak 3 seg/SV
024BH	40588	42588	TM3r	Ramp soak 3 seg ramp time
024CH	40589	42589	TM3S	Ramp soak 3 seg soak time
024DH	40590	42590	Sv-4	Ramp soak 4 seg/SV
024EH	40591	42591	TM4r	Ramp soak 4 seg ramp time
024FH	40592	42592	TM4S	Ramp soak 4 seg soak time
0250H	40593	42593	Sv-5	Ramp soak 5 seg/SV
0251H	40594	42594	TM5r	Ramp soak 5 seg ramp time
0252H	40595	42595	TM5S	Ramp soak 5 seg soak time
0253H	40596	42596	Sv-6	Ramp soak 6 seg/SV
0254H	40597	42597	TM6r	Ramp soak 6 seg ramp time
0255H	40598	42598	TM6S	Ramp soak 6 seg soak time
0256H	40599	42599	Sv-7	Ramp soak 7 seg/SV
0257H	40600	42600	TM7r	Ramp soak 7 seg ramp time
0258H	40601	42601	TM7S	Ramp soak 7 seg soak time
0259H	40602	42602	Sv-8	Ramp soak 8 seg/SV
025AH	40603	42603	TM8r	Ramp soak 8 seg ramp time
025BH	40604	42604	TM8S	Ramp soak 8 seg soak time
025CH	40605	42605	Sv-9	Ramp soak 9 seg/SV
025DH	40606	42606	TM9r	Ramp soak 9 seg ramp time
025EH	40607	42607	TM9S	Ramp soak 9 seg soak time
025FH	40608	42608	Sv10	Ramp soak 10 seg/SV
0260H	40609	42609	T10r	Ramp soak 10 seg ramp time
0261H	40610	42610	T10S	Ramp soak 10 seg soak time
0262H	40611	42611	Sv11	Ramp soak 11 seg/SV
0263H	40612	42612	T11r	Ramp soak 11 seg ramp time
0264H	40613	42613	T11S	Ramp soak 11 seg soak time
0265H	40614	42614	Sv12	Ramp soak 12 seg/SV
0266H	40615	42615	T12r	Ramp soak 12 seg ramp time
0267H	40616	42616	T12S	Ramp soak 12 seg soak time
0268H	40617	42617	Sv13	Ramp soak 13 seg/SV
0269H	40618	42618	T13r	Ramp soak 13 seg ramp time
026AH	40619	42619	T13S	Ramp soak 13 seg soak time
026BH	40620	42620	Sv14	Ramp soak 14 seg/SV
026CH	40621	42621	T14r	Ramp soak 14 seg ramp time
026DH	40622	42622	T14S	Ramp soak 14 seg soak time
026EH	40623	42623	Sv15	Ramp soak 15 seg/SV
026FH	40624	42624	T15r	Ramp soak 15 seg ramp time
0270H	40625	42625	T15S	Ramp soak 15 seg soak time
0271H	40626	42626	Sv16	Ramp soak 16 seg/SV
0272H	40627	42627	T16r	Ramp soak 16 seg ramp time
0273H	40628	42628	T16S	Ramp soak 16 seg soak time
0274H	40629	42629	Sv17	Ramp soak 17 seg/SV
0275H	40630	42630	T17r	Ramp soak 17 seg ramp time
0276H	40631	42631	T17S	Ramp soak 17 seg soak time
0277H	40632	42632	Sv18	Ramp soak 18 seg/SV
0278H	40633	42633	T18r	Ramp soak 18 seg ramp time
0279H	40634	42634	T18S	Ramp soak 18 seg soak time
027AH	40635	42635	Sv19	Ramp soak 19 seg/SV
027BH	40636	42636	T19r	Ramp soak 19 seg ramp time
027CH	40637	42637	T19S	Ramp soak 19 seg soak time
027DH	40638	42638	Sv20	Ramp soak 20 seg/SV
027EH	40639	42639	T20r	Ramp soak 20 seg ramp time
027FH	40640	42640	T20S	Ramp soak 20 seg soak time
0280H	40641	42641	Sv21	Ramp soak 21 seg/SV
0281H	40642	42642	T21r	Ramp soak 21 seg ramp time
0282H	40643	42643	T21S	Ramp soak 21 seg soak time
0283H	40644	42644	Sv22	Ramp soak 22 seg/SV
0284H	40645	42645	T22r	Ramp soak 22 seg ramp time

Relative address	Register No.		Name	Contents
	Internal	Engineering unit		
0285H	40646	42646	T22S	Ramp soak 22 seg soak time
0286H	40647	42647	Sv23	Ramp soak 23 seg/SV
0287H	40648	42648	T23r	Ramp soak 23 seg ramp time
0288H	40649	42649	T23S	Ramp soak 23 seg soak time
0289H	40650	42650	Sv24	Ramp soak 24 seg/SV
028AH	40651	42651	T24r	Ramp soak 24 seg ramp time
028BH	40652	42652	T24S	Ramp soak 24 seg soak time
028CH	40653	42653	Sv25	Ramp soak 25 seg/SV
028DH	40654	42654	T25r	Ramp soak 25 seg ramp time
028EH	40655	42655	T25S	Ramp soak 25 seg soak time
028FH	40656	42656	Sv26	Ramp soak 26 seg/SV
0290H	40657	42657	T26r	Ramp soak 26 seg ramp time
0291H	40658	42658	T26S	Ramp soak 26 seg soak time
0292H	40659	42659	Sv27	Ramp soak 27 seg/SV
0293H	40660	42660	T27r	Ramp soak 27 seg ramp time
0294H	40661	42661	T27S	Ramp soak 27 seg soak time
0295H	40662	42662	Sv28	Ramp soak 28 seg/SV
0296H	40663	42663	T28r	Ramp soak 28 seg ramp time
0297H	40664	42664	T28S	Ramp soak 28 seg soak time
0298H	40665	42665	Sv29	Ramp soak 29 seg/SV
0299H	40666	42666	T29r	Ramp soak 29 seg ramp time
029AH	40667	42667	T29S	Ramp soak 29 seg soak time
029BH	40668	42668	Sv30	Ramp soak 30 seg/SV
029CH	40669	42669	T30r	Ramp soak 30 seg ramp time
029DH	40670	42670	T30S	Ramp soak 30 seg soak time
029EH	40671	42671	Sv31	Ramp soak 31 seg/SV
029FH	40672	42672	T31r	Ramp soak 31 seg ramp time
02A0H	40673	42673	T31S	Ramp soak 31 seg soak time
02A1H	40674	42674	Sv32	Ramp soak 32 seg/SV
02A2H	40675	42675	T32r	Ramp soak 32 seg ramp time
02A3H	40676	42676	T32S	Ramp soak 32 seg soak time
02A4H	40677	42677	Sv33	Ramp soak 33 seg/SV
02A5H	40678	42678	T33r	Ramp soak 33 seg ramp time
02A6H	40679	42679	T33S	Ramp soak 33 seg soak time
02A7H	40680	42680	Sv34	Ramp soak 34 seg/SV
02A8H	40681	42681	T34r	Ramp soak 34 seg ramp time
02A9H	40682	42682	T34S	Ramp soak 34 seg soak time
02AAH	40683	42683	Sv35	Ramp soak 35 seg/SV
02ABH	40684	42684	T35r	Ramp soak 35 seg ramp time
02ACH	40685	42685	T35S	Ramp soak 35 seg soak time
02ADH	40686	42686	Sv36	Ramp soak 36 seg/SV
02AEH	40687	42687	T36r	Ramp soak 36 seg ramp time
02AFH	40688	42688	T36S	Ramp soak 36 seg soak time
02B0H	40689	42689	Sv37	Ramp soak 37 seg/SV
02B1H	40690	42690	T37r	Ramp soak 37 seg ramp time
02B2H	40691	42691	T37S	Ramp soak 37 seg soak time
02B3H	40692	42692	Sv38	Ramp soak 38 seg/SV
02B4H	40693	42693	T38r	Ramp soak 38 seg ramp time
02B5H	40694	42694	T38S	Ramp soak 38 seg soak time
02B6H	40695	42695	Sv39	Ramp soak 39 seg/SV
02B7H	40696	42696	T39r	Ramp soak 39 seg ramp time
02B8H	40697	42697	T39S	Ramp soak 39 seg soak time
02B9H	40698	42698	Sv40	Ramp soak 40 seg/SV
02BAH	40699	42699	T40r	Ramp soak 40 seg ramp time
02BBH	40700	42700	T40S	Ramp soak 40 seg soak time
02BCH	40701	42701	Sv41	Ramp soak 41 seg/SV
02BDH	40702	42702	T41r	Ramp soak 41 seg ramp time
02BEH	40703	42703	T41S	Ramp soak 41 seg soak time
02BFH	40704	42704	Sv42	Ramp soak 42 seg/SV
02COH	40705	42705	T42r	Ramp soak 42 seg ramp time
02C1H	40706	42706	T42S	Ramp soak 42 seg soak time
02C2H	40707	42707	Sv43	Ramp soak 43 seg/SV
02C3H	40708	42708	T43r	Ramp soak 43 seg ramp time
02C4H	40709	42709	T43S	Ramp soak 43 seg soak time
02C5H	40710	42710	Sv44	Ramp soak 44 seg/SV
02C6H	40711	42711	T44r	Ramp soak 44 seg ramp time
02C7H	40712	42712	T44S	Ramp soak 44 seg soak time
02C8H	40713	42713	Sv45	Ramp soak 45 seg/SV
02C9H	40714	42714	T45r	Ramp soak 45 seg ramp time
02CAH	40715	42715	T45S	Ramp soak 45 seg soak time
02CBH	40716	42716	Sv46	Ramp soak 46 seg/SV
02CCH	40717	42717	T46r	Ramp soak 46 seg ramp time
02CDH	40718	42718	T46S	Ramp soak 46 seg soak time
02CEH	40719	42719	Sv47	Ramp soak 47 seg/SV
02CFH	40720	42720	T47r	Ramp soak 47 seg ramp time
02D0H	40721	42721	T47S	Ramp soak 47 seg soak time
02D1H	40722	42722	Sv48	Ramp soak 48 seg/SV
02D2H	40723	42723	T48r	Ramp soak 48 seg ramp time
02D3H	40724	42724	T48S	Ramp soak 48 seg soak time
02D4H	40725	42725	Sv49	Ramp soak 49 seg/SV
02D5H	40726	42726	T49r	Ramp soak 49 seg ramp time
02D6H	40727	42727	T49S	Ramp soak 49 seg soak time
02D7H	40728	42728	Sv50	Ramp soak 50 seg/SV



Relative address	Register No.		Name	Contents
	Internal	Engineering unit		
02D8H	40729	42729	T50r	Ramp soak 50 seg ramp time
02D9H	40730	42730	T50S	Ramp soak 50 seg soak time
02DAH	40731	42731	Sv51	Ramp soak 51 seg/SV
02DBH	40732	42732	T51r	Ramp soak 51 seg ramp time
02DCH	40733	42733	T51S	Ramp soak 51 seg soak time
02DDH	40734	42734	Sv52	Ramp soak 52 seg/SV
02DEH	40735	42735	T52r	Ramp soak 52 seg ramp time
02DFH	40736	42736	T52S	Ramp soak 52 seg soak time
02E0H	40737	42737	Sv53	Ramp soak 53 seg/SV
02E1H	40738	42738	T53r	Ramp soak 53 seg ramp time
02E2H	40739	42739	T53S	Ramp soak 53 seg soak time
02E3H	40740	42740	Sv54	Ramp soak 54 seg/SV
02E4H	40741	42741	T54r	Ramp soak 54 seg ramp time
02E5H	40742	42742	T54S	Ramp soak 54 seg soak time
02E6H	40743	42743	Sv55	Ramp soak 55 seg/SV
02E7H	40744	42744	T55r	Ramp soak 55 seg ramp time
02E8H	40745	42745	T55S	Ramp soak 55 seg soak time
02E9H	40746	42746	Sv56	Ramp soak 56 seg/SV
02EAH	40747	42747	T56r	Ramp soak 56 seg ramp time
02EBH	40748	42748	T56S	Ramp soak 56 seg soak time
02ECH	40749	42749	Sv57	Ramp soak 57 seg/SV
02EDH	40750	42750	T57r	Ramp soak 57 seg ramp time
02EEH	40751	42751	T57S	Ramp soak 57 seg soak time
02EFH	40752	42752	Sv58	Ramp soak 58 seg/SV
02F0H	40753	42753	T58r	Ramp soak 58 seg ramp time
02F1H	40754	42754	T58S	Ramp soak 58 seg soak time
02F2H	40755	42755	Sv59	Ramp soak 59 seg/SV
02F3H	40756	42756	T59r	Ramp soak 59 seg ramp time
02F4H	40757	42757	T59S	Ramp soak 59 seg soak time
02F5H	40758	42758	Sv60	Ramp soak 60 seg/SV
02F6H	40759	42759	T60r	Ramp soak 60 seg ramp time
02F7H	40760	42760	T60S	Ramp soak 60 seg soak time
02F8H	40761	42761	Sv61	Ramp soak 61 seg/SV
02F9H	40762	42762	T61r	Ramp soak 61 seg ramp time
02FAH	40763	42763	T61S	Ramp soak 61 seg soak time
02FBH	40764	42764	Sv62	Ramp soak 62 seg/SV
02FCH	40765	42765	T62r	Ramp soak 62 seg ramp time
02FDH	40766	42766	T62S	Ramp soak 62 seg soak time
02FEH	40767	42767	Sv63	Ramp soak 63 seg/SV
02FFH	40768	42768	T63r	Ramp soak 63 seg ramp time
0300H	40769	42769	T63S	Ramp soak 63 seg soak time
0301H	40770	42770	Sv64	Ramp soak 64 seg/SV
0302H	40771	42771	T64r	Ramp soak 64 seg ramp time
0303H	40772	42772	T64S	Ramp soak 64 seg soak time
031FH	40800	42800	WCMd	Electric power calculation command
0321H	40802	42802	Volt	Fixed voltage value
0322H	40803	42803	Cur	Current value for simple power calculation
0324H	40805	42805	WdP	Decimal point position for electric power
0325H	40806	42806	Phy	Power factor for simple calculation
0326H	40807	42807	RyCn	Upper limit of relay contact operation
0327H	40808	42808	OpTm	Upper limit of operation days
033EH	40831	42831	MATH	Simple calculation ON/OFF
033FH	40832	42832	W1MA	Wafer 1 Calculation
0340H	40833	42833	W1i1	Wafer 1 Input 1
0341H	40834	42834	W1i2	Wafer 1 Input 2
0342H	40835	42835	W1i3	Wafer 1 Input 3
0343H	40836	42836	W2MA	Wafer 2 Calculation
0344H	40837	42837	W2i1	Wafer 2 Input 1
0345H	40838	42838	W2i2	Wafer 2 Input 2
0346H	40839	42839	W2i3	Wafer 2 Input 3
0347H	40840	42840	W3MA	Wafer 3 Calculation
0348H	40841	42841	W3i1	Wafer 3 Input 1
0349H	40842	42842	W3i2	Wafer 3 Input 2
034AH	40843	42843	W3i3	Wafer 3 Input 3
034BH	40844	42844	W4MA	Wafer 4 Calculation
034CH	40845	42845	W4i1	Wafer 4 Input 1
034DH	40846	42846	W4i2	Wafer 4 Input 2
034EH	40847	42847	W4i3	Wafer 4 Input 3
034FH	40848	42848	W5MA	Wafer 5 Calculation
0350H	40849	42849	W5i1	Wafer 5 Input 1
0351H	40850	42850	W5i2	Wafer 5 Input 2
0352H	40851	42851	W5i3	Wafer 5 Input 3
0353H	40852	42852	W6MA	Wafer 6 Calculation
0354H	40853	42853	W6i1	Wafer 6 Input 1
0355H	40854	42854	W6i2	Wafer 6 Input 2
0356H	40855	42855	W6i3	Wafer 6 Input 3
0357H	40856	42856	W7MA	Wafer 7 Calculation
0358H	40857	42857	W7i1	Wafer 7 Input 1
0359H	40858	42858	W7i2	Wafer 7 Input 2
035AH	40859	42859	W7i3	Wafer 7 Input 3
035BH	40860	42860	W8MA	Wafer 8 Calculation
035CH	40861	42861	W8i1	Wafer 8 Input 1
035DH	40862	42862	W8i2	Wafer 8 Input 2

Relative address	Register No.		Name	Contents
	Internal	Engineering unit		
035EH	40863	42863	W8i3	Wafer 8 Input 3
035FH	40864	42864	W9MA	Wafer 9 Calculation
0360H	40865	42865	W9i1	Wafer 9 Input 1
0361H	40866	42866	W9i2	Wafer 9 Input 2
0362H	40867	42867	W9i3	Wafer 9 Input 3
0363H	40868	42868	WAMA	Wafer 10 Calculation
0364H	40869	42869	WAI1	Wafer 10 Input 1
0365H	40870	42870	WAI2	Wafer 10 Input 2
0366H	40871	42871	WAI3	Wafer 10 Input 3
0367H	40872	42872	CON1	Constant 1
0368H	40873	42873	CON2	Constant 2
0369H	40874	42874	CON3	Constant 3
036AH	40875	42875	CON4	Constant 4
036BH	40876	42876	CON5	Constant 5
036CH	40877	42877	CON6	Constant 6
036DH	40878	42878	CON7	Constant 7
036EH	40879	42879	CON8	Constant 8
036FH	40880	42880	CON9	Constant 9
0370H	40881	42881	CONA	Constant 10
0384H	40901	42901	CIYP	Communication type
0385H	40902	42902	STno	Station No.
0386H	40903	42903	SPED	RS-485 baud rate
0387H	40904	42904	PrTy	RS-485 parity
0388H	40905	42905	intv	RS-485 response interval
0389H	40906	42906	RvWt	RS-485 receive timeout
038AH	40907	42907	RvCt	RS-485 send retry times
038BH	40908	42908	SCC	Communication permissions
038CH	40909	42909	MxSt	Max. station number
038DH	40910	42910	UA01	MODBUS user address setting 1
038EH	40911	42911	UA02	MODBUS user address setting 2
038FH	40912	42912	UA03	MODBUS user address setting 3
0390H	40913	42913	UA04	MODBUS user address setting 4
0391H	40914	42914	UA05	MODBUS user address setting 5
0392H	40915	42915	UA06	MODBUS user address setting 6
0393H	40916	42916	UA07	MODBUS user address setting 7
0394H	40917	42917	UA08	MODBUS user address setting 8
0395H	40918	42918	UA09	MODBUS user address setting 9
0396H	40919	42919	UA10	MODBUS user address setting 10
0397H	40920	42920	UA11	MODBUS user address setting 11
0398H	40921	42921	UA12	MODBUS user address setting 12
0399H	40922	42922	UA13	MODBUS user address setting 13
039AH	40923	42923	UA14	MODBUS user address setting 14
039BH	40924	42924	UA15	MODBUS user address setting 15
039CH	40925	42925	UA16	MODBUS user address setting 16
039DH	40926	42926	UA17	MODBUS user address setting 17
039EH	40927	42927	UA18	MODBUS user address setting 18
039FH	40928	42928	UA19	MODBUS user address setting 19
03A0H	40929	42929	UA20	MODBUS user address setting 20
03A1H	40930	42930	UA21	MODBUS user address setting 21
03A2H	40931	42931	UA22	MODBUS user address setting 22
03A3H	40932	42932	UA23	MODBUS user address setting 23
03A4H	40933	42933	UA24	MODBUS user address setting 24
03A5H	40934	42934	UA25	MODBUS user address setting 25
03A6H	40935	42935	UA26	MODBUS user address setting 26
03A7H	40936	42936	UA27	MODBUS user address setting 27
03A8H	40937	42937	UA28	MODBUS user address setting 28
03A9H	40938	42938	UA29	MODBUS user address setting 29
03AAH	40939	42939	UA30	MODBUS user address setting 30
03ABH	40940	42940	UA31	MODBUS user address setting 31
03ACH	40941	42941	UA32	MODBUS user address setting 32
03ADH	40942	42942	CSVG	Communication SV gain
03AEH	40943	42943	CSVs	Communication SV shift
03AFH	40944	42944	APCy	All parameters copy
03B0H	40945	42945	PLSt	Target PLC station No.
03B1H	40946	42946	PAdk	Registration number allocation rule
03B2H	40947	42947	MSWt	Communication interval among stations
03B3H	40948	42948	PLWt	Communication interval between station and PLC
03B4H	40949	42949	PLAd	Starting register number in programless communication
03B5H	40950	42950	SA01	MODBUS address 1 for the setting area
03B6H	40951	42951	SA02	MODBUS address 2 for the setting area
03B7H	40952	42952	SA03	MODBUS address 3 for the setting area
03B8H	40953	42953	SA04	MODBUS address 4 for the setting area
03B9H	40954	42954	SA05	MODBUS address 5 for the setting area
03BAH	40955	42955	SA06	MODBUS address 6 for the setting area
03BBH	40956	42956	SA07	MODBUS address 7 for the setting area
03BCH	40957	42957	SA08	MODBUS address 8 for the setting area
03BDH	40958	42958	SA09	MODBUS address 9 for the setting area
03BEH	40959	42959	SA10	MODBUS address 10 for the setting area
03BFH	40960	42960	SA11	MODBUS address 11 for the setting area
03C0H	40961	42961	SA12	MODBUS address 12 for the setting area
03C1H	40962	42962	SA13	MODBUS address 13 for the setting area
03C2H	40963	42963	SA14	MODBUS address 14 for the setting area
03C3H	40964	42964	SA15	MODBUS address 15 for the setting area

Relative address	Register No.		Name	Contents
	Internal	Engineering unit		
03C4H	40965	42965	SA16	MODBUS address 16 for the setting area
03C5H	40966	42966	MA01	MODBUS address 1 for the monitor area
03C6H	40967	42967	MA02	MODBUS address 2 for the monitor area
03C7H	40968	42968	MA03	MODBUS address 3 for the monitor area
03C8H	40969	42969	MA04	MODBUS address 4 for the monitor area
03C9H	40970	42970	MA05	MODBUS address 5 for the monitor area
03CAH	40971	42971	MA06	MODBUS address 6 for the monitor area
03CBH	40972	42972	MA07	MODBUS address 7 for the monitor area
03CCH	40973	42973	MA08	MODBUS address 8 for the monitor area
03CDH	40974	42974	MA09	MODBUS address 9 for the monitor area
03CEH	40975	42975	MA10	MODBUS address 10 for the monitor area
03CFH	40976	42976	MA11	MODBUS address 11 for the monitor area
03D0H	40977	42977	MA12	MODBUS address 12 for the monitor area
03D1H	40978	42978	MA13	MODBUS address 13 for the monitor area
03D2H	40979	42979	MA14	MODBUS address 14 for the monitor area
03D3H	40980	42980	MA15	MODBUS address 15 for the monitor area
03D4H	40981	42981	MA16	MODBUS address 16 for the monitor area
03D5H	40982	42982	KYKd	Cooperative operation items
1388H	45001	47001		User address area 1
1389H	45002	47002		User address area 2
138AH	45003	47003		User address area 3
138BH	45004	47004		User address area 4
138CH	45005	47005		User address area 5
138DH	45006	47006		User address area 6
138EH	45007	47007		User address area 7

Relative address	Register No.		Name	Contents
	Internal	Engineering unit		
138FH	45008	47008		User address area 8
1390H	45009	47009		User address area 9
1391H	45010	47010		User address area 10
1392H	45011	47011		User address area 11
1393H	45012	47012		User address area 12
1394H	45013	47013		User address area 13
1395H	45014	47014		User address area 14
1396H	45015	47015		User address area 15
1397H	45016	47016		User address area 16
1398H	45017	47017		User address area 17
1399H	45018	47018		User address area 18
139AH	45019	47019		User address area 19
139BH	45020	47020		User address area 20
139CH	45021	47021		User address area 21
139DH	45022	47022		User address area 22
139EH	45023	47023		User address area 23
139FH	45024	47024		User address area 24
13A0H	45025	47025		User address area 25
13A1H	45026	47026		User address area 26
13A2H	45027	47027		User address area 27
13A3H	45028	47028		User address area 28
13A4H	45029	47029		User address area 29
13A5H	45030	47030		User address area 30
13A6H	45031	47031		User address area 31
13A7H	45032	47032		User address area 32

## Word data (read only): Function code [04(H)]

### Ch 4 MON (monitor parameters)

No.	Value		Function	Relative address	Register No.		Read data	Written data range	Factory-set value	Dependent on range	Remarks
	Display	Name			Internal	Engineering unit					
420	STAT	Ramp soak progress	Displays the progress of the ramp soak	0028 H	30041	32041	0: oFF (ramp soak stopped) 1: 1-rP (ramp in step 1) 2: 1-Sk (soak in step 1) ⋮ 127: 64rP (ramp in step 64) 128: 64Sk (soak in step 64) 129: End (ramp soak finished)	-			
421	Mv1	MV1(%)	Displays the output value of the control output (OUT1)	0029 H	30042	32042	-500 to 10500 (-5.0 to 105.0%)	-			
422	Mv2	MV2(%)	Displays the output value of the control output (OUT2)	002A H	30043	32043	-500 to 10500 (-5.0 to 105.0%)	-			
423	Pfb	PFB input value (%)	Displays the position feedback input value.	002B H	30044	32044	-1000 to 11000 (-10.0 to 110.0%)	-			
424	RSV	Remote SV	Shows a remote SV.	002C H	30045	32045	-500 to 10500 (-5.0 to 105.0%)	-	○		
425	Ct1	Heater current (A)	Shows a heater current value. (A current value when OUT1 is ON.)	002D H	30046	32046	0 to 11000 (0 to 110.0 A)	-			
427	LC1	SSR leak current (A)	Shows a leak current value. (A current value when OUT1 is OFF.)	002F H	30048	32048	0 to 11000 (0 to 110.0 A)	-			
429	TM1	Remaining time on timer 1	Displays the remaining time on timer 1	0064 H	30101	32101	0 to 9999 (0 to 9999 sec./0 to 9999 min.)	-			
430	TM2	Remaining time on timer 2	Displays the remaining time on timer 2	0065 H	30102	32102	0 to 9999 (0 to 9999 sec./0 to 9999 min.)	-			
431	TM3	Remaining time on timer 3	Displays the remaining time on timer 3	0066 H	30103	32103	0 to 9999 (0 to 9999 sec./0 to 9999 min.)	-			
432	TM4	Remaining time on timer 4	Displays the remaining time on timer 4	0067 H	30104	32104	0 to 9999 (0 to 9999 s/0 to 9999 min)	-			
433	TM5	Remaining time on timer 5	Displays the remaining time on timer 5	0068 H	30105	32105	0 to 9999 (0 to 9999 s/0 to 9999 min)	-			
435	COMM	Communication status	Displays the communication status.	006D H	30110	32110	0 to 9999 (0 to 9999 times)	-			
436	CUR1	Current 1	Shows a current value measured by CT.	0031 H	30050	32050	0 to 11000 (0 to 110.0 A)	-			
438	W	Electric power	Shows a calculated value of electric power.	006E H	30111	32111	0 to 9999 (0 to 9999 KW)	-			
439	KWH	Power	Displays the calculated amount of electric power.	006F H	30112	32112	0 to 9999 (0 to 9999 Wh)	-			
440	RCN1	Number of operating times (control relay 1)	Displays the number of times that control output relay 1 has operated.	0070 H	30113	32113	0 to 9999 (0 to 9999 k times)	-			
441	RCN2	Number of operating times (control relay 2)	Displays the number of times that control output relay 2 has operated.	0071 H	30114	32114	0 to 9999 (0 to 9999 k times)	-			
442	RUNt	Operating days	Displays the number of days that the controller has operated.	0072 H	30115	32115	0 to 5000 (0 to 5000 days)	-			
443	FALT	Error source	Displays the source of an error	0036 H	30055	32055	0 bit: PV input underflow (LLLL) 1 bit: PV input overflow (UUUU) 2 bit: PV underrange 3 bit: PV overrange 4 bit: RSV underrange 5 bit: RSV overrange 6 bit: Range setting error 8 bit: PV input circuit error 9 bit: R-SV input circuit error 10 bit: CT/PFB input circuit error 11 bit: PFB input underrange 12 bit: PFB input overrange	-			
444	DI	DI input state	Displays the state of DI.	000E H	30015	32015	0 bit DI1 1 bit DI2 2 bit DI3	-			
445	ERSt	Communication error station number	Shows the station number under a cooperative communication error or a programless communication error.	008C H	30141	32141	0 to 31	-			
446	PLNo	Current PID No.	Displays the currently used PID number.	0038 H	30057	32057	0 to 7	-			
447	PtNo	Current pattern No.	Displays the ramp soak pattern number being used.	0039 H	30058	32058	0 to 15	-			

## Ch 12 CFG (configuration parameters)

No.	Display	Value		Function	Relative address	Register No.		Read data	Written data range	Factory-set value	Dependent on range	Remarks
		Name				Internal	Engineering unit					
950	PL01	Model code		Shows model code	0046 H	30071	32071	P		P		
951	PL02				0047 H	30072	32072	X		X		
952	PL03				0048 H	30073	32073	F		F		
953	PL04				0049 H	30074	32074	Value differs depending on the model.		Value differs depending on the model.		
954	PL05				004A H	30075	32075					
955	PL06				004B H	30076	32076					
956	PL07				004C H	30077	32077					
957	PL08				004D H	30078	32078					
958	PL09				004E H	30079	32079					
959	PL10				004F H	30080	32080					
960	PL11				0050 H	30081	32081					
961	PL12				0051 H	30082	32082					
962	PL13				0052 H	30083	32083					
965	VER1	Software version		Shows the software version	0010 H	30017	32017	-		-		
966	VER2				0011 H	30018	32018					
967	VER3				0012 H	30019	32019					
968	VER4				0013 H	30020	32020					

## Others

No.	Display	Value		Function	Relative address	Register No.		Read data	Written data range	Factory-set value	Dependent on range	Remarks
		Name				Internal	Engineering unit					
-	PV	PV (process value)		Displays PV (process value).	0000 H	30001	32001	0 to 100%FS		0.00%FS	○	
-	SV	SV (set value)		Displays SV (set value) under use.	0001 H	30002	32002	0 to 100%FS		0.00%FS	○	

## [ALM STATUS]

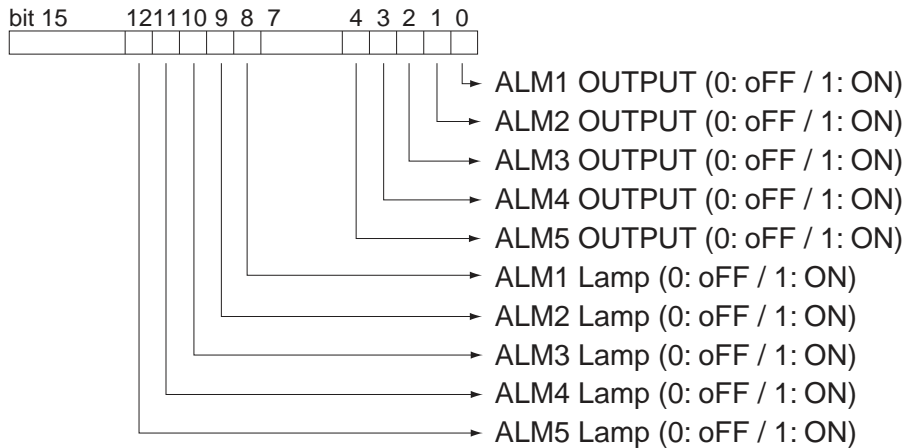



## Resistor Number Order Read/Write Parameter List

Relative address	Register No.		Name	Contents
	Internal	Engineering unit		
0000H	30001	32001	PV	PV (process value)
0001H	30002	32002	SV	SV (Currently used set value)
0002H	30003	32003	DV	DV (Currently used deviation)
0003H	30004	32004	Mv1	Control output 1
0004H	30005	32005	Mv2	Control output 2
0005H	30006	32006	STNo	Station No.
0006H	30007	32007	DO STAT	DO status
0007H	30008	32008	FALT	FALT status
0008H	30009	32009	STAT	Ramp soak progress
0009H	30010	32010	CT1	Heater current
000AH	30011	32011	TM1	Remaining time on timer 1
000BH	30012	32012	TM2	Remaining time on timer 2
000CH	30013	32013	TM3	Remaining time on timer 3
000EH	30015	32015	DI	DI information
000FH	30016	32016	rCJ	rCJ temperature
0010H	30017	32017	SOFT Ver1	Software version
0011H	30018	32018	SOFT Ver2	
0012H	30019	32019	SOFT Ver3	
0013H	30020	32020	SOFT Ver4	
0024H	30037	32037	RSV	RSV input value
0028H	30041	32041	STAT	Ramp soak progress
0029H	30042	32042	Mv1	Control output 1
002AH	30043	32043	Mv2	Control output 2
002BH	30044	32044	PFB	PFB input value
002CH	30045	32045	RSV	RSV input value
002DH	30046	32046	CT1	Heater current 1
002FH	30048	32048	LC1	Leak current
0031H	30050	32050	CUR1	CT current 1
0036H	30055	32055	FALT	FALT status
0038H	30057	32057	PLno	Current palette No.
0039H	30058	32058	PTno	Current pattern No.
003BH	30060	32060	ALM STATUS	Alarm status
0046H	30071	32071	PILC1	Type
0047H	30072	32072	PILC2	
0048H	30073	32073	PILC3	
0049H	30074	32074	PILC4	
004AH	30075	32075	PILC5	

Relative address	Register No.		Name	Contents
	Internal	Engineering unit		
004BH	30076	32076	PILC6	
004CH	30077	32077	PILC7	
004DH	30078	32078	PILC8	
004EH	30079	32079	PILC9	
004FH	30080	32080	PILC10	
0050H	30081	32081	PILC11	
0051H	30082	32082	PILC12	
0052H	30083	32083	PILC13	
0053H	30084	32084	PILC14	
0054H	30085	32085	PILC15	
0055H	30086	32086	PILC16	
0056H	30087	32087	PILC17	
0057H	30088	32088	PILC18	
0058H	30089	32089	PILC19	
0059H	30090	32090	PILC20	
005AH	30091	32091	SERIAL1	Serial No.
005BH	30092	32092	SERIAL2	
005CH	30093	32093	SERIAL3	
005DH	30094	32094	SERIAL4	
005EH	30095	32095	SERIAL5	
005FH	30096	32096	SERIAL6	
0060H	30097	32097	SERIAL7	
0061H	30098	32098	SERIAL8	
0062H	30099	32099	SERIAL9	
0063H	30100	32100	SERIAL10	
0064H	30101	32101	TM1	Remaining time on timer 1
0065H	30102	32102	TM2	Remaining time on timer 2
0066H	30103	32103	TM3	Remaining time on timer 3
0067H	30104	32104	TM4	Remaining time on timer 4
0068H	30105	32103	TM5	Remaining time on timer 5
006DH	30110	32110	COMM	Communication status
006FH	30112	32112	KWH	Calculated amount of electric power.
0070H	30113	32113	RCnT1	Number of operating times (control relay 1)
0071H	30114	32114	RCnT2	Number of operating times (control relay 2)
0072H	30115	32115	RunT	Operating days
008CH	30141	32141	ERSt	Communication error station number

# **Chapter 8**

## **Sample Program**

Sample Program – 68

# Sample Program

A sample program for reading and writing data that runs on Microsoft Visual Basic 6.0 (SP6) is distributed in our home page. The sample program is meant to be used as a reference for your own program creation, and therefore all its actions are not guaranteed.

Sample program body can be downloaded from our home page indicated below.

Home page address : <http://www.fujielectric.com/products/instruments/> PUM\_Sample\_program.lzh

Before running the program, check the following summary of points for communication conditions.

- Parity, communication speed to be set in this program. Please match these values with the conditions of the PXF.

## Warning when using an RS-232C to RS-485 converter

The sent data is sometimes added to the response data from the slave before it is received. In this case, when receiving the data, process the response data only after first getting rid of the number of bytes from the sent data.

## Compatible OS

Windows 2000 Professional

Windows XP/7 Professional Edition

### Caution

- Windows<sup>®</sup> is a registered trademark of the Microsoft Corporation.
- Visual Basic<sup>®</sup> is a registered trademark of the Microsoft Corporation.

Fuji Electric Systems Co., Ltd. assumes no responsibility for damages or infringement upon third party rights as a result of using this sample program. Use this program while conforming to the contents of the agreement listed within.

# Chapter 9

## Cooperative operation

Overview – 70



Connection – 71



Setup and related parameters – 72



Cooperative operation – 73



List of parameters subject to the cooperative operation – 74

# Overview

When you control one temperature controller, the other controllers follow it. In the cooperative operation, one of the controllers acts as a master, while others act as slaves. When you change the settings of the master controller, a message will be sent to all slave controllers which follow the change. For example, if you set the master device to standby, all the slave devices will go into standby mode.

You can set different offset values or gains for each devices to add to the SV. Also, you can copy all parameter settings to the slaves.

Change of the master SV

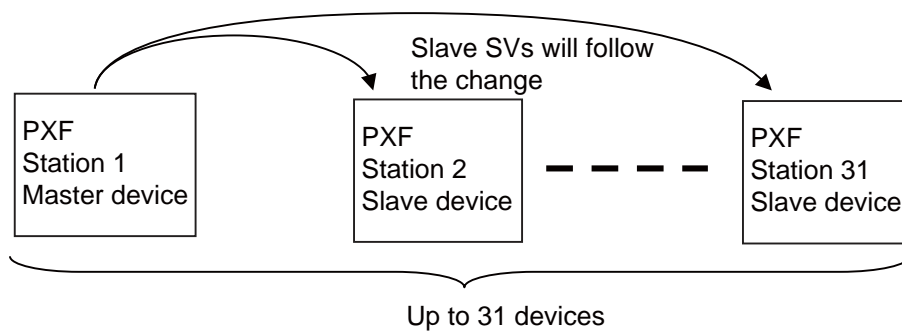

# Connection

Connect the temperature controllers as follows.

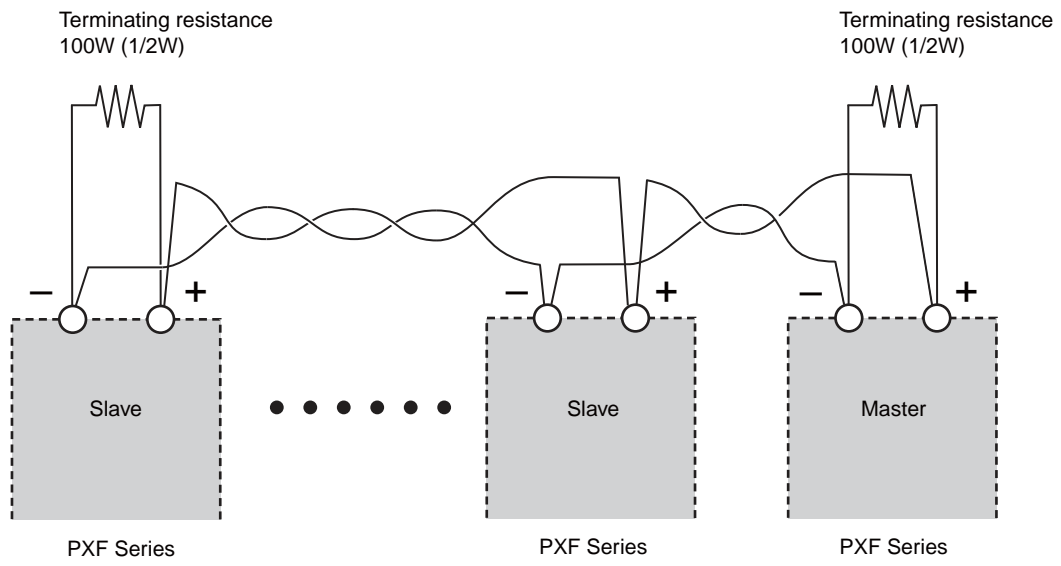

# Setup and related parameters

The following parameters need to be configured to use the cooperative operation.

- Master device

Parameter channel	Screen No.	Parameter display symbol	Name	Setting range	Initial value	Remarks
CH9 CoM	760	CTYP	Communication type	0: MODBUS RTU 1: Cooperative operation 2: Programless communication	0	Select "1: cooperative operation".
	761	StNo	Station No.	0 to 255 (0: unresponsive communication)	1	Sets "1" for the master.
	768	MXSt	Last station No.	0 to 31	0	Set the station number of the last slave.
	803	kykd	Cooperative operation items	0: SV and RUN/standby 1: all parameters	0	Refer to "List of parameters subject to the cooperative operation" for the details of the cooperative operation parameters.

- Slave devices

Parameter channel	Screen No.	Parameter display symbol	Name	Setting range	Initial value	Remarks
CH9 CoM	760	CTYP	Communication type	0: MODBUS RTU 1: Cooperative operation 2: Programless communication	0	Select "1: cooperative operation".
	761	StNo	Station No.	0 to 255 (0: unresponsive communication)	1	Allocate the sequential numbers starting from "2" for slave devices. (Note) Do not skip any numbers.
	801	CSVG	Communication SV gain	1 to 9999 (0.001 to 9.999)	1000	Configure the gain to be added to SV changed through cooperative operation.
	802	CSVS	Communication SV shift	-10000 to 10000 (-100.00 to 100.00% FS)	0	Configure the shift value to be added to SV changed through cooperative operation.

To copy all parameter settings of the master to all slaves, use the following parameter.

- Parameter of master device

Parameter channel	Screen No.	Parameter display symbol	Name	Setting range	Initial value	Remarks
CH9 CoM	804	APCY	All parameters copy	0: not to copy 1: copy	0	Refer to "List of parameters subject to the cooperative operation" for the details of the parameters to be copied.

To check the communication status, use the following parameter.

- Parameter of master device

Parameter channel	Screen No.	Parameter display symbol	Name	Setting range	Initial value	Remarks
CH4 MoN	445	ERSt	Communication error station number	Shows the station number under a cooperative communication error or a programless communication error.	-	If communication error occurs in several devices, the display shows their station numbers in turn for 2 seconds each.

# Cooperative operation

- When you change the setting of a parameter that is subject to cooperative operation, parameter settings of all slave devices will change accordingly.
- You can select the target parameters of cooperative operation in "the screen No. 803, kykd: Cooperative operation items". Refer to 4-5 for the details of the cooperative operation parameters.
- You can add offset and gain to the SV for each slave as follows.  
Calculating formula: Slave's SV = Master's SV x Communication SV gain + Communication SV shift
- The settings of selected parameters can be copied from the master to all slaves. To start copy, set "the screen No. 804, APCY: All parameters copy" to "1". (Copying takes 30 seconds maximum per device to complete.)
- During cooperative operation, the indicator lamp "A" on the LCD blinks. and key operation is disabled.





# List of parameters subject to the cooperative operation

○: Target of cooperative operation    ○: Target of copy

	Screen No.	Parameter		kykd: Cooperative operation items		Target of copy
		Display	Name	0	1	
Operation screen	-	SV	PV/SV display	○	○	○
	-	PV/MV	PV/MV display	-	-	-
	-	PV/KWh	PV/Electricity display	-	-	-
Operation control parameters	1	MAN	Switchover between auto and manual mode	-	○	○
	2	STby	Switchover between RUN and standby	○	○	○
	3	REM	Local/remote switchover	-	○	○
	4	PrG	Ramp soak control command	-	○	○
	5	AT	Auto-tuning run command	-	○	○
	6	LACH	Alarm output latch release command	-	○	○
	7	Svn	SV selection	-	○	○
	8	PLn1	PID selection	-	○	○
	9	AL1	ALM1 set value	-	○	○
	10	A1-L		-	○	○
	11	A1-H		-	○	○
	12	AL2	ALM2 set value	-	○	○
	13	A2-L		-	○	○
	14	A2-H		-	○	○
	15	AL3	ALM3 set value	-	○	○
	16	A3-L		-	○	○
	17	A3-H		-	○	○
	18	AL4	ALM4 set value	-	○	○
	19	A4-L		-	○	○
	20	A4-H		-	○	○
	21	AL5	ALM5 set value	-	○	○
	22	A5-L		-	○	○
	23	A5-H		-	○	○
27	WCMd	Electric power calculation command	-	○	○	
28	LoC	Key lock	-	○	○	
Ch1 PID Control parameters	50	P	Proportional band (%)	-	○	○
	51	i	Integration time	-	○	○
	52	d	Differential time	-	○	○
	53	hyS	ON/OFF control hysteresis	-	○	○
	54	CoL	Cooling proportional band coefficient	-	○	○
	55	db	Dead band (%)	-	○	○
	56	bAL	Output convergence value (%)	-	○	○
	57	Ar	Anti-reset windup	-	○	○
	58	rEv	Normal/reverse operations	-	○	○
	59	SvL	SV limit (lower)	-	○	○
	60	Svh	SV limit (upper)	-	○	○
	61	TC1	OUT1 proportional cycle	-	○	○
	62	TC2	OUT2 proportional cycle	-	○	○
	63	PLC1	OUT1 lower limit	-	○	○
	64	PhC1	OUT1 upper limit	-	○	○
	65	PLC2	OUT2 lower limit	-	○	○
	66	PhC2	OUT2 upper limit	-	○	○

○: Target of cooperative operation    ○: Target of copy

	Screen No.	Parameter		kykd: Cooperative operation items		Target of copy
		Display	Name	0	1	
Ch1 PID Control parameters	67	PCUT	Type of output limiter	-	○	○
	73	ALPA	Alpha	-	○	○
	74	bEtA	Beta	-	○	○
Ch2 PLT PID pallet Parameter	100	SV1	SV1	-	○	○
	101	P1	Proportional band 1 (%)	-	○	○
	102	i1	Integration time 1	-	○	○
	103	d1	Differential time 1	-	○	○
	104	HyS1	ON/OFF control hysteresis 1	-	○	○
	105	CoL1	Cooling proportional band 1 (%)	-	○	○
	106	db1	Dead band 1 (%)	-	○	○
	107	bAL1	Output convergence value 1 (%)	-	○	○
	108	AR1	Anti-reset windup 1	-	○	○
	109	REV1	Normal/reverse 1	-	○	○
	to	to		-	○	○
	160	SV7	SV 7	-	○	○
	161	P7	Proportional band 7 (%)	-	○	○
	162	i7	Integration time 7	-	○	○
	163	d7	Differential time 7	-	○	○
	164	HyS7	ON/OFF control hysteresis 7	-	○	○
	165	CoL7	Cooling proportional band 7 (%)	-	○	○
	166	db7	Dead band 7 (%)	-	○	○
	167	bAL7	Output convergence value 7 (%)	-	○	○
	168	AR7	Anti-reset windup 7	-	○	○
	169	REV7	Normal/reverse 7	-	○	○
	170	REF1	PID switching point 1	-	○	○
	171	REF2	PID switching point 2	-	○	○
	172	REF3	PID switching point 3	-	○	○
	173	REF4	PID switching point 4	-	○	○
	174	REF5	PID switching point 5	-	○	○
	175	REF6	PID switching point 6	-	○	○
	176	REF7	PID switching point 7	-	○	○
	177	SVMX	Max SV selection number	-	○	○
	178	PL1M	Max PID selection number	-	○	○
	200	PtN	Ramp soak operation pattern (Step No.)	-	○	○
	201	tiMU	Ramp soak time units	-	○	○
	202	SV-1	Ramp soak seg 1 SV 1	-	○	○
203	tM1R	Ramp soak seg 1 ramp time	-	○	○	
204	tM1S	Ramp soak seg 1 soak time	-	○	○	
:	:		-	○	○	
391	SV64	Ramp soak seg 64 SV 64	-	○	○	
392	t64R	Ramp soak seg 64 ramp time	-	○	○	
Ch3 PRG Ramp/soak Parameter	393	t64S	Ramp soak seg 64 soak time	-	○	○
	394	Mod	Ramp soak mode	-	○	○
	395	GSoK	Guaranty soak ON/OFF	-	○	○
	396	GS-L	Guaranty soak band (Lower)	-	○	○

○: Target of cooperative operation    ○: Target of copy

	Screen No.	Parameter		kykd: Cooperative operation items		Target of copy
		Display	Name	0	1	
Ch3 PRG Ramp/soak Parameter	397	GS-H	Guaranty soak band (Upper)	-	○	○
	398	PVSt	PV start	-	○	○
	399	CoNt	Restore mode	-	○	○
	400	PtNM	Max pattern selection	-	○	○
	401	PMiN	Min pattern selection	-	○	○
Ch4 MoN Monitor parameters	420	StAt	Ramp soak progress	-	-	-
	421	MV1	MV1 (%)	-	-	-
	422	MV2	MV2 (%)	-	-	-
	423	PFb	PFB input value (%)	-	-	-
	424	RSV	RSV1 input value	-	-	-
	425	Ct1	Heater current 1 (A)	-	-	-
	427	LC1	SSR leak current 1 (A)	-	-	-
	429	tM1	Remaining time on timer 1	-	-	-
	430	tM2	Remaining time on timer 2	-	-	-
	431	tM3	Remaining time on timer 3	-	-	-
	432	tM4	Remaining time on timer 4	-	-	-
	433	tM5	Remaining time on timer 5	-	-	-
	435	CoMM	Communication status	-	-	-
	436	CUR1	Current 1	-	-	-
	438	PoW	Electric power	-	-	-
	439	KWH	Power	-	-	-
	440	RCN1	Number of operating times	-	-	-
	441	RCN2	Number of operating times	-	-	-
	442	RUNt	Operating days	-	-	-
	443	FALt	Error source	-	-	-
444	di	DI input state	-	-	-	
445	ERSt	Communication error station number	-	-	-	
446	PLNo	Current PID No.	-	-	-	
447	PtNo	Current pattern No.	-	-	-	
Ch5 ALM Alarm parameters	470	A1tP	ALM1 alarm type	-	○	○
	471	A1Hy	ALM1 hysteresis	-	○	○
	472	dLy1	ALM1 delay	-	○	○
	473	dL1U	ALM1 delay time units	-	○	○
	474	AoP1	ALM1 option	-	○	○
	475	A2tP	ALM2 alarm type	-	○	○
	476	A2Hy	ALM2 hysteresis	-	○	○
	477	dLy2	ALM2 delay	-	○	○
	478	dL2U	ALM2 delay time unit	-	○	○
	479	AoP2	ALM2 option	-	○	○
	480	A3tP	ALM3 alarm type	-	○	○
	481	A3Hy	ALM3 hysteresis	-	○	○
	482	dLy3	ALM3 delay	-	○	○
	483	dL3U	ALM3 delay time unit	-	○	○
	484	AoP3	ALM3 option	-	○	○
	485	A4tP	ALM4 alarm type	-	○	○

○: Target of cooperative operation    ○: Target of copy

	Screen No.	Parameter		kykd: Cooperative operation items		Target of copy
		Display	Name	0	1	
Ch5 ALM Alarm parameters	486	A4Hy	ALM4 hysteresis	-	○	○
	487	dLy4	ALM4 delay	-	○	○
	488	dL4U	ALM4 delay time units	-	○	○
	489	AoP4	ALM4 option	-	○	○
	490	A5tP	ALM5 alarm type	-	○	○
	491	A5Hy	ALM5 hysteresis	-	○	○
	492	dLy5	ALM5 delay	-	○	○
	493	dL5U	ALM5 delay time units	-	○	○
	494	AoP5	ALM5 option	-	○	○
	500	Hb1	HB alarm set value (for CT)	-	○	○
	501	Hb1H	HB alarm hysteresis (for CT)	-	○	○
	502	HS1	Shorted-load alarm set value (for CT)	-	○	○
	503	HS1H	Shorted-load alarm hysteresis (for CT)	-	○	○
	508	LbtM	Loop break detection time	-	○	○
	509	LbAb	Loop break detection range (°C)	-	○	○
511	WHAL	Electricity alarm	-	○	○	
Ch6 Set Setup Parameter	530	PVt	PV input type	-	○	○
	531	PVb	PV input lower limit	-	○	○
	532	PVF	PV input upper limit	-	○	○
	533	PVd	Decimal point position	-	○	○
	535	Cut	Square-root extractor cut point	-	○	○
	536	PVoF	PV input shift	-	○	○
	537	SVoF	SV shift	-	○	○
	538	tF	PV input filter	-	○	○
	539	AdJ0	PV display zero adjustment	-	○	○
	540	AdJS	PV display span adjustment	-	○	○
	541	RCJ	Cold junction compensation	-	○	○
	543	REM0	Remote SV zero adjustment	-	○	○
	544	REMS	Remote SV span adjustment	-	○	○
	545	REMR	Remote SV input range	-	○	○
	546	RtF	Remote SV input filter	-	○	○
	547	C1R	OUT1 range	-	○	○
	548	C2R	OUT2 range	-	○	○
	549	FLo1	MV1 during FALT	-	○	○
	550	FLo2	MV2 during FALT	-	○	○
	551	SFo1	MV1 during Soft Start	-	○	○
	553	SFtM	Soft Start set time	-	○	○
	554	Sbo1	MV1 during standby	-	○	○
	555	Sbo2	MV2 during standby	-	○	○
	556	SbMd	Standby mode	-	○	○
	557	Aot	AO output type	-	○	○
558	AoL	AO lower scaling	-	○	○	
559	AoH	AO upper scaling	-	○	○	
561	VoLt	Fixed voltage value	-	○	○	
562	CUR	Current value for simple power calculation	-	○	○	

○: Target of cooperative operation    ○: Target of copy

	Screen No.	Parameter		kykd: Cooperative operation items		Target of copy
		Display	Name	0	1	
Ch6 Set Setup Parameter	563	iMiN	Truncation point before power calculation	-	○	○
	564	WdP	Decimal point position for electric power	-	○	○
	565	PHy	Power factor for simple calculation	-	○	○
	566	RyCN	Upper limit of relay contact operation	-	○	○
	567	oPtM	Upper limit of operation days	-	○	○
Ch7 SYS System Parameter	590	UKy1	USER key	-	○	○
	591	UKy2	USER + UP key	-	○	○
	592	UKy3	USER + DOWN key	-	○	○
	593	di1	DI-1 function	-	○	○
	594	di2	DI-2 function	-	○	○
	595	di3	DI-3 function	-	○	○
	596	di4	DI-4 function	-	○	○
	597	di5	DI-5 function	-	○	○
	599	oU1t	DO1 output type	-	○	○
	600	oU2t	DO2 output type	-	○	○
	601	do1t	DO1 output type	-	○	○
	602	do2t	DO2 output type	-	○	○
	603	do3t	DO3 output type	-	○	○
	604	do4t	DO4 output type	-	○	○
	605	do5t	DO5 output type	-	○	○
	607	LoU1	LED indicator assignment (OUT1)	-	○	○
	608	LoU2	LED indicator assignment (OUT2)	-	○	○
	609	LEV1	LED indicator assignment (Ev1)	-	○	○
	610	LEV2	LED indicator assignment (Ev2)	-	○	○
	611	LEV3	LED indicator assignment (Ev3)	-	○	○
	612	LEV4	LED indicator assignment (Ev4)	-	○	○
	613	LEV5	LED indicator assignment (Ev5)	-	○	○
	614	LEV6	LED indicator assignment (Ev6)	-	○	○
	615	LStb	LED indicator assignment (STBY)	-	○	○
	616	LMAN	LED indicator assignment (MANU)	-	○	○
	617	RMP	Ramp SV ON/OFF	-	○	○
	618	RMPL	Ramp SV decline	-	○	○
	619	RMPH	Ramp SV incline	-	○	○
	620	RMPU	Ramp SV slope time unit	-	○	○
	621	SVt	Ramp SV display mode	-	○	○
	622	CtRL	Control method	-	○	○
623	PRCS	Control target	-	○	○	
624	oNoF	ONOFF hysteresis	-	○	○	
625	SLFb	PV stable width during self tuning	-	○	○	
626	StMd	Start mode	-	○	○	
627	dt	Control operation cycle	-	○	○	
628	PLtS	PID palette switching method	-	○	○	

○: Target of cooperative operation    ○: Target of copy

	Screen No.	Parameter		kykd: Cooperative operation items		Target of copy
		Display	Name	0	1	
Ch8 MATH Calculation function Parameter	650	MAtH	Simple calculation ON/OFF	-	○	○
	651	W1MA	Wafer 1 calculation	-	○	○
	652	W1i1	Wafer 1 input 1	-	○	○
	653	W1i2	Wafer 1 input 2	-	○	○
	654	W1i3	Wafer 1 input 3	-	○	○
	655	W1o1	Simple calculation result wafer 1 output 1	-	-	-
	656	W1o2	Simple calculation result wafer 1 output 2	-	-	-
	657	W1o3	Simple calculation result wafer 1 output 3	-	-	-
	658	W1o4	Simple calculation result wafer 1 output 4	-	-	-
	:	:		-	-	-
	723	WAMA	Wafer 10 calculation	-	○	○
	724	WAI1	Wafer 10 input 1	-	○	○
	725	WAI2	Wafer 10 input 2	-	○	○
	726	WAI3	Wafer 10 input 3	-	○	○
	727	WA01	Simple calculation result wafer 10 output 1	-	-	-
	728	WA02	Simple calculation result wafer 10 output 2	-	-	-
	729	WA03	Simple calculation result wafer 10 output 3	-	-	-
	730	WA04	Simple calculation result wafer 10 output 4	-	-	-
	731	CoN1	Constant 1	-	○	○
	:	:		-	○	○
740	CoNA	Constant 10	-	○	○	
CH9 CoM Communication parameters	760	CtyP	Communication type	-	○	○
	761	StNo	Station No.	-	-	-
	762	SPEd	RS-485 baud rate	-	○	○
	763	PRty	RS-485 parity	-	○	○
	764	iNtV	RS-485 response interval	-	○	○
	765	RVWt	RS-485 receive timeout	-	○	○
	766	RVct	RS-485 send retry times	-	○	○
	767	SCC	Communication permissions	-	○	○
	768	MXSt	Max. station number	-	○	○
	769	UA01	MODBUS user address setting 1	-	○	○
	:	:		-	○	○
	800	UA32	MODBUS user address setting 32	-	○	○
	801	CSVG	Communication SV gain	-	○	○
	802	CSVS	Communication SV shift	-	○	○
	803	KYKd	Cooperative operation items	-	-	-
	804	APCY	All parameters copy	-	-	-
	805	PLST	Target PLC station No.	-	○	○
	806	PAcK	PLC registration number allocation rule	-	○	○
	807	MSWT	Communication interval among stations	-	○	○
	808	PLWt	Communication interval between station and PLC	-	○	○
809	PLAD	Starting register number in programless communication	-	○	○	

○: Target of cooperative operation    ○: Target of copy

	Screen No.	Parameter		kykd: Cooperative operation items		Target of copy
		Display	Name	0	1	
CH9 CoM Communication parameters	810	SA01	MODBUS address 1 for the setting area	-	○	○
	:	:		-	○	○
	825	SA16	MODBUS address 16 for the setting area	-	○	○
	826	MA01	MODBUS address 1 for the monitor area	-	○	○
	:	:		-	○	○
	841	MA16	MODBUS address 16 for the monitor area	-	○	○
Ch10 PFB PFB parameters	870	PGAP	PFB dead band	-	○	○
	871	tRVL	Valve stroke time	-	○	○
	873	CAL	PFB input adjustment	-	-	-
Ch11 DSP DSP parameters	-	dP01	Parameter mask	-	○	○
	-	dP02		-	○	○
	:	:		-	○	○
	-	dP31		-	○	○
Ch12 CFG Configuration Parameter	940	toUt	time until the display returns to PV/SV screen from setting screen.	-	○	○
	942	SoFK	Blinking SV during Soft Start	-	○	○
	943	ALMF	Blinking PV/SV at ALM	-	○	○
	944	LoFF	Operation timeout	-	○	○
	945	dSPt	PV/SV Display off	-	○	○
	946	FLtF	Blinking PV at input error	-	○	○
	947	bLit	Brightness	-	○	○
	948	bCoN	Control at burnout	-	○	○
	949	dMod	Display mode switchover	-	○	○
	950	PL01	Model code	-	-	-
	:	:		-	-	-
	962	PL13		-	-	-
	963	RSt	Reset	-	-	-
	965	VER1	Software version (fixed data)	-	-	-
966	VER2	-		-	-	
967	VER3	-		-	-	
968	VER4	-		-	-	
Ch13 PASS Password Parameter	990	PAS1	Password1 setup	-	○	○
	991	PAS2	Password2 setup	-	○	○
	992	PAS3	Password3 setup	-	○	○

# Chapter 10

## Programless communication

Overview – 82



Connection – 83



Programless communication – 84



Setup and related parameters – 88



Setup for Programless Communication – 90



# Overview

Programmable controller (PLC) can read the data of temperature controllers or write data on temperature controllers without preparing a rudder program. One PLC acts as a master, and multiple temperature controllers act as slaves. Each temperature controller in turn carries out master-slave communication with PLC. The communication protocol is MODBUS RTU.

## System configuration

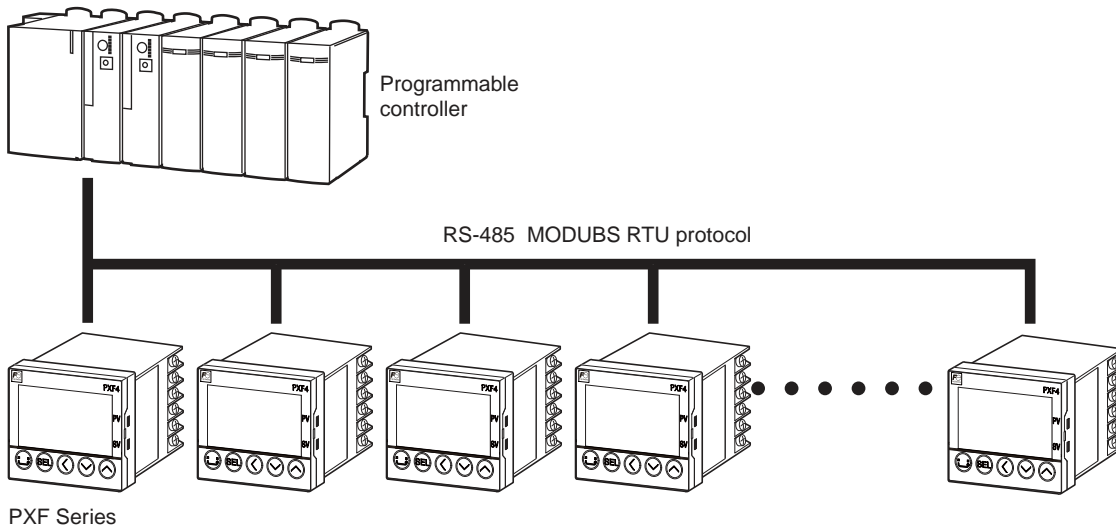

Maximum 31 units can be connected

# Connection

To connect PLC and temperature controllers, follow the instructions for RS-485 connection on page 11.

The following PLC interface units are supported:

## Mitsubishi MELSEC-Q series

### ■ MODBUS interface unit

Name: Q-supported MODBUS interface unit

Model: QJ71MB91

## Siemens S7-300CPU series

### ■ RS-485 interface unit + MODBUS slave dongle

(Both are required for MODBUS communication.)

Name: RS-485 interface unit

Model: CP341

Name: MODBUS slave dongle

Model: 6ES7870-1AB01-0YA0

# Programless communication

A temperature controller PXF acts as a master for communication between PLC and temperature controller, and read/write the MODBUS address of PLC according to the programless communication setting.

(A PLC does not require a rudder program for communication because the temperature controller automatically update the data of the PLC's MODBUS address.)

Communication protocol used is MODBUS RTU.

First, the temperature controller of the station No.1 functions as a master to communicate with PLC. Then, the temperature controller of the next station number becomes a master and communicates with PLC. The same steps are repeated until all the temperature controllers finish communication, and then restart communication from the temperature controller of the station No. 1.

In programless communication, each temperature controller reads setting data from the addresses in the setting area allocated to the MODBUS communication field of PLC.

Then, each temperature controller writes monitor values of them onto addresses of PLC monitor area. (fixed to 20 words for both the setting area and the monitor area.)

Example: allocating MODBUS address of PLC starting from 41001

PLC MODBUS communication address

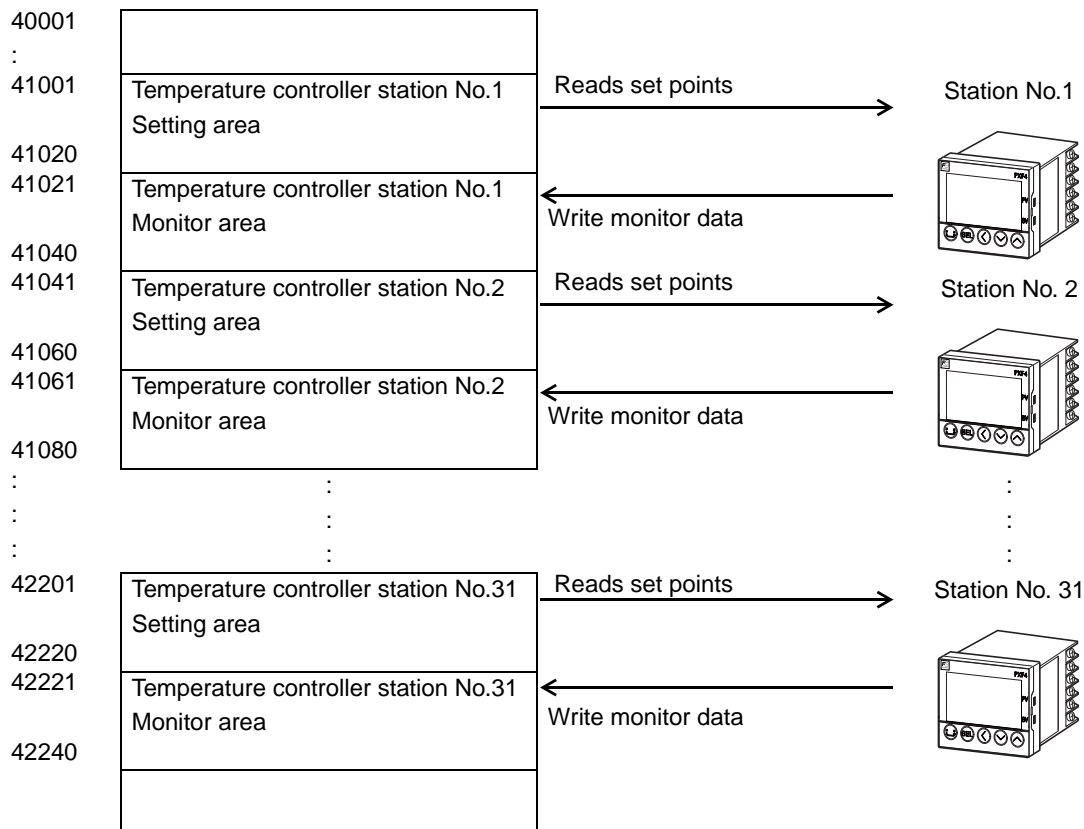

## Usage of MODBUS communication address of PLC

The following setting area and monitor area are required for programless communication between PLC and temperature controller.

4XXXX	+0	Setting area (20 words)	System field	Read demand flag (1 word)
	+1			Parameter setting demand flag (1 word)
	+2			Command setting demand flag (1 word)
	+3			Command (1 word)
	+4		Data field	Setting parameter (16 words)
	:			
	+19			
	+20	Monitor area (20 words)	System field	Read response flag (1 word)
	+21			Parameter setting response flag (1 word)
	+22			Command setting demand flag (1 word)
	+23			Data on read error and setting error (1 word)
	+24		Data field	Monitor parameter (16 words)
	:			
	+39			

## Setting area

The setting area enables PLC to change the set points of temperature controllers, or control temperature controllers.

- Setting area data field  
Data field of setting area enables PLC to change the set points of up to 16 parameters of temperature controllers.
- Setting area system field  
Setting a "demand flag" for system field enables PLC to request PUM to change configuration, readout data , etc.

Item	Value	Command	Action
Read demand flag	0000h	Stop operation	Does not update the data field of monitor area
	0001h	Read once	Read the data of temperature controller and update the monitor area data field once.
	0002h	Continuous read	Read the data of temperature controller and update the monitor area data field at every communication.
	0003h	Read SV	Read the parameter values registered in the setting area data field, and reflect them to the monitor area data field.
Parameter setting demand flag	0000h	Stop operation	Stops the data write demand on a temperature controller.
	0001h	Set once	Write the values set in the setting area data field onto a temperature controller once.
	0002h	Continuous setting	Write the values set in the setting area data field onto a temperature controller at every communication.
Command setting demand flag	0000h	Stop operation	Stops executing commands of the setting area.
	0001h	Perform once	Carries out a command of the setting area once.
Command	Refer to the command definition	Refer to the command definition	Carries out the command.

- Commands of the setting area system field

The following operation command codes can be set for each command.

Operation command	Operation command code	Switching
Auto/manual switchover	100	Auto mode
	101	Manual mode
RUN/standby	200	RUN
	201	Standby
Local SV/remote SV switchover	300	Local SV
	301	Remote SV
Ramp/soak control	400	Stop
	401	Run
	402	Hold
AT run/stop	500	AT stop
	501	Normal AT run
	502	Low-PV type AT run
Unlatch alarms	600	Unlatch all alarms
	601	Unlatch alarm 1
	602	Unlatch alarm 2
	603	Unlatch alarm 3
	604	Unlatch alarm 4
	605	Unlatch alarm 5
SV number change	700	to local SV
	701	to SV 1
	702	to SV 2
	703	to SV 3
	704	to SV 4
	705	to SV 5
	706	to SV 6
	707	to SV 7
PID number change	800	to local PID
	801	to PID 1 (PID group No.1)
	802	to PID 2 (PID group No.2)
	803	to PID 3 (PID group No.3)
	804	to PID 4 (PID group No.4)
	805	to PID 5 (PID group No.5)
	806	to PID 6 (PID group No.6)
	807	to PID 7 (PID group No.7)
Power calculation	900	Stop
	901	Run
	902	Hold
SV write mode	1000	Write mode of non-volatile memory
	1001	RAM write mode (Write data is initialized when the power is turned off.)
RAM data storage	1100	Stores RAM data in the non-volatile memory

## Monitor area

Allows you to check the response of temperature controllers to the response demand issued by the setting area system field of PLC, or the temperature controller status.

- **Monitor area data field**  
Data field of monitor area enables PLC to check the values of up to 16 parameters of temperature controllers.
- **Monitor area system field**  
Allows you to check the response of temperature controllers to the response demand issued by the setting area system field of PLC, or the temperature controller status.

Item	Value	Response	Action
Read response flag	0000h to 0003h	Normal response	Indicates that the response value agrees with the value of the read demand flag, and the response for demand is normal.
	8001h to 8003h	Error response	Indicates that the response for demand is erroneous. (i.e., read register data is erroneous.)
Parameter setting response flag	0000h to 0002h	Normal response	Indicates that the response value agrees with the value of the parameter setting demand flag, and the response for demand is normal.
	8001h to 8002h	Error response	Indicates that the response for demand is erroneous. (i.e., setting register data is erroneous.)
Command setting response flag	0000h to 0001h	Normal response	Indicates that the response value agrees with the value of the command demand flag, and the response for demand is normal.
	8001h	Error response	Indicates that the response for command demand is erroneous. (i.e., an error occurred during command execution.)
Data on read error and setting error	Data on read error (1 byte)		Shows error information in bits. (Refer to the below table for the detail.)
	Data on setting error (1 byte)		Shows error information in bits. (Refer to the below table for the detail.)

- **Data on read error and setting error for the monitor area system field**

Bit	Value	Error detail
1	0: no error 1: invalid address	The address for an unavailable register number is specified.
2	0: no error 1: limit error	Register data is out of the setting range.
3	0: no error 1: EPPROM busy	EPPROM is busy.

## Setup and related parameters

The following parameters need to be configured to use the programless communication.

In the programless communication, the station No. 1 acts as a master which requires more detailed setup than slave devices.

- Setup items only for master

Parameter channel	Screen No.	Parameter display symbol	Name	Setting range	Initial value	Remarks
CH9 CoM	765	RVWt	RS-485 receive timeout (set point x 10 ms)	1 to 100	10	
	766	RVCt	RS-485 send retry times	0 to 10	3	
	768	MXSt	Last station No.	0 to 31	0	Set the station number of the last controller.
	805	PLSt	Target PLC station No.	0 to 255	0	Set the station number of PLC. (Be sure not to assign the same station number with temperature controllers.)
	806	PAdk	PLC registration number allocation rule	0: contiguous allocation 1: individual allocation	0	Define how the PLC's MODBUS address areas for temperature controllers are allocated.
	807	MSWt	Communication interval between temperature controllers	0 - 100 (0 to 100 ms)	20	
	808	PLWt	Communication interval between a PLC and temperature controllers	0 - 100 (0 to 200 ms)	10	

- Setup items common for master and slaves

Parameter channel	Screen No.	Parameter display symbol	Name	Setting range	Initial value	Remarks	
CH9 CoM	760	CtYP	Communication type	0: MODBUS RTU 1: Cooperative operation 2: Programless communication	0	Select "2: Programless communication".	
	761	StNo	Station No.	0 to 255 (0: unresponsive communication)	1	Set "1" for the master. Set the station number starting from No.1. (Do not skip any numbers.)	
	762	SPEd	RS-485 baud rate	96: 9600 bps 192: 19200 bps 384: 38400 bps 115K: 115 Kbps	96	Set the baud rate.	
	763	PrTy	RS-485 parity	NoNE (no parity) odd EVEN	odd	Set the parity.	
	809	PLAd	Head of PLC registration numbers	0000 - FFFF	0	Set the first address for PLC's MODBUS communication area used in programless communication. When PAdK setting is individual allocation, configure this parameter on each device.	
	810	SA01	Modbus address of data No.1 in setting area	0 - 49999 (0: undefined, 40001 to 49999: MODBUS address)	0	Register the MODBUS address of the temperature controller you want to change the setting via PLC.	
	:						
	825	SA16	Modbus address of data No.16 in setting area	0 - 49999 (0: undefined, 40001 to 49999: MODBUS address)	0	Register the MODBUS address of the temperature controller you want to change the setting via PLC.	
	826	MA01	Modbus address of data No.1 in monitor area	0 - 49999 (0: undefined, 30001 to 39999, 40001 to 49999: MODBUS address)	0	Register the MODBUS address of the temperature controller you want to monitor via PLC.	
	:						
841	MA16	Modbus address of data No.16 in monitor area	0 - 49999 (0: undefined, 30001 to 39999, 40001 to 49999: MODBUS address)	0	Register the MODBUS address of the temperature co		

To check the communication status, use the following parameter.

- Parameter

Parameter channel	Screen No.	Parameter display symbol	Name	Setting range	Initial value	Remarks
CH4 MoN	445	ERSt	Communication error station number	Shows the station number under a cooperative communication error or a programless communication error.	-	If communication error occurs in several devices, the display shows their station numbers in turn for 2 seconds each.



# Setup for Programless Communication

## Setup for Mitsubishi PLC

### Programless communication with Mitsubishi PLC

Modbus communication enables programless communication with Mitsubishi PLC.  
In programless communication, PLC acts as a Modbus slave which receives data from each temperature controller.

Mitsubishi Modbus slave communication module is required.

### Required software and hardware

Hardware	Mitsubishi PLC CPU PLC power supply Modbus slave communication module PLC loader cable Setup PC
Software	Mitsubishi PLC loader software GX Works2

### Allocation of Modbus register for PLC programless communication

Each temperature controller accesses the PLC by using Modbus 03H and 10H functions.

Mitsubishi PLC does not have limit for the use of Modbus holding register. You can use both sequential allocation and individual allocation for allocating Modbus registers to 31 PXFs.

### Preparation for Mitsubishi PLC setup

This section describes the preparation and setup procedure for Mitsubishi PLC with the following configuration as an example.

Example:

Hardware and software:

PLC	: Q02CPU
PLC power supply	: Q61P
Modbus communication unit	: QJ71MB91
Temperature controller PXF	: 31 units
PLC setup software	: GX Works2 V1.525X

Communication conditions:

Communication speed	: 38400bps
Parity	: odd
Stop bit	: 1 bit
PLC station number	: 200

PLC register allocation rule : sequential allocation, start address of register: 0

Preparation:

1. Define the register number for programless communication and the allocation method.
2. Configure the hardware environment with PLC's CPU, power supply, and communication unit.
3. Install the setup software GX Works2 by using the setup PC.  
(Refer to the instructions for GX Works2 for the installation procedure.)
4. Connect the PC and the PLC with the PLC loader cable.

## Mitsubishi PLC setup

### 1 Creating a new project

1. Select the CPU series and model you use, and click OK.

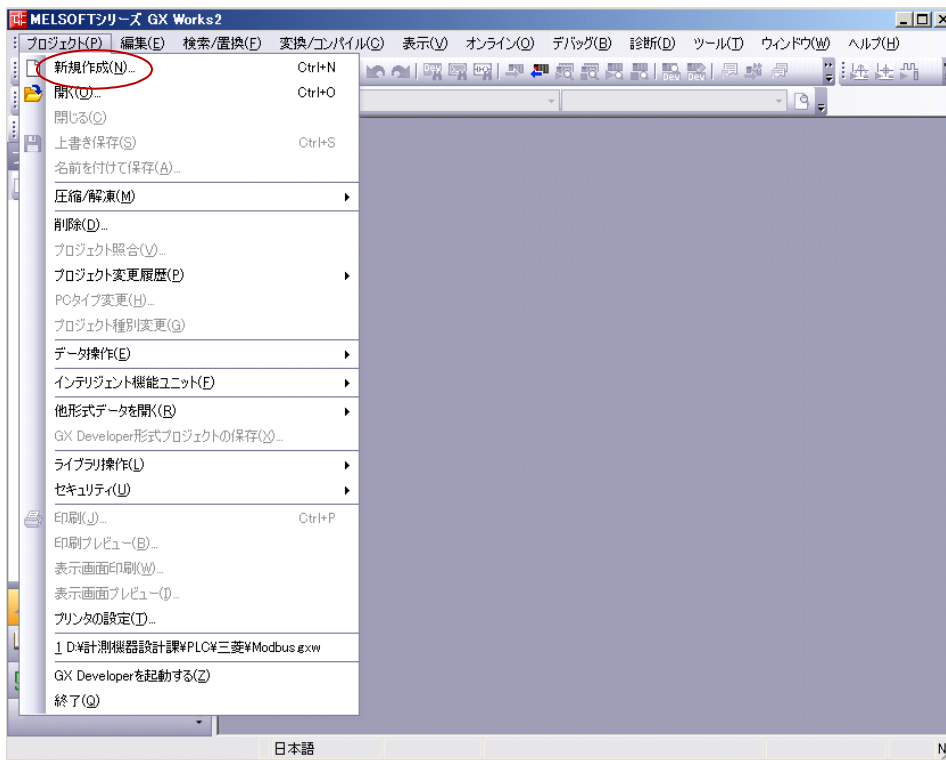

2. Select the CPU series and model you use, and click OK.

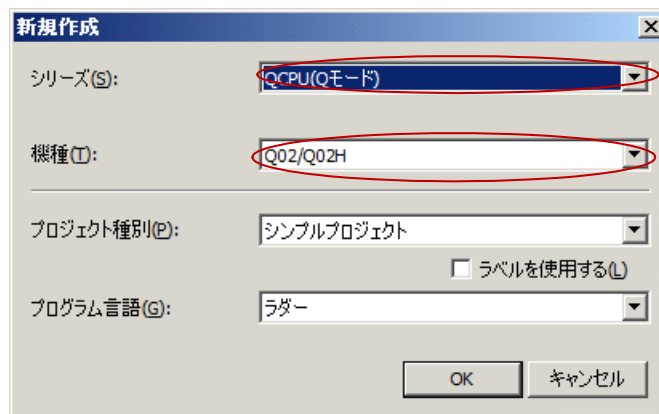

## 2 Adding intelligent functional module

1. Select Project > Intelligent Function Module > New Module.

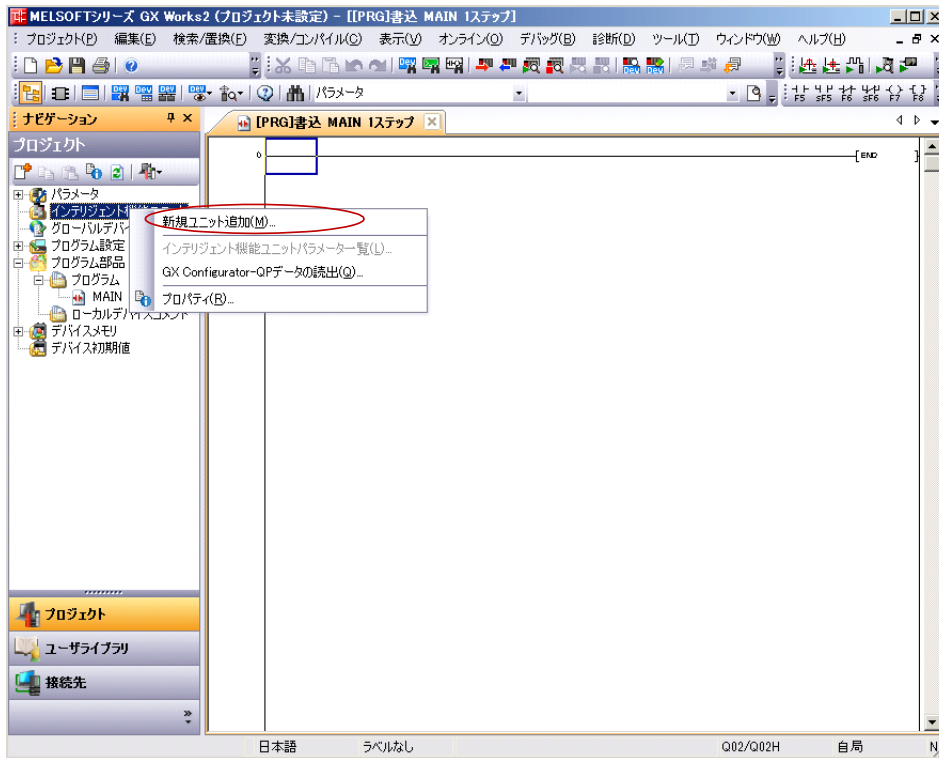

2. Set Module type, Module model, Mounted Slot No., Specify Start XY Address, and Title, and then click OK.

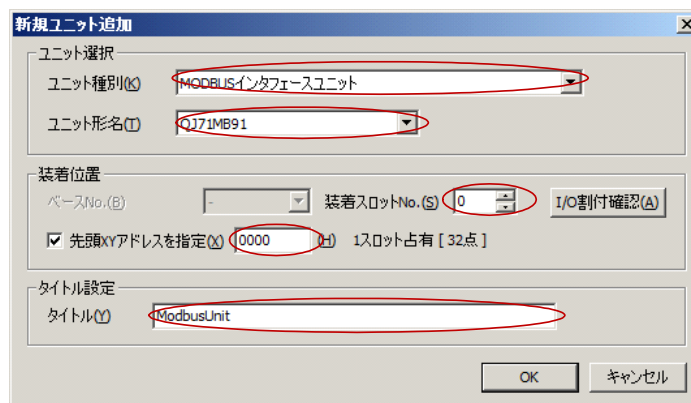

### 3 Setting communication conditions

1. Select Project > Intelligent Function Module > 0000QJ71MB9 > Switch setting.

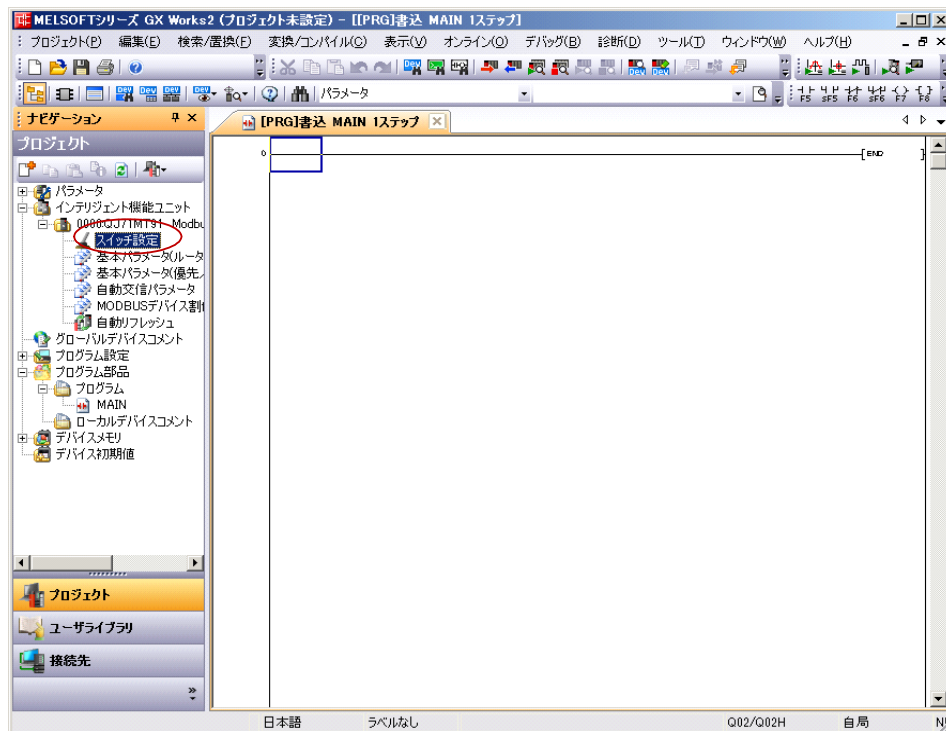

2. Enter the mode setting, transmission setting, communication speed for CH2, and station number setting for CH1/CH2, and then click OK.

Setting target: CH2 (for RS485 communication)

Mode setting : Select either master/slave function  
 MODBUS device assignment : Start with default parameters  
 (Note: If you assigned your device, select "Start with the user-set parameters".)  
 Data bit : 8  
 Parity bit presence : present  
 Even /odd parity : odd (in accordance with PXF)  
 Stop bit : 1  
 Frame mode : RTU mode  
 Online change : Enable  
 Baud rate : 38400bps (in accordance with PXF)  
 Station number : 200 (excluding 1-32)

スイッチ設定 0000-QJ71MB91

項目	CH1	CH2
モード設定	スレープ機能	スレープ機能
MODBUSデバイス割付 パラメータ起動方法	デフォルトパラメータで起動	-
データビット	8	8
パリティビットの有無	あり	あり
奇数/偶数パリティ	偶数	奇数
ストップビット	1	1
フレームモード	RTUモード	RTUモード
RUN中書き込み	禁止	許可
通信速度設定	通信速度設定	通信速度設定
	19200 bps	38400 bps
CH1/CH2局番設定	CH1/CH2局番設定	CH1/CH2局番設定
	201	200

※PCパラメータのスイッチ設定と本ダイアログの設定は連動しています。  
 PCパラメータのスイッチ設定に範囲外の値が設定されていた場合は、  
 本ダイアログではデフォルトの値を表示します。

OK キャンセル

## 4 Checking Modbus device assignment

1. Select Project > Intelligent Function Module > 0000QJ71MB91 > Modbus device assignment.

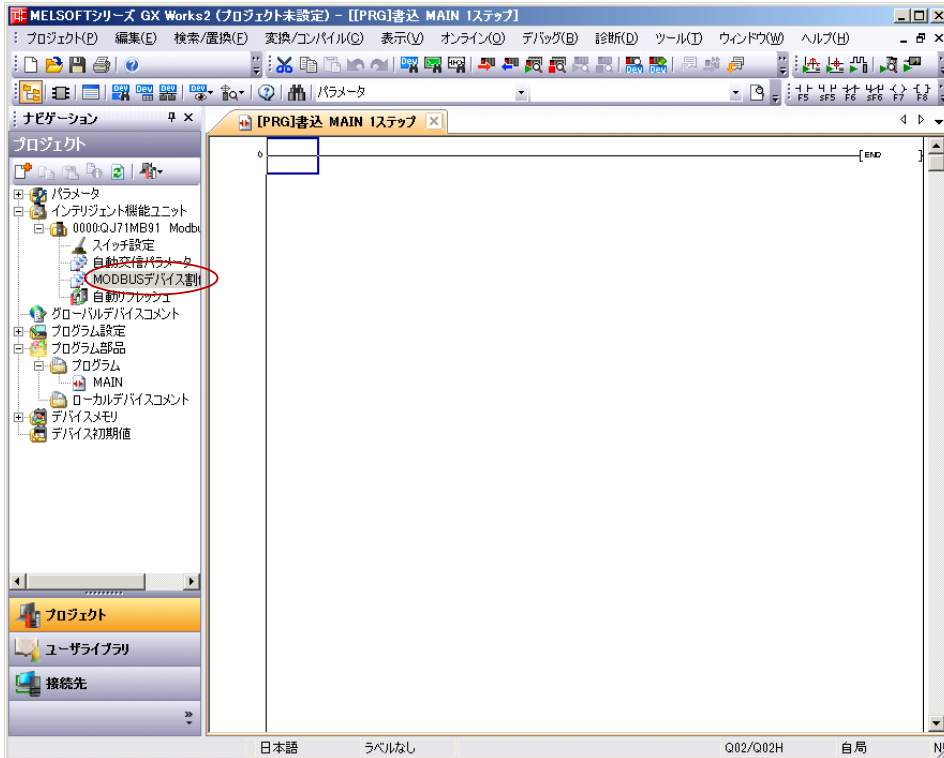

2. The register addresses for automatic MODBUS device assignment are shown as follows.

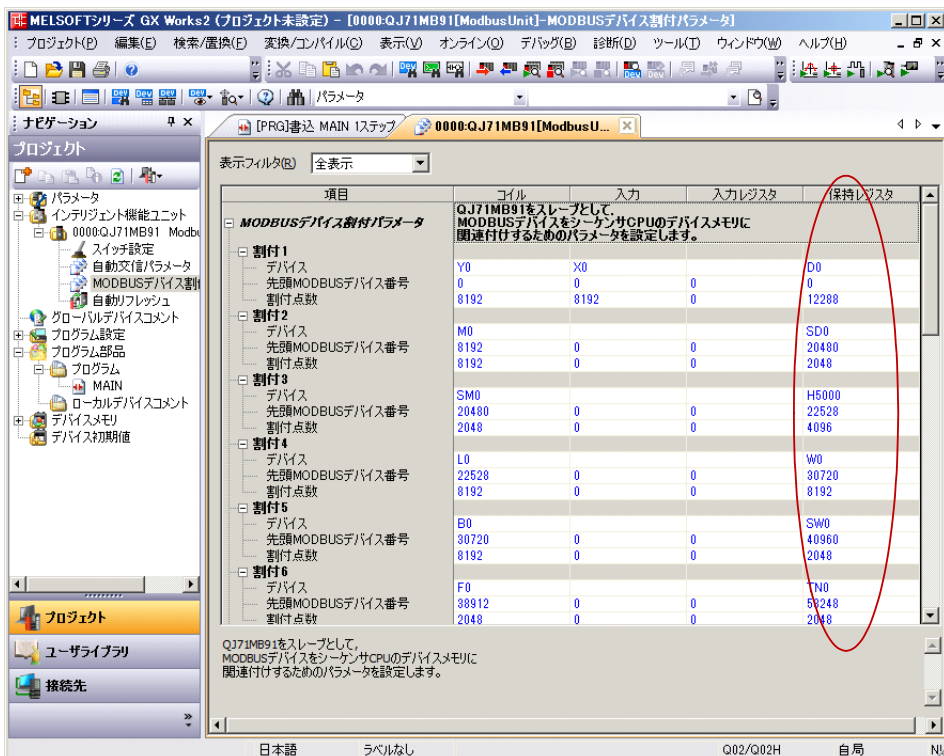

## 5 Writing to PLC

### 1. Select Online > Write to PLC.

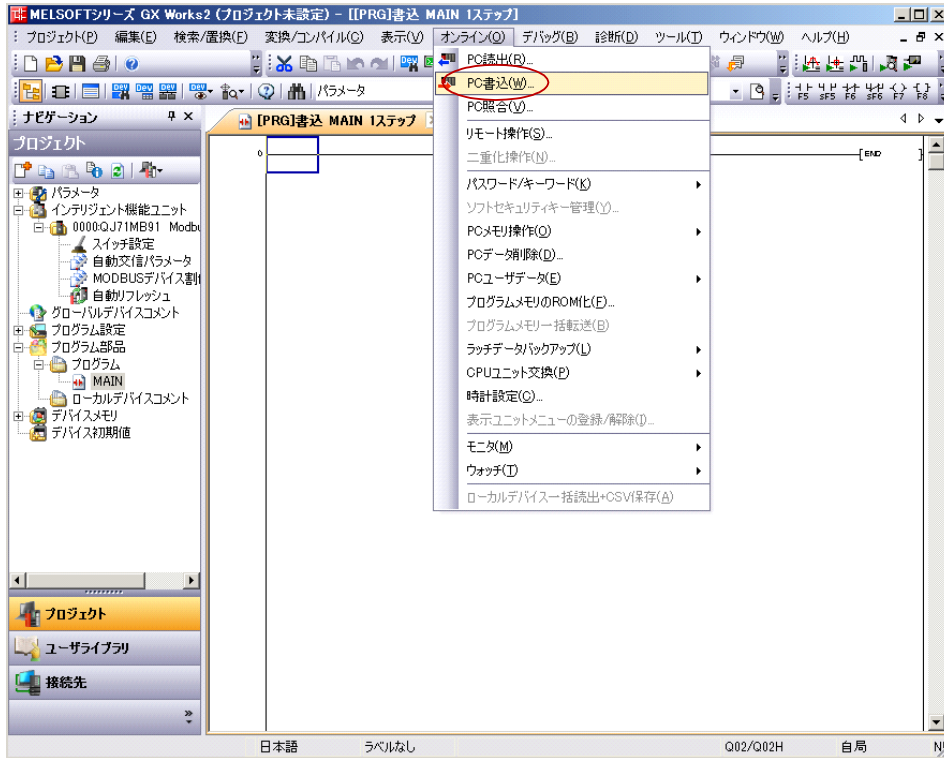

### 2. Select "Select All" and click Execute.





3. Click Yes.

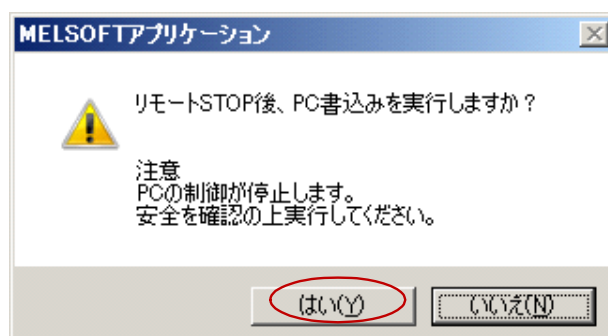

4. The progress dialog box is displayed. The message "Completed" is displayed when the writing is completed. Click Close.



5. Click OK to remotely operate PLC.

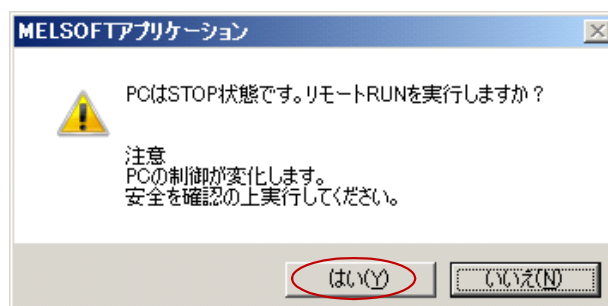



## Setup for Siemens PLC

### Programless communication with Siemens PLC

Modbus communication enables programless communication with Siemens PLC.

In programless communication, PLC acts as a Modbus slave which receives data from each temperature controller.

For Siemens PLC Modbus slave communication, RS-485 communication module (for example, CP341), and Modbus slave driver are required. The Modbus slave driver software and the dongle are available from Siemens AG.

### Required software and hardware

Hardware	Memory necessary for Siemens S7 series CPU and for Modbus communication driver PLC power supply RS485 communication module (for example, CP341) Dongle for Modbus slave communication Setup PC PLC loader cable PCI card for STEP 7
Software	Siemens SIMATIC STEP 7 Siemens SIMATIC PtP CP Loadable Drivers Configuration Package (Modbus driver and communication setup software for CP341 and CP441-2)

### Allocation of Modbus register for PLC programless communication

Each temperature controller accesses a PLC by using Modbus 03H and 10H functions.

The following is the definition of 03H and 10H function holding registers of Siemens PLC.

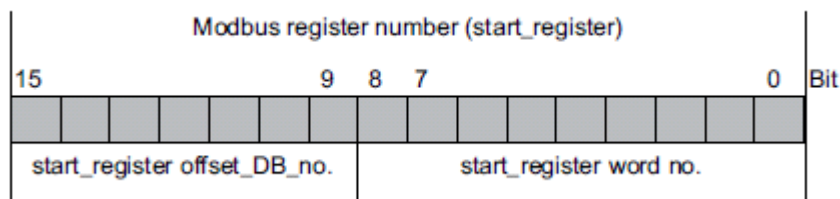

Offset DB number = DB number - Base DB number

(For the detail, refer to the instructions for Siemens Modbus slave.)

One data block can store 512 registers.

As the setting area and the monitor area for programless communication are composed of 40 words total, continuous allocation is available for up to 12 devices with one DB.

When using 12 units or more, select individual allocation.

## Preparation for Siemens PLC setup

This section describes the preparation and setup procedure for Siemens PLC with the following configuration as an example.

Example:

Hardware and software

PLC : CPU313C-2 DP  
 PLC power supply : PS307  
 Communication Module : CP341  
 Temperature controller PXF : 31 units  
 PLC setup software : SIMATIC STEP 7 V5.4  
 Modbus slave driver : SIMATIC PtP CP  
 Loadable Drivers  
 Configuration Package V1.0.3 for CP341, CP441-2

Communication conditions:

Baud rate : 38400 bps  
 Parity : odd  
 Stop bit : 1 bit  
 PLC station number : 255

Data block definition

Base block : DB400  
 PLC register allocation rule : individual allocation

PLC setting of each PXF and start address of monitor area

Station number	Start address	Station number	Start address	Station number	Start address
1	0	13	512	25	1024
2	40	14	552	26	1064
3	80	15	592	27	1104
4	120	16	632	28	1144
5	160	17	672	29	1184
6	200	18	712	30	1224
7	240	19	752	31	1264
8	280	20	792		
9	320	21	832		
10	360	22	872		
11	400	23	912		
12	440	24	952		

Preparation:

1. Define the register number for programless communication and the allocation method.
2. Attach the dongle on the back of the communication module CP341.
3. Configure the hardware environment with PLC's CPU, power supply, and communication module.
4. Install the setup software SIMATEC STEP 7 by using the setup PC.  
(Refer to the instructions for SIMATEC STEP7 for the installation procedure.)
5. Install the Modbus slave driver on the PC.  
(Refer to the instructions for the Modbus slave driver for the installation procedure.)
6. Connect the PC and the PLC with the PLC loader cable.

## Siemens PLC setup

### 1 Creating a S7 project

1. Double-click the SIMATIC Manager icon on the Windows desktop.
2. Select the File > Wizard "New Project" menu command.

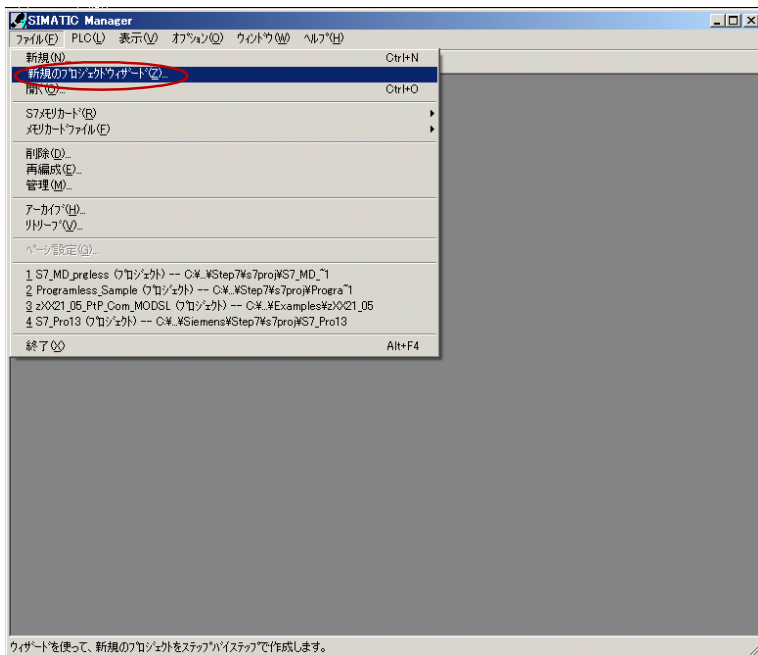

3. Click Next.



- Select the CPU type: CPU313C\_2 DP, and click Next.

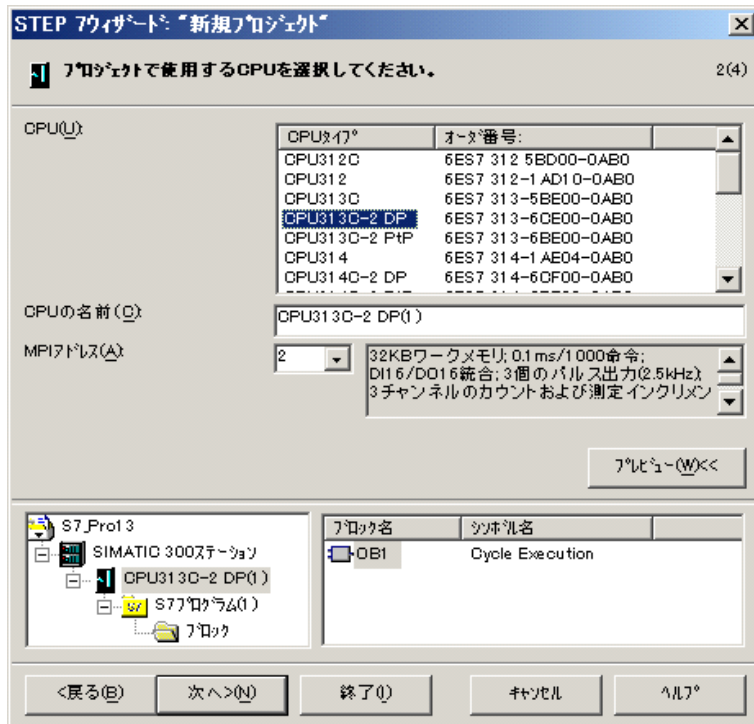

- Select the organization block: OB100 and Programming language: STL, and click Next.

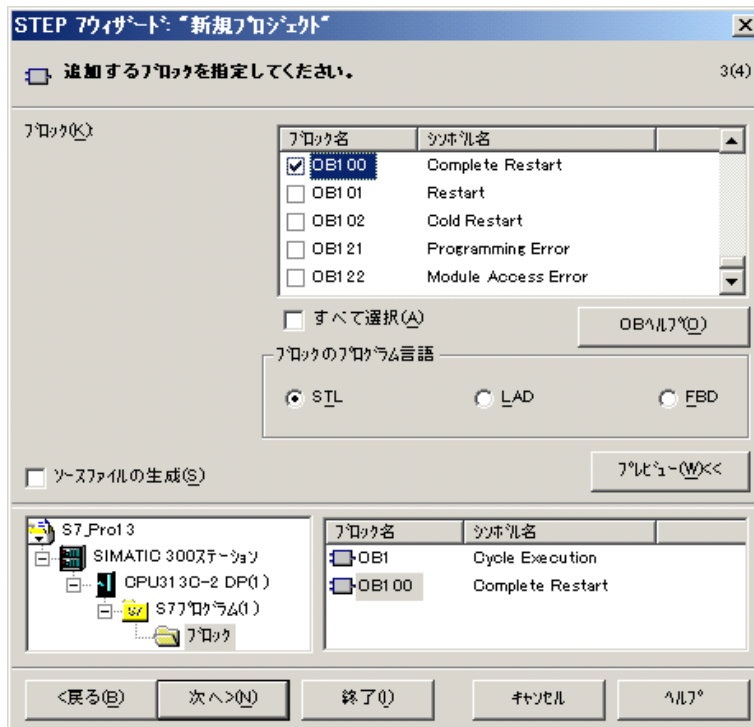

6. Enter a project name, and click Make.

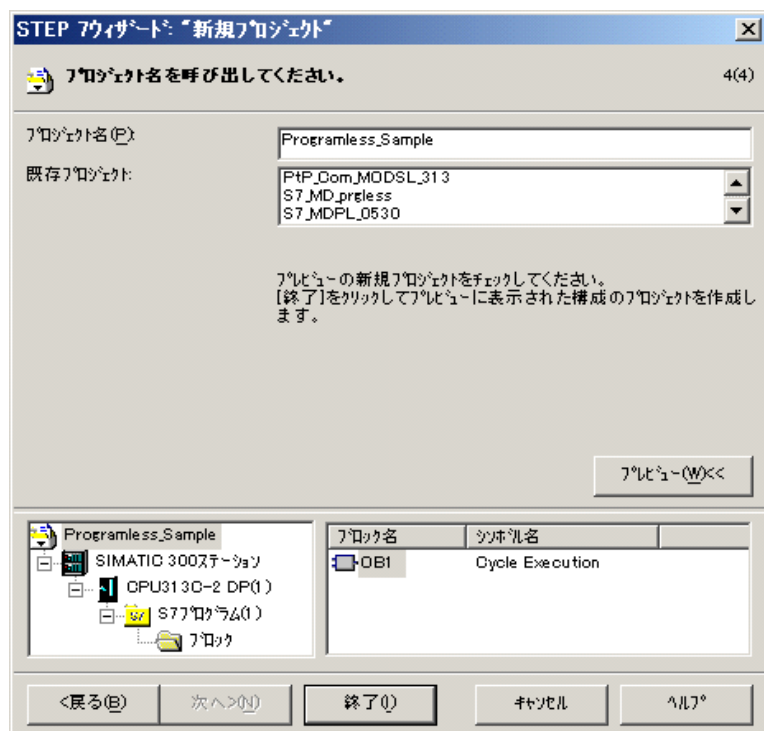

## 2 Configuring the Modbus slave communication module

1. Open the SIMATIC 300 Station folder and double-click the Hardware symbol on the right-hand pane.

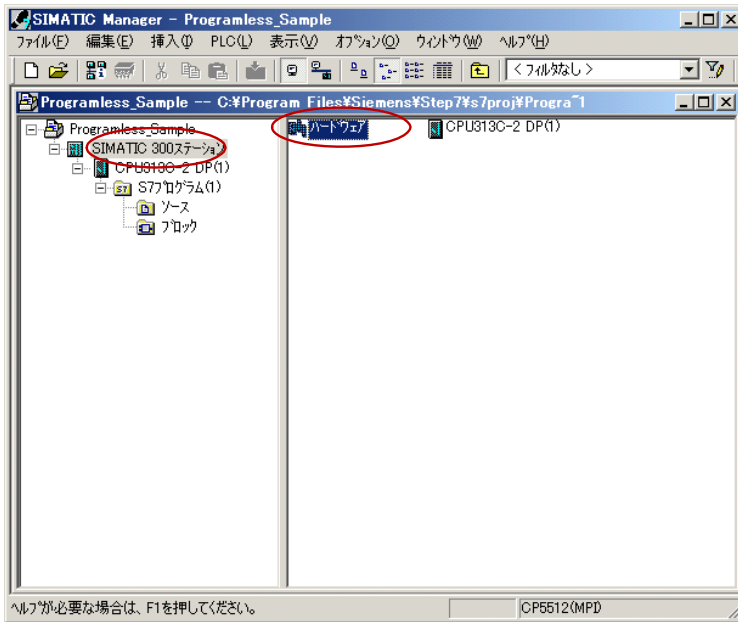

2. The "HW Config window opens. In the Hardware catalog on the right-hand pane, select SIMATIC300 > CP-300 > Point-to-Point > CP341 > CP 341 RS422/485, and drag and drop this onto the left-hand pane.

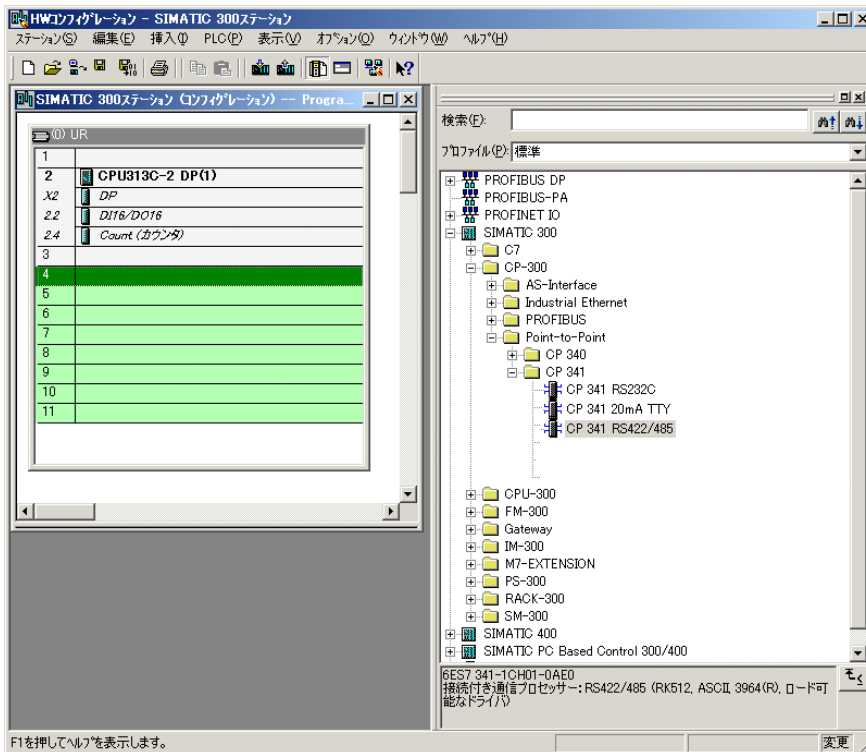

3. Double-click CP 341 RS422/485 on the left-hand pane.

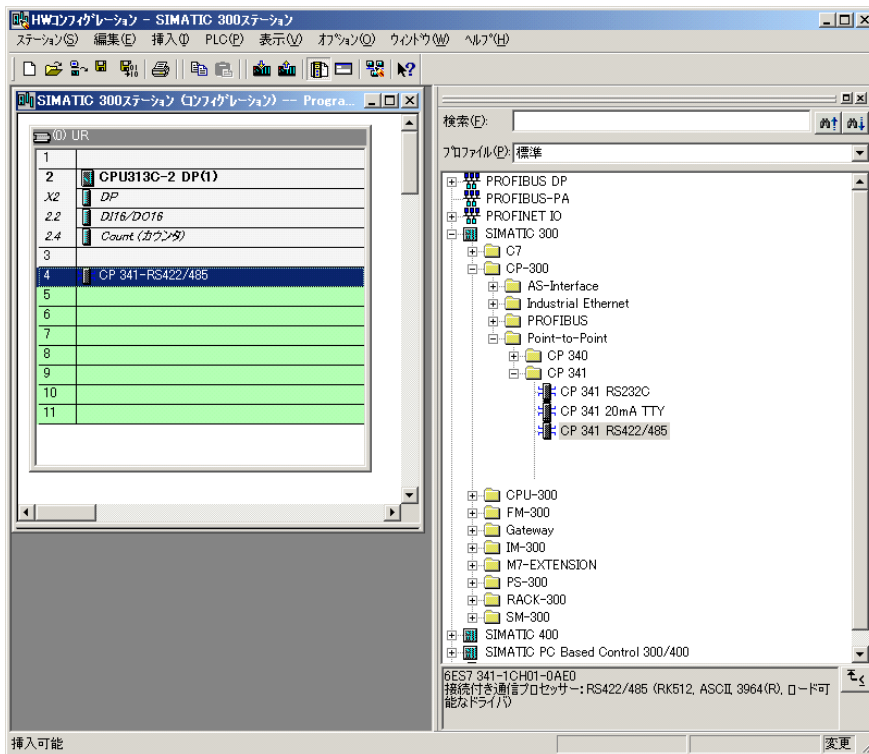

4. Click Parameter button.

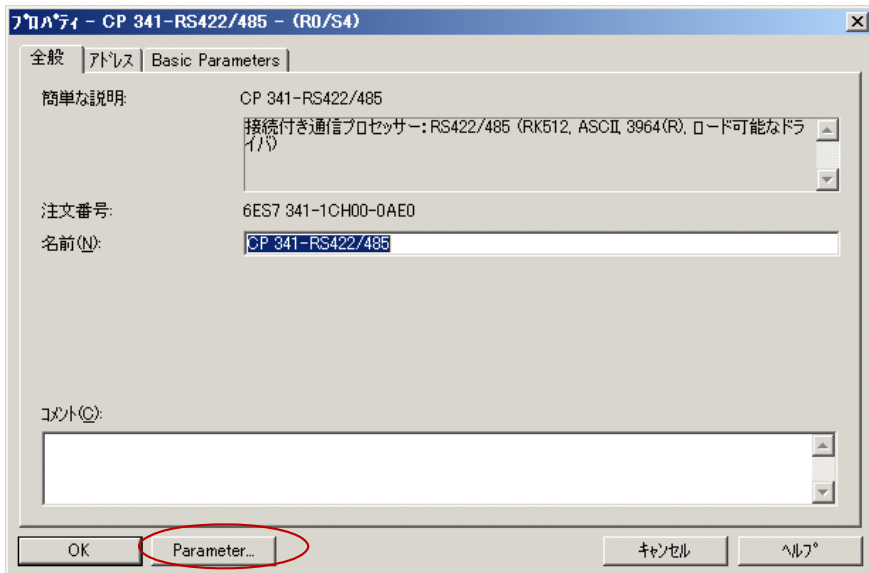

5. In the Protocol box, select MODBUS Slave.

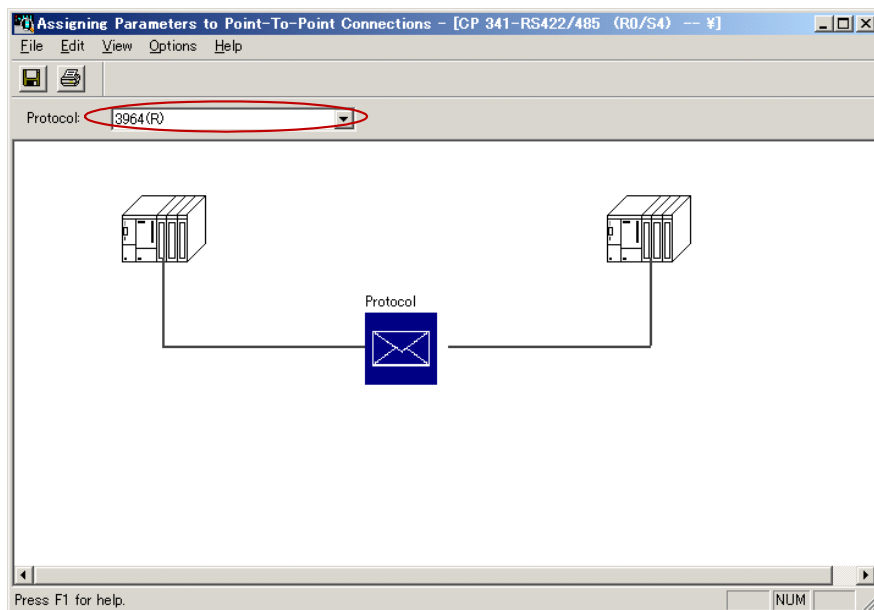



### 3 Loading the Modbus slave communication driver

1. Click Load Drivers to load the MODBUS slave driver.

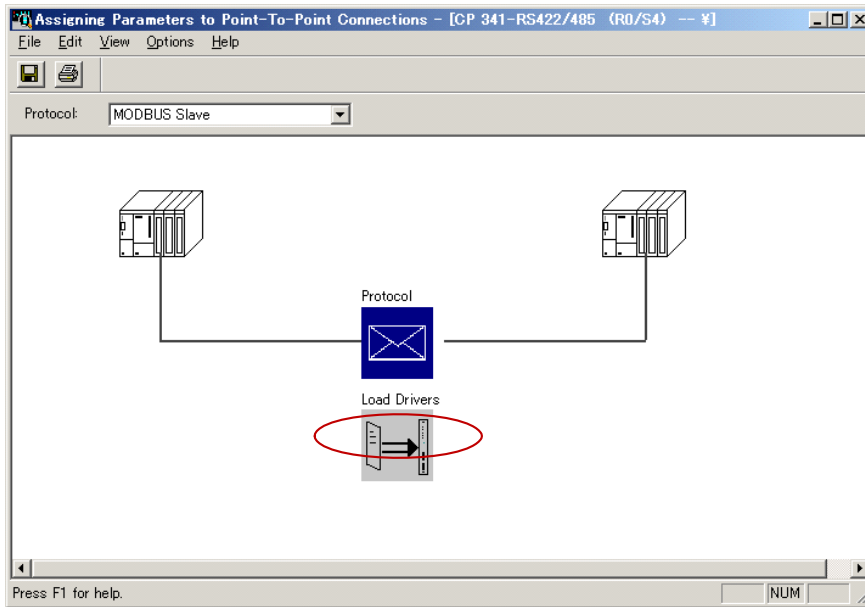

2. Click Load Drivers.

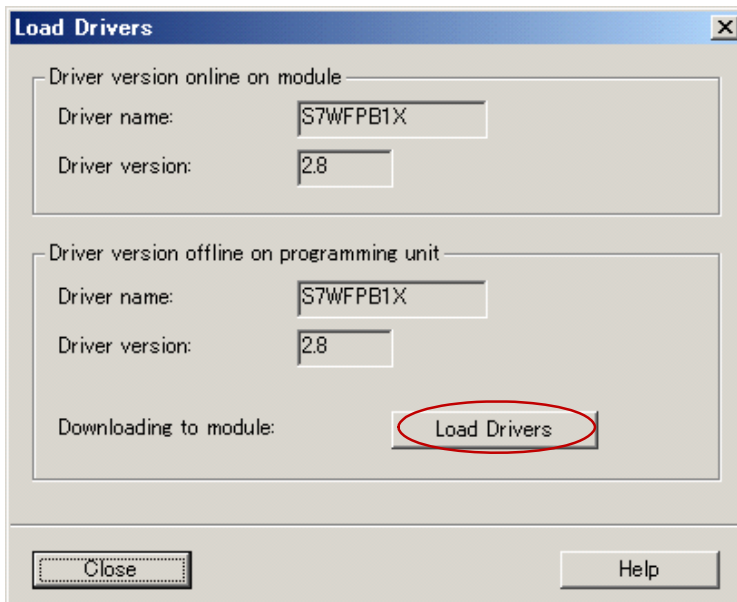

## 4 Setting communication conditions

1. Double-click Protocol.

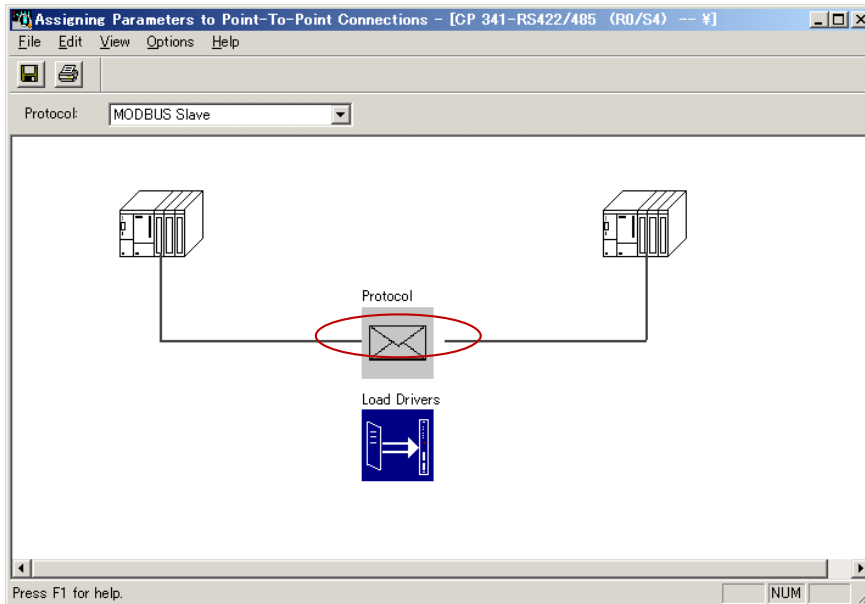

2. Select the Modbus-Slave tab.

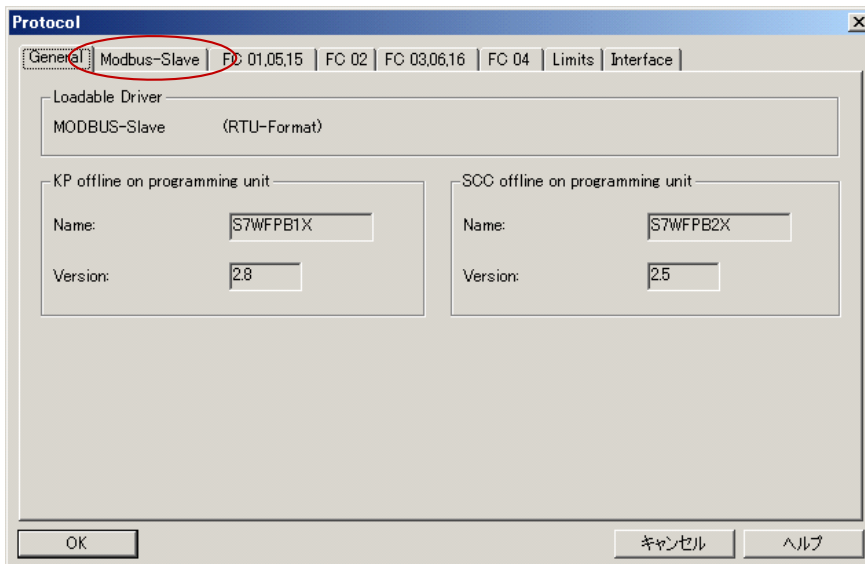

3. Enter baud rate, station number, stop bit, and parity.

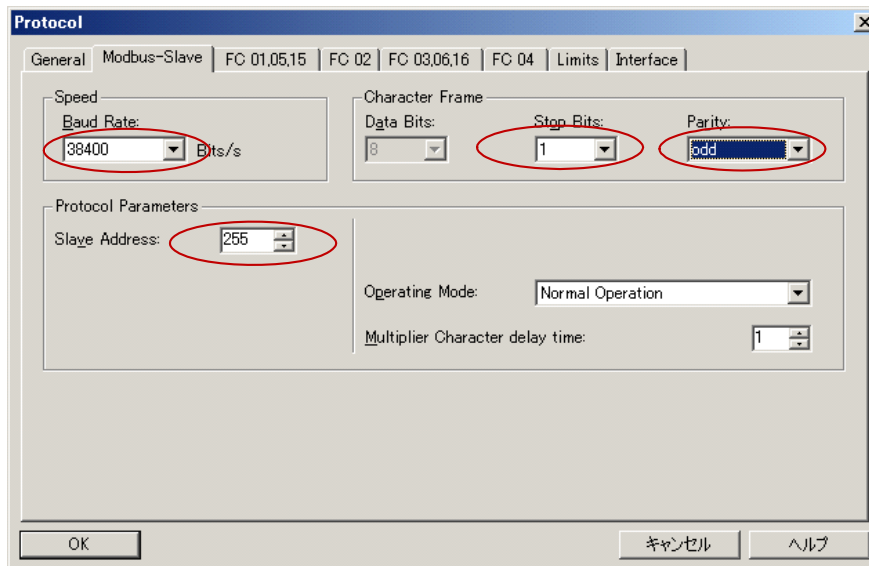

4. Select the FC 03,06,16 tab.

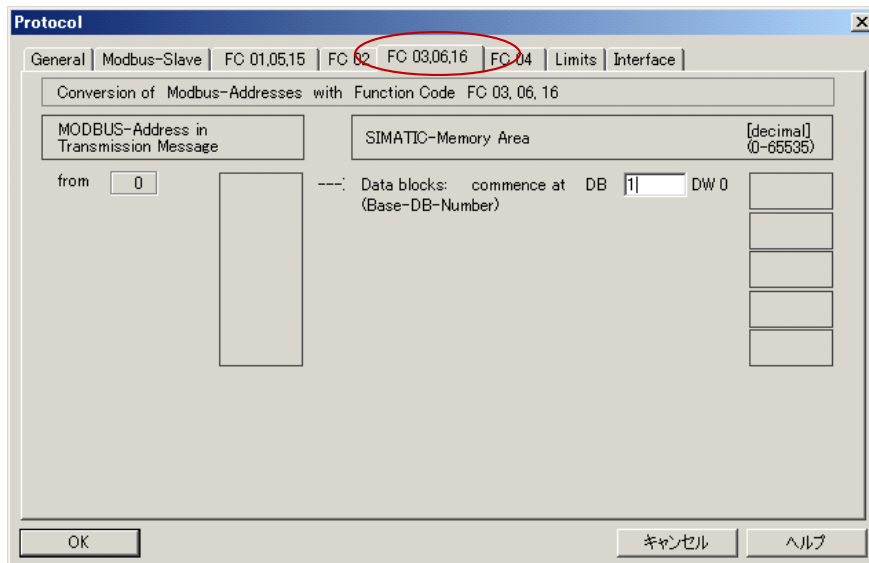

5. Enter a Base-DB-Number.

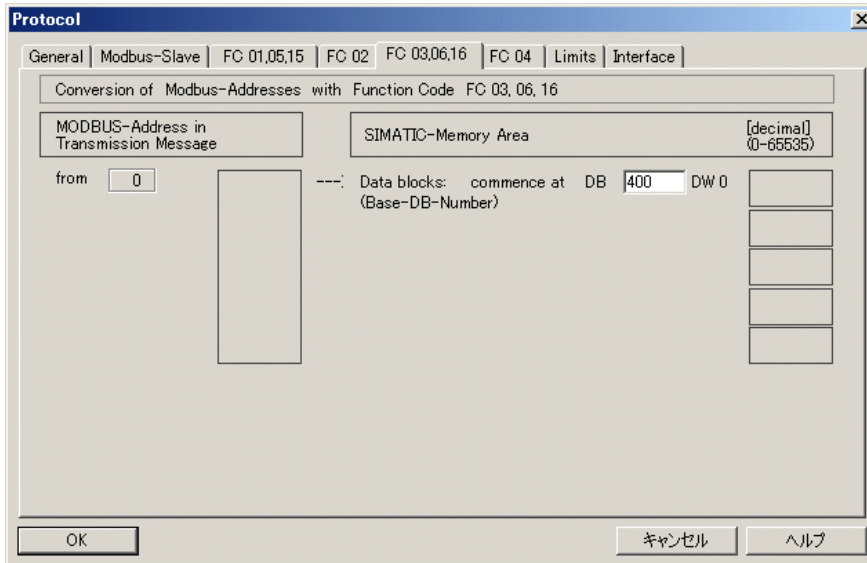

6. Select the Limits tab.

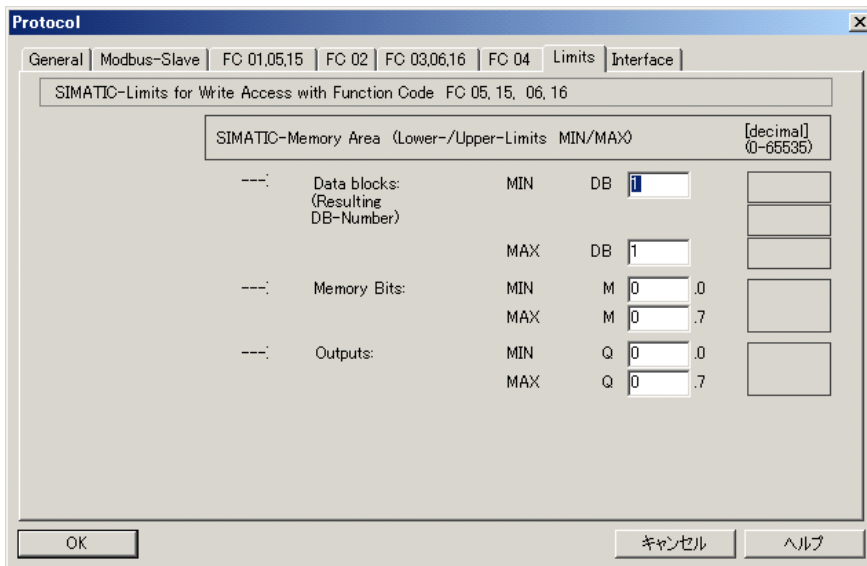

7. Enter the MIN and MAX values for Data blocks.

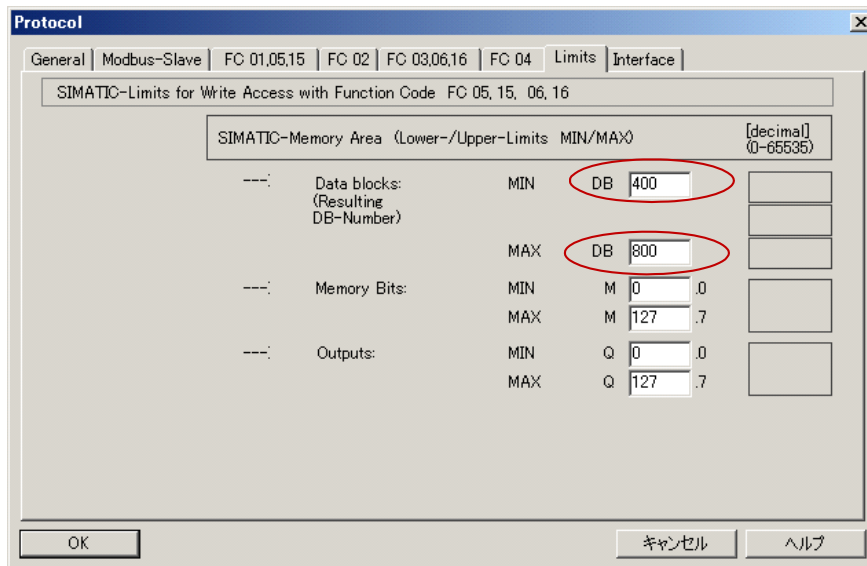

8. Select the Interface tab.

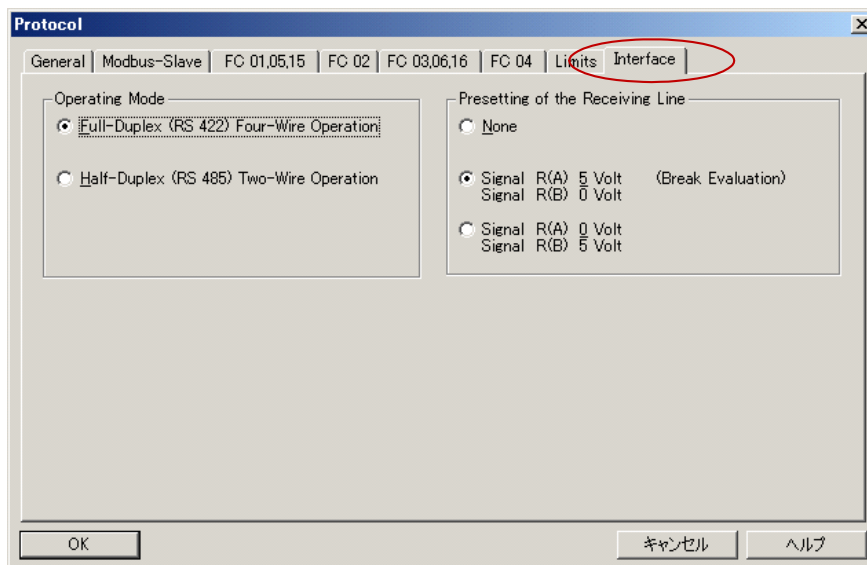

9. Select the operating mode you use, and click OK. The window goes back to "Property".

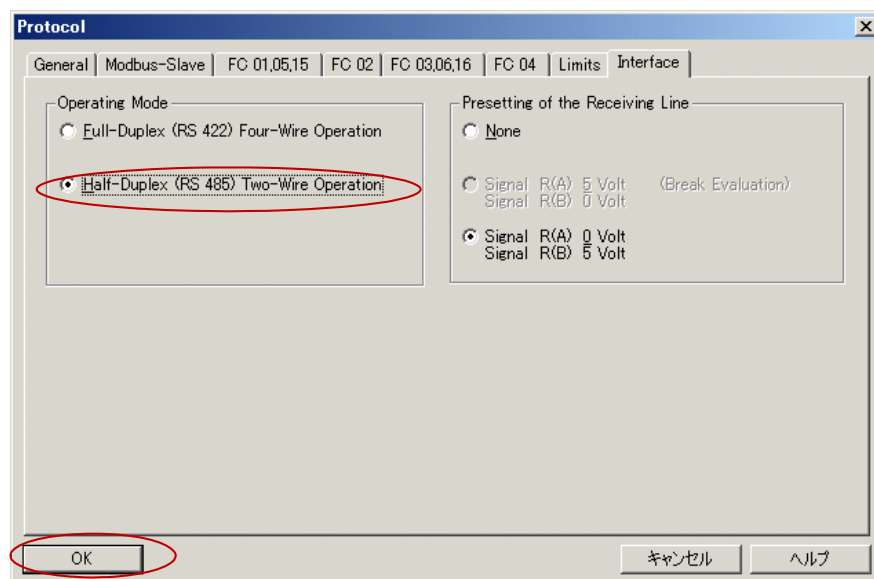

10. Click OK to go back to "HW config" window.

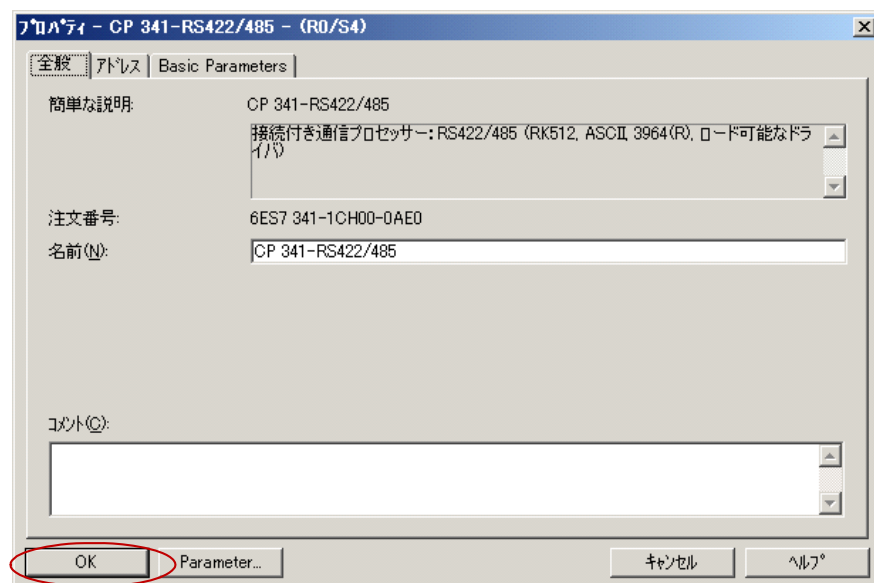

11. Close the "HW config" window to return to the SIMATIC Manager window.

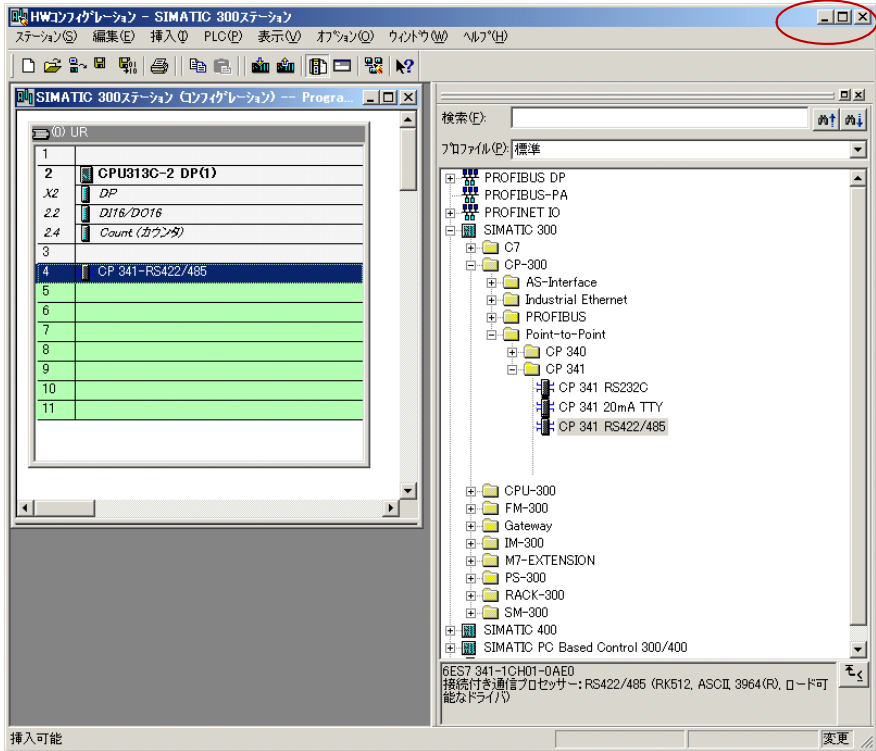

12. SIMATIC Manager window.

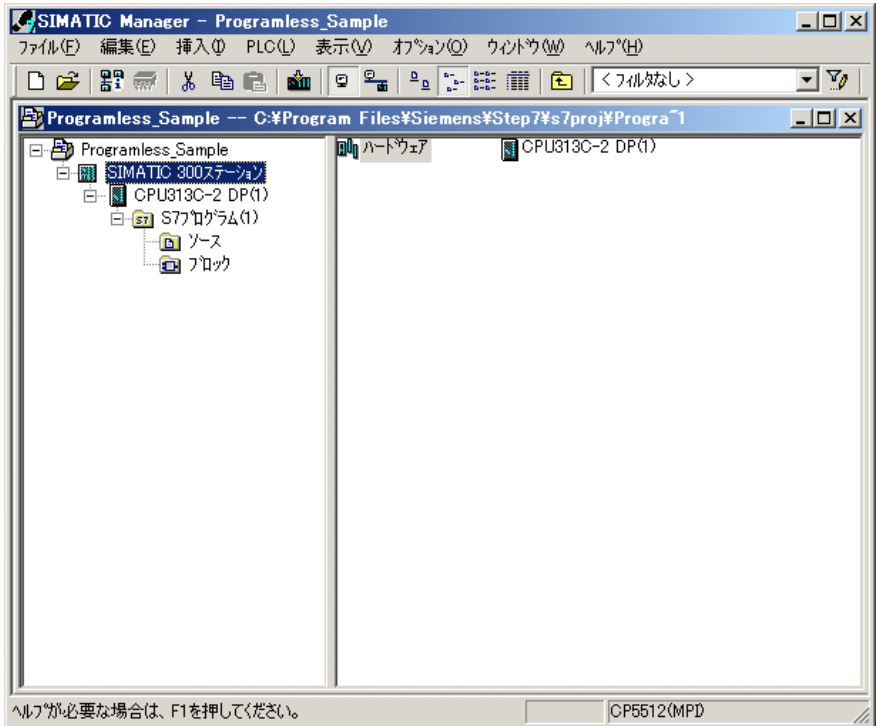

## 5 Creating and configuring a Modbus slave communication object

1. In the SIMATIC manager window, click Blocks folder to open it.

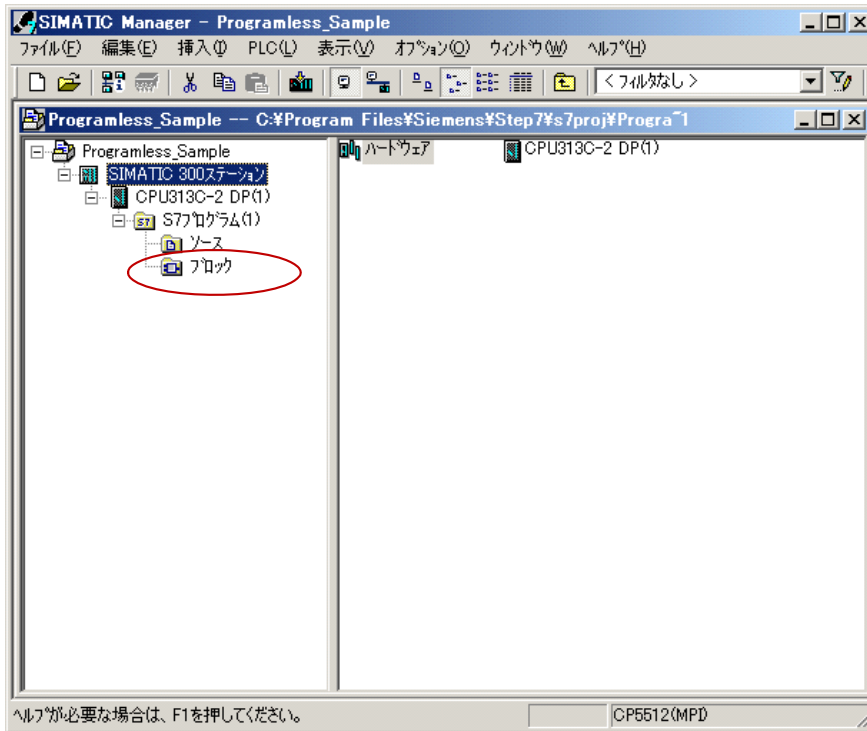

2. Double-click OB1 in the right-hand pane.

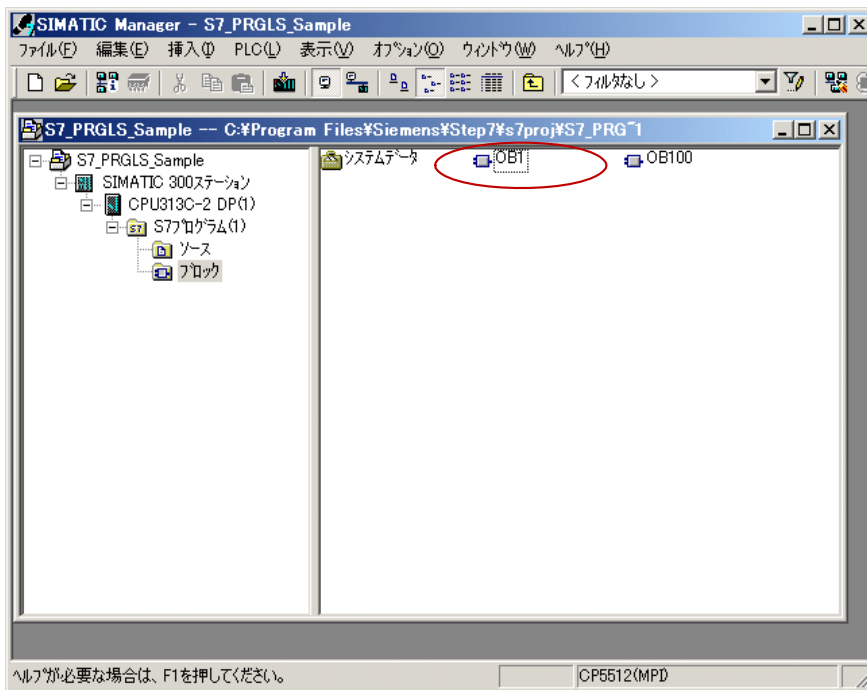



3. Select Modbus > FB7 from the project structure in the left-hand pane, and drag and drop it onto the program input line in the lower right.

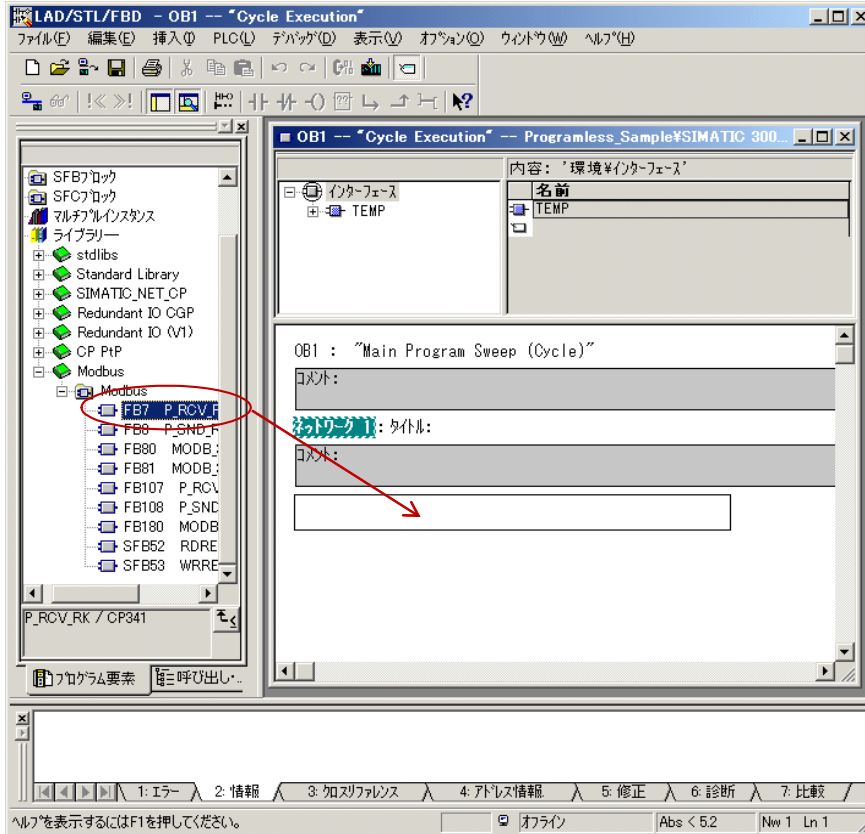

4. Delete "CALL FB 7," in the program input line.

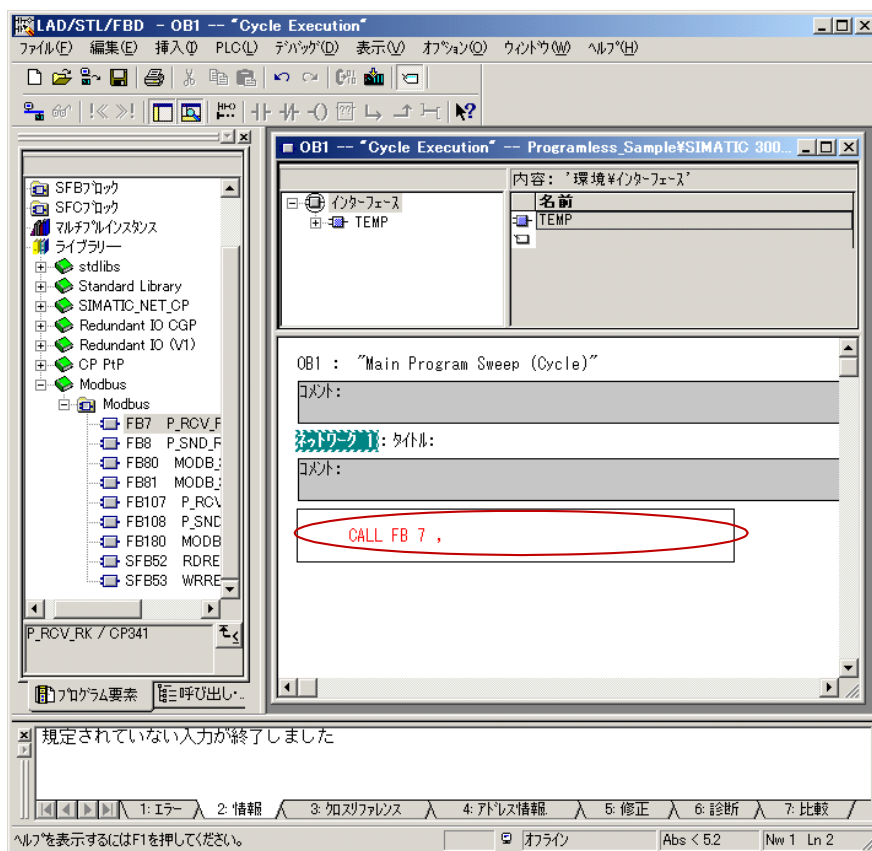

5. Repeat the same steps for FB8.

6. Select Modbus > FB80 from the project structure in the left-hand pane, and drag and drop it onto the program input line in the lower right.

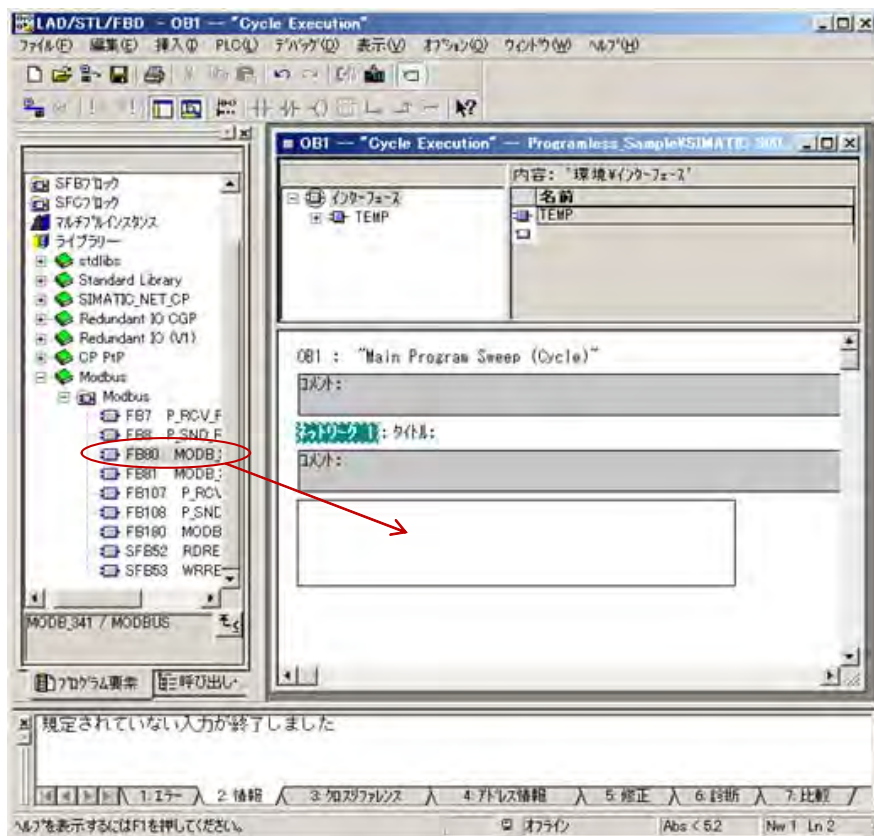

7. Enter DB80, and press the Enter key.

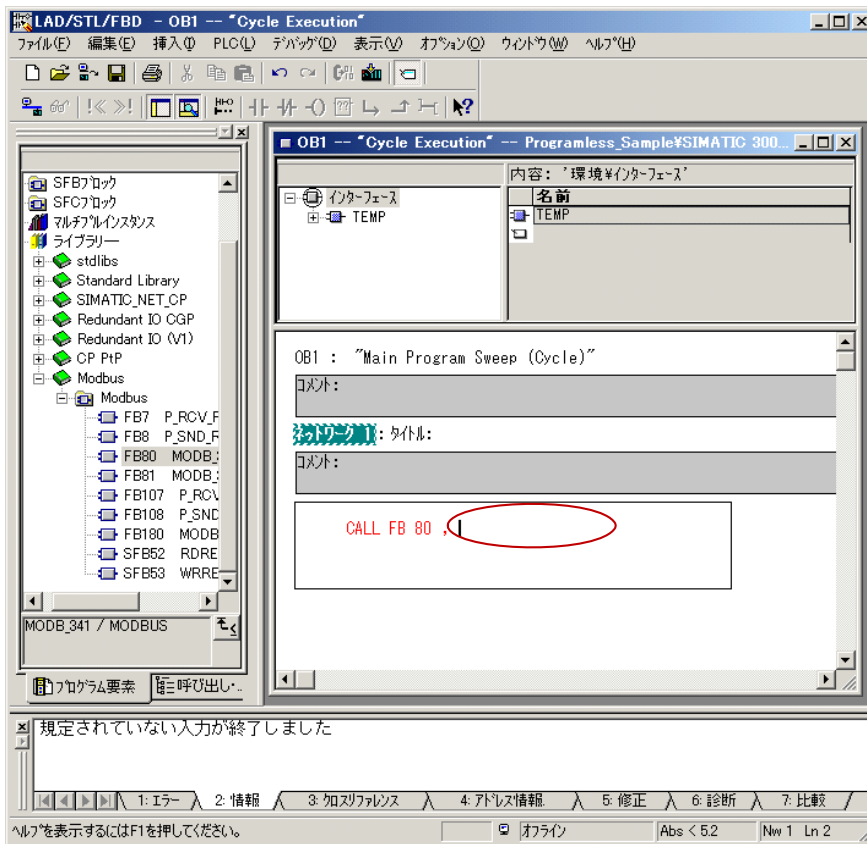

8. The following dialog box appears. Click YES.

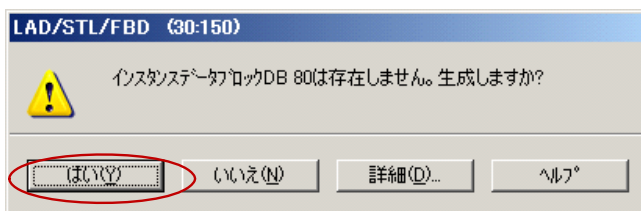

9. Enter the following values.

```

LADDR                :=256      // ! I: Modul Address
START_TIMER          :=T120     // ! I: Timer for "Timeout initialisation"
START_TIME           :=S5T#5S  // ! I: Time value "Timeout initialisation"
OB_MASK              :=TRUE     // ! I: Mask access errors
CP_START             :=M180.0   // ! I/O: Start of CP initialisation
CP_START_FM          :=M180.1   // ! I/O: Edge flag for CP_START
CP_NDR               =M180.2    // ! I/O: Info: New write job from CP
CP_START_OK          :=M180.3   // ! I/O: Initialis. finished without error
CP_START_ERROR       :=M180.4   // ! I/O: Initialis. finished with error
ERROR_NR             :=MW182    // ! I/O: Error number
ERROR_INFO           :=MW184    // ! I/O: Error additional info
    
```

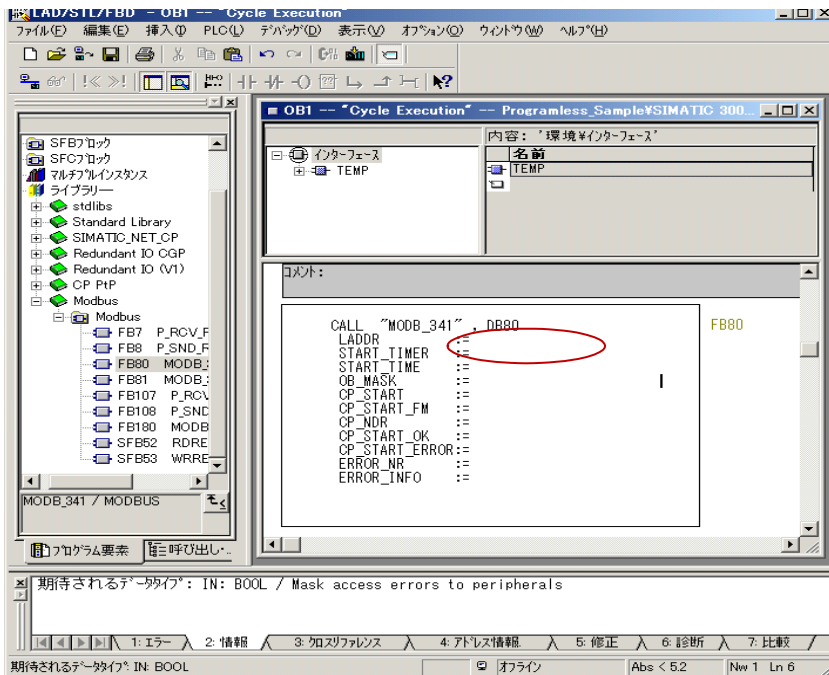

When you finished, the screen will be as follows.

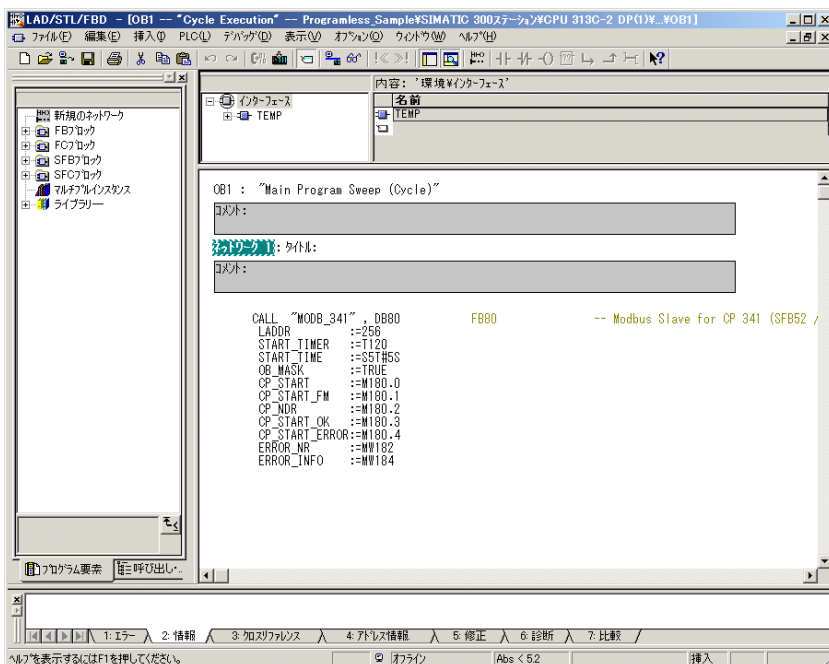

10. Close the window to return to the following screen, and double-click OB100.

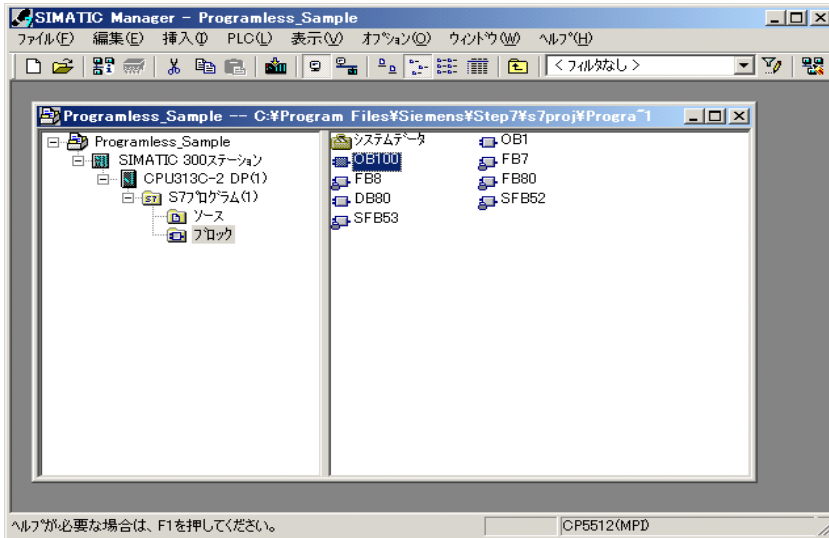

11. Enter the following instructions and save the data. Close the window.

```
AN    M 180.0    // Set initialisation flag CP_START
S     M 180.0
A     M 180.1    // Reset edge flag CP_START_FM
R     M 180.1
```

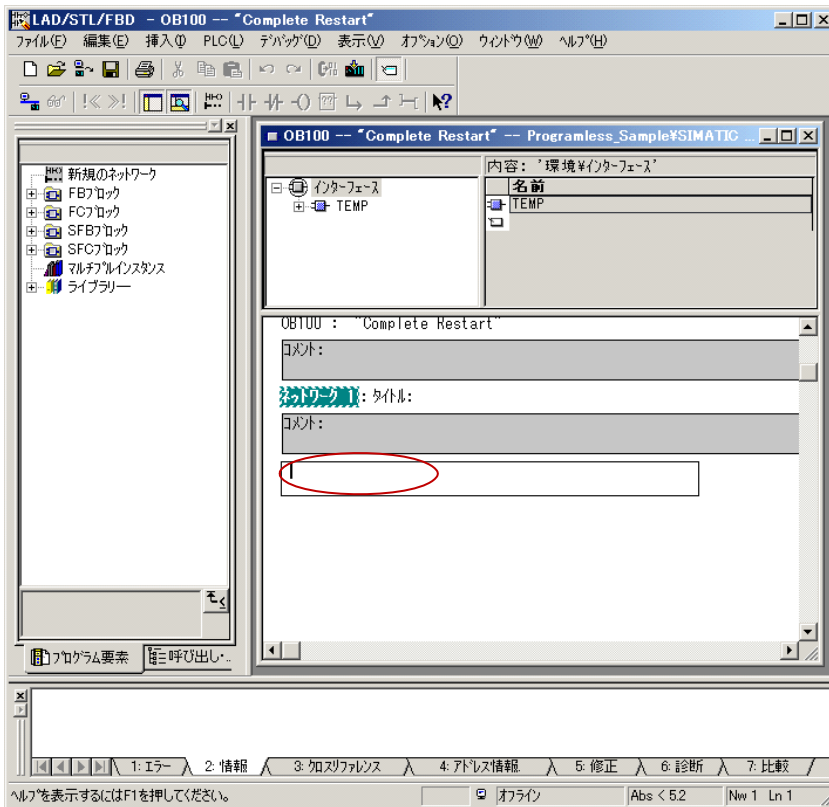

When you finished, the screen will be as follows.

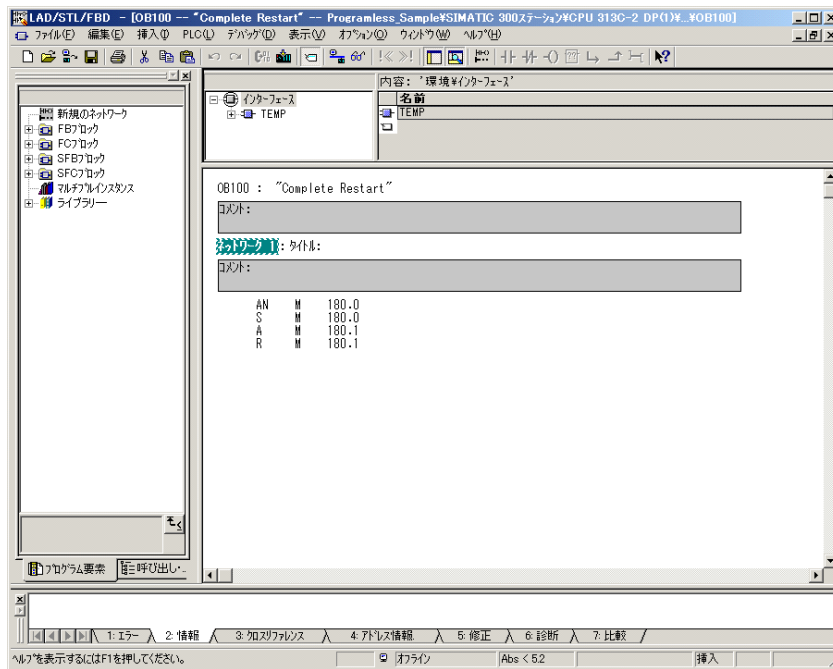

## 6 Creating a data block of holding register

1. Click in the right-hand half of the window with the right mouse button. Select Insert New Object > Data Block in the pop-up menu.

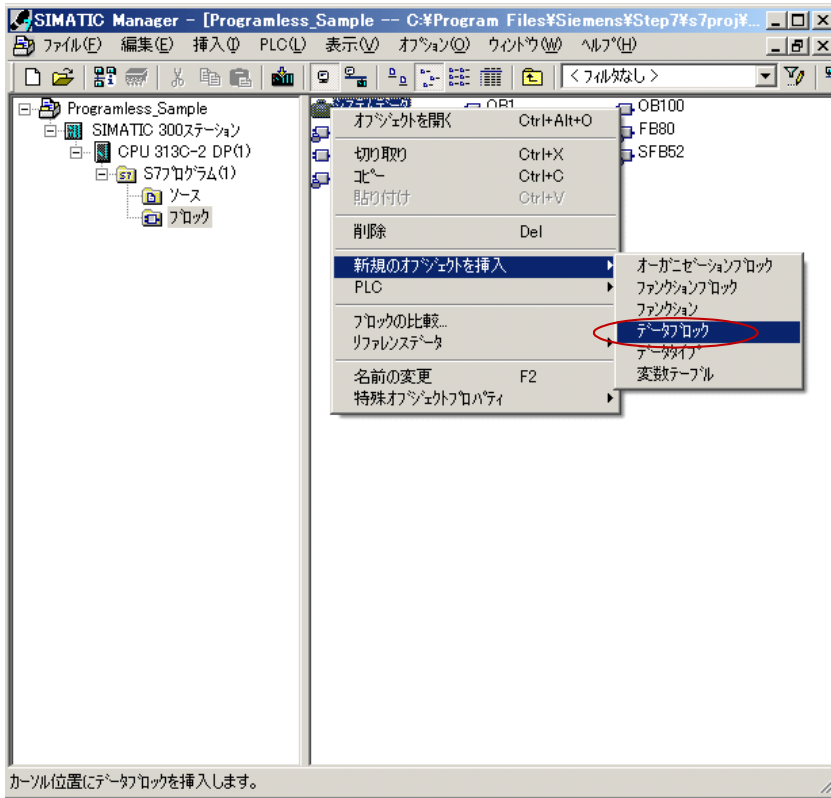

2. Enter the name "DB400", and click OK.

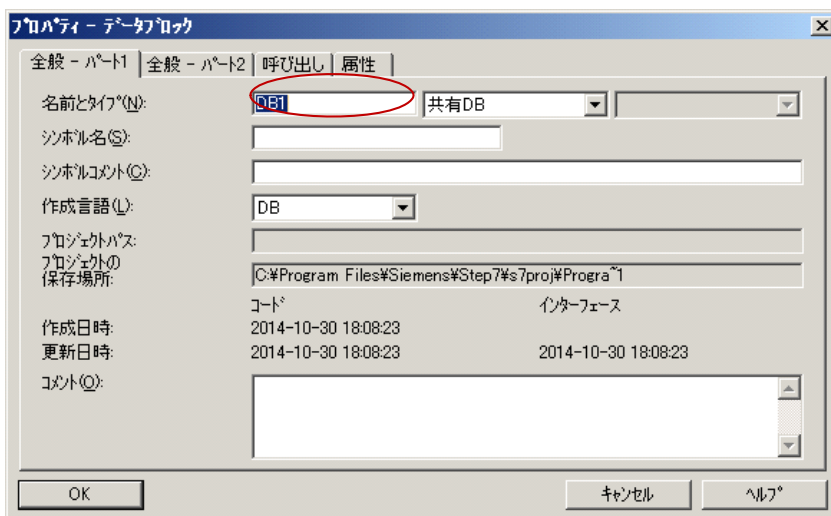



3. Double-click DB400 in the Blocks folder.

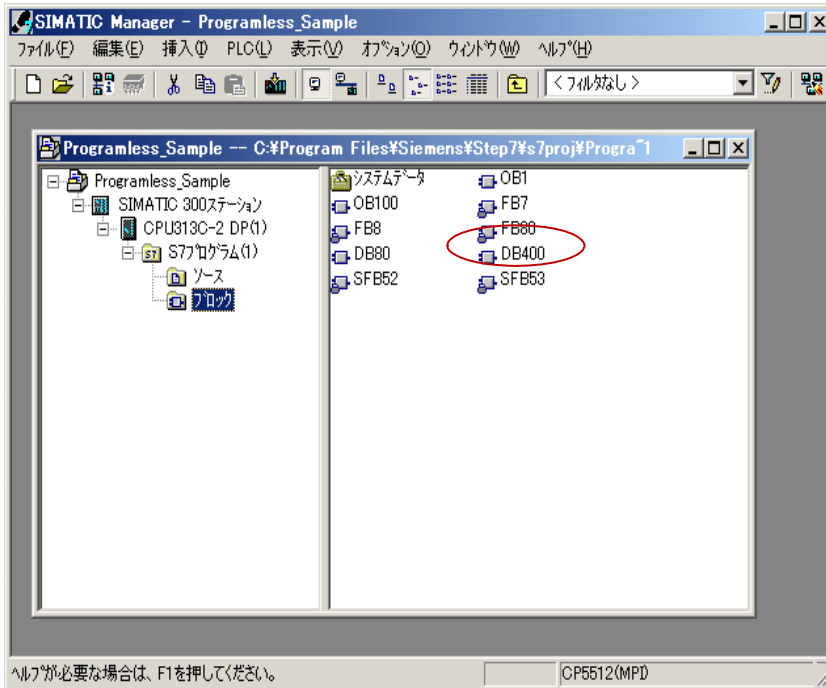

4. Define the holding register array, and close the window.

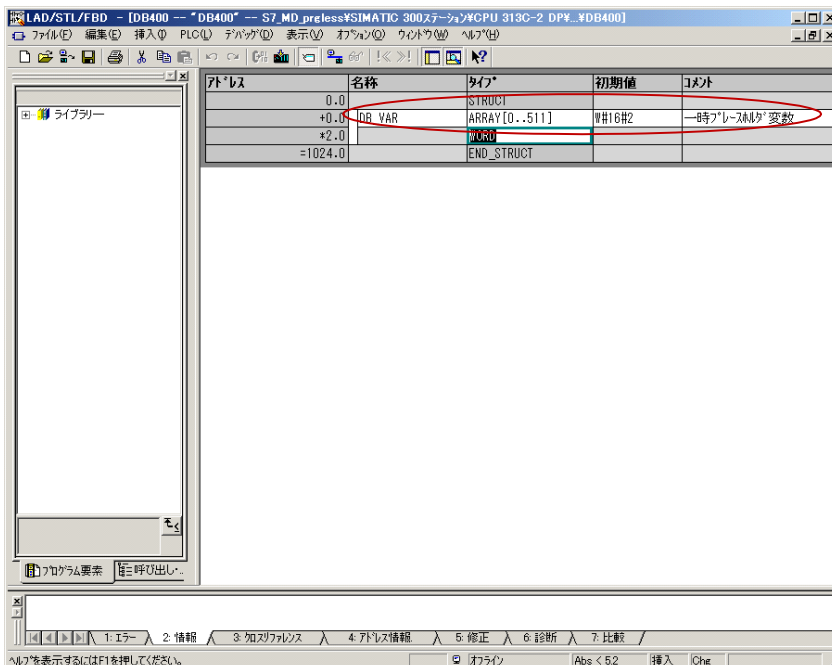

## 7 Compiling and downloading the configuration

1. In the main screen of SIMATIC Manager, select "Compile and Download Objects" in the PLC menu.

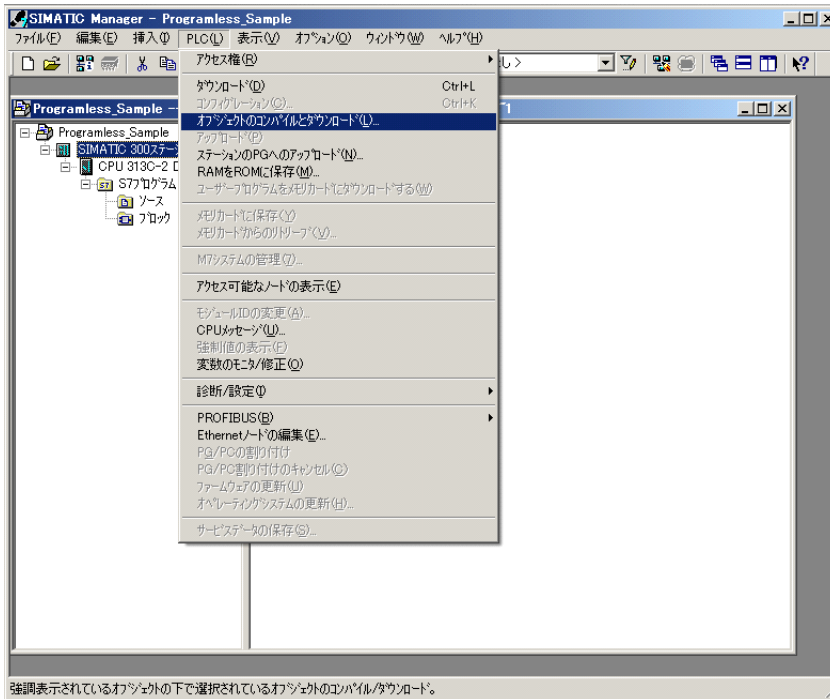

2. Configure the necessary items, and click Start to start compiling and downloading to PLC.

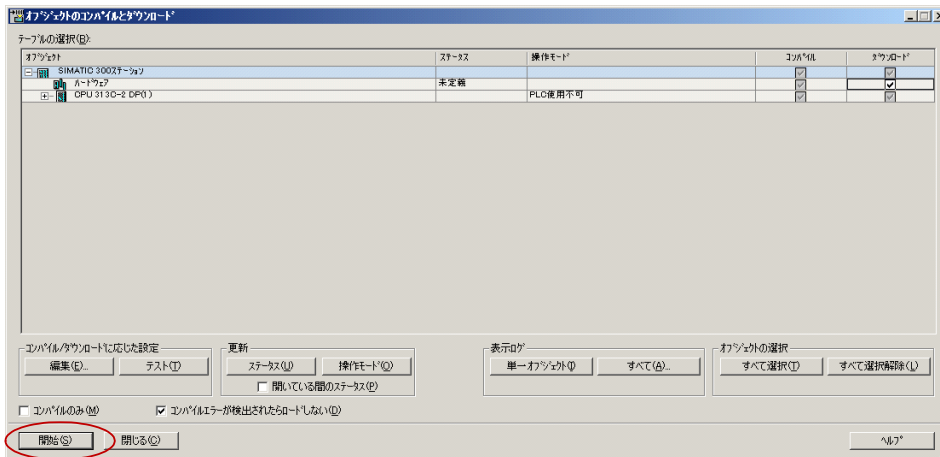

# Troubleshooting

Check the following items when the unit cannot communicate.

- Is the power turned on to all of the equipment related to communication?
- Are the wire connections correct? (Are the + and – poles matching?)
- Are the communication settings the same between the master (the top computer) and the slave (micro controller)?
  - Communication speed : 9600bps, 19200 bps, 38400bps, 115.2kbps
  - Data : 8-bit
  - Stop bit : 1-bit
  - Parity :  Odd
    - Even
    - None
- Does the transmission signal timing satisfy "Chapter 5, MODBUS Communication Protocol" (p. 19)?
- Is the station number specified as the sending location from the master set at something other than "0"?  
The communication function does not work when set to "0".
- When using RS-485, is the 7th digit of the model number (PXF□□□■□□□□□□) any of M, or F?
- When using RS-485, are the communication settings the same for the RS-232C to RS-485 converter?



---

**Fuji Electric France SAS**

46 rue Georges besse - ZI du Brézet

63039 Clermont Ferrand cedex 02 - France

Tél: 04 73 98 26 98 Fax: 04 73 98 26 99

Web: [www.fujielectric.fr](http://www.fujielectric.fr)

Email : [sales.dpt@fujielectric.fr](mailto:sales.dpt@fujielectric.fr)

---