

# FD6000 SERIE

3072793 15-05-2018

## INSTRUCTIONS MANUAL



## FD6200 v2.0

COUNTER - TOTALIZER  
TACHOMETER - TOTALIZER  
FREQUENCY METER  
CHRONOMETER – HOUR METER



# INDEX

<b>1. OVERVIEW</b> .....	4
1.1 Introduction to model FD6200 .....	4
<b>2. GETTING STARTED?</b> .....	7
2.1 Dimensions and mounting.....	8
2.2 Programming guide .....	9
2.3 Power Supply. Connectors.....	11
2.4 Description functions keys and LED's in programming mode and mode RUN.....	12
2.5 Input signal (CN2) Connection.....	13
<b>3. INPUT PROGRAMMING</b> .....	14
3.1 Selection of sensor type.....	14
3.2 Diagram of programming mode: COUNTER .....	15
3.3 Counter configuration .....	16
3.4 Mode count programming .....	17
3.5 Programming of display .....	19
3.5.1 Options of the Process Variable .....	19
3.5.2 Brightness level configuration.....	19
3.5.3 Totalizer Option .....	19
3.5.4 Totalizer visualization .....	20
3.6. Programming diagram in MODE: CHRONOMETER .....	21
<b>4. CHRONOMETER CONFIGURATION</b> .....	22
4.1 Run mode programming .....	23
<b>5. FREQUENCY METER / TACHOMETER CONFIGURATION</b> .....	24
5.1 Frequencymeter / Tachometer .....	26
5.1.1 Frequencymeter.....	26
5.1.2 Tachometer RPM.....	26
5.1.3 Tachometer RATE .....	26
5.1.4 Tachometer DUTY . .....	28
5.2 Display Setup .....	29
5.2.1 Options of the Process Variable .....	30
5.2.2 TOTAL, MAX and MIN visualization .....	31

<b>6. LOGIC FUNCTIONS</b> .....	32
6.1 Programmable functions table .....	33
6.1.1 Logic functions diagram.....	33
6.2 Program of functions .....	34
<b>7. PROGRAM PARAMETERS AND KEYBOARD FUNCTIONS LOCK-OUT</b> .....	35
7.1 Security menu diagram .....	36
7.2 Restoration to factory configuration .....	38
<b>8. DIRECT ACCESS TO THE SETPOINTS VALUE PROGRAMMING</b> .....	38
<b>9. OUTPUT OPTIONS</b> .....	39
9.1 SETPOINTS OUTPUT.....	41
9.1.1 Introduction.....	41
9.1.2 Installation.....	42
9.1.3 Wiring .....	42
9.1.4 Technical specifications.....	43
9.1.5 Setpoints menu diagram in mode Frequncymeter / Tachometer .....	44
9.1.6 Description of operation in mode Frequncymeter, Tachometer .....	45
9.1.7 Setpoints menu Diagram in mode Counter / Chronometer .....	46
9.1.8 Description of mode relays operating as Counter / Chronometer .....	46
9.2 OUTPUT RS2/ RS4 / ETH.....	48
9.2.1 Introduction.....	48
9.2.2 Diagram of the menu Output RS .....	49
9.3 ANALOG OUTPUT .....	53
9.3.1 Introduction.....	53
9.3.2 Installation of NMA or NMV option.....	53
9.3.3 Connection .....	54
9.3.4 Technical specifications.....	55
9.3.5 Analog output menu diagram .....	55
<b>10. TECHNICAL CHARACTERISTICS</b> .....	56
<b>CONFORMITY CE</b> .....	58
<b>WARRANTY</b> .....	59

# 1. OVERVIEW

## 1.1 Introduction to model FD6200

The MICRA-D model from the FD6000 SERIE is a five tricolor digit instrument with 2 programmable inputs that accept signals from a variety of standard sensors and pulse generators. Can be configured to work as:

- TACHOMETER + TOTALIZER (8 digits)
- TACHOMETER + DIRECTION OF ROTATION INDICATION
- FREQUENCYMETER
- COUNTER 5 digits + TOTALIZADOR (8 digits)
- SEVERAL MODES OF COUNTER (UP, DOWN, UP/ DOWN, PHASE)
- CHRONOMETER / HOUR METER (5 digits)

Standard features of the basic instrument include the reading of the input variable as well as remote hold, reading and memorisation of max and min values (peak/ valley), tare and reset function, and a full complement of programmable logic functions.

FD6200 model can also incorporate the following output options:

### COMMUNICATION

**RS2** Serial RS232C

**RS4** Serial RS485

**ETH** Ethernet

### CONTROL

**NMA** Analogue 4-20mA

**NMV** Analogue 0-10V

**2RE** 2 Relays SPDT 8A

**4RE** 4 Relays SPST 5A

**4OP** 4 NPN output

**4OPP** 4 PNP output

All the output options are opto-isolated from input signal and power supply.

## **PARTIAL COUNTER**

- Programmable decimal point
- **UP** mode, **DOWN** mode and **UP / DOWN** mode
- Programmable multiplier or divisor factor from 0.00001 to 99999
- Start value of programmable counting

### **5 counting modes, 2 inputs A and B**

- Unidirectional 1 way A
- Unidirectional 1 way A + Stop counting way B
- Differential 2 ways A-B
- Bidirectional 1 way A + Sense B (up / down)
- Two-way bidirectional A and B

### **5 operating cycles, 2 or 4 presets**

- Permanent comparison of the presets
- Chained Mode
- Cascade Mode

## **CHRONOMETER / HOUR COUNTER**

- 4 Hour Resolutions
- 999s 99 / 100s - 999m 59s - 999h 59m - 99999h
- Up or down count
- Programmable OFFSET (start value)

### **2 counting modes, 2 inputs A and B**

- Account while input A is active
- Start counting A, Stop counting B

### **5 operating cycles, 2 or 4 presets**

- Permanent comparison of the presets
- Chained Mode
- Cascade Mode

## **TACHOMETER**

- Programmable decimal point
- Measurement and display of rpm, linear speed, flow
- Detection of direction of rotation
- Measurement and display of "duty cycle PWM".
- Programmable multiplier or divisor factor from 0.0001 to 99999

### **2 counting modes, 2 inputs A and B**

- Unidirectional 1 way A
- Bidirectional 2 separate ways A and B

### **MIN, MAX functions**

- The MIN and MAX functions permanently register the minimum and maximum values of the measurement.

### **Operating cycle, 2 or 4 presets**

- Permanent comparison of the presets, high level (higher speed) as low level (lower speed)

## **FREQUENCY METER**

- Programmable decimal point
- Hz display unit

### **MIN, MAX functions**

- The MIN and MAX functions permanently register the minimum and maximum values of the measurement.

### **Operating cycle, 2 or 4 presets**

- Permanent comparison of presets, level high and low level

## **GENERAL TOTALIZER OF IMPULSES OR HOURS**

- Two information of the same signal.

Example: Indication of Flow and Expense, typical case in the measurement of fluid velocity and consumption of same.

- 8 Digits with sign, -99999999 to 99999999
- Programmable decimal point
- Up or down count
- Impulse conversion factor
- Initial value Offset with sign

### **5 counting modes, 2 inputs A and B**

- Unidirectional 1 way A
- Unidirectional 1 way A + Stop counting way B
- Differential 2 ways A-B
- Bidirectional 1 way A + Sense B (up / down)
- Two-way bidirectional A and B

### **5 operating cycles, 2 or 4 presets**

- Permanent comparison of the presets
- Chained Mode
- Cascade Mode

All the configurations also have PROGRAMMABLE LOGICAL FUNCTIONS, which can be made through the rear connector and which give the equipment extra functions that can be controlled remotely.

In addition, commands are available through the serial channel that allow the control and modification of the values of the setpoints, read the value of the counters, reset them, etc.

It allows the total or partial blocking of the programming by means of a 4-digit numerical code.

It has the possibility of returning to factory settings.

It allows the programming of the color of the display, be it red, green or amber, assignable to: programming, partial count value, total, setpoints, when a relay activation occurs, etc.

## **2. GETTING STARTED**

### **Packing contents**

- ❑ Instruction manual in English including declaration of conformity
- ❑ Digital panel meter FD6200.
- ❑ Accessories for panel mounting (sealing gasket and fixing clips).
- ❑ Accessories for wiring connections (plug-in terminal block connectors with a fingertip key).
- ❑ Wiring label stuck to the FD6200 case.
- ❑ 4 set of labels with engineering units.
- ✓ ***Check the packing contents.***

### **Programming instructions**

- ❑ The Instrument includes software that allows, via keyboard, accessing to several independent programming menus for configuration of the input, the display and the logic functions. If additional options are installed (serial outputs, analogue output and relays output, once recognised by the instrument, they activate their own programming software.
- ✓ ***Read carefully this section.***

### **Programming lock-out (Page 35).**

Software allows total programming lockout but also selective lockout of the programming parameters.

- ❑ The instrument is delivered from factory with unlocked programming, e.g., with all the programming levels accessible to the operator

***Write down the security code and keep it in a secure place.***

The figure below shows the locations of the different output options available.

The **2RE**, **4RE**, **4OP** and **4OPP** options are alternative and only one of them can be installed in the M1 connector.

The **RS2**, **RS4** and **ETH** options are also alternative and only one of them can be installed in the M2 connector.

The **NMA** or **NMV** are also alternative and only one of them can be installed in the M3 connector.

Up to three output options can be installed and operate simultaneously:

- 4-20mA or 0-10V (only one)
- RS232C or RS485 or ETH (only one)
- 2 RELAYS, 4 RELAYS or 4 OPTO (only one).

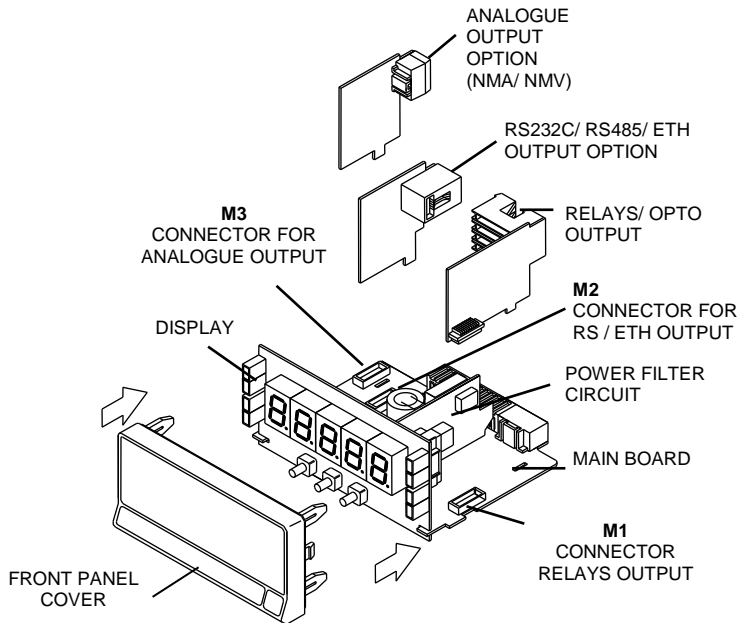

## 2.1 Dimensions and mounting

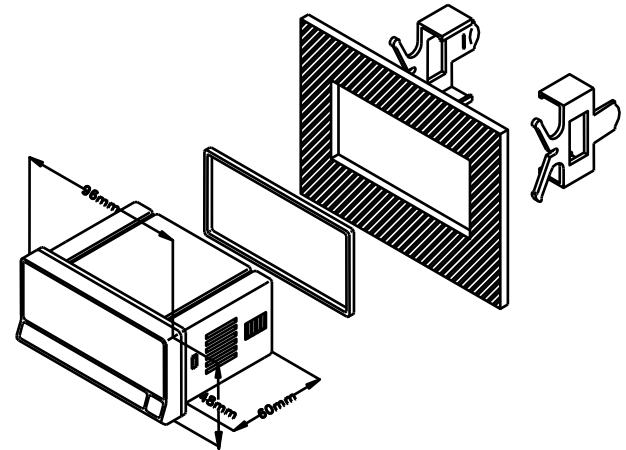

Front: 96 x 48 mm Depth: 60 mm  
Panel cut-out: 92 x 45 mm

CLEANING: frontal cover should be cleaned only with a soft cloth soaked in neutral soap product.  
DO NOT USE SOLVENTS



## 2.2 Programming guide



### How to get into programming mode?

First, plug the instrument to the corresponding supply, automatically a display test will be done and after that the software version will be shown then the instrument will go to work mode. Second, press the  key to enter into the programming mode, the indication "-Pro-" will appear on the display then.

### How to store programmed parameters?

If we want to save the changes that we have done in the programming, we must complete the programming of all the parameters contained in the routine we are in. In the last step of the routine, as a result of pressing on the  key, "StorE" will be displayed during a few seconds, meanwhile all the data are stored in memory. Then the instrument will go back to working mode.

### How is programming routine organised?

Programming software is composed by a number of menus and submenus hierarchically organized. On figure below, beginning with indication "-Pro-", press repeatedly  to get access to programming menus. Modules 3, 4 and 5 will only be shown if the option for setpoints, analogue output or RS option has been plugged in. Selecting one menu, the access to the different programming submenus is done by pressing .

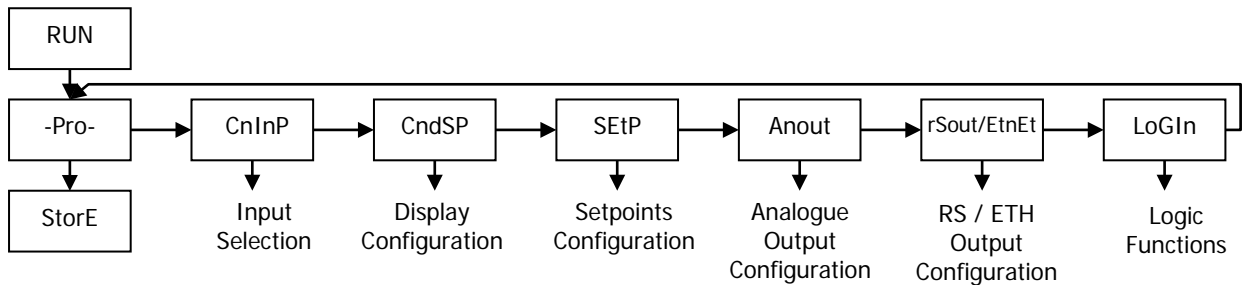



Module selection level

## Accessing to programmed parameters

Thanks to the tree structure, the programming routines allow to access to one parameter and modify it without passing through the whole list of parameters.

## To advance through programming

The progress through the programming routines is done by pressing  key.

In general, the steps to be done will be push  key a certain number of times to select an option and push  key to validate the change and going forward to the next step of the program.

The numerical values are programmed digit by digit as explained in the next paragraph.

## Programming numerical values

When the parameter is a numerical value, the first of the digits to be programmed will appear blinking on display.

The method of introducing a value is as follow:

**Digit selecting:** Press repeatedly the  key to shift from left to right over all the display digits included the LED direction indicators (when the programmed function requires it).

**Changing the digit value:** Press repeatedly the  key to increase the value of blinking digit until it has the desired value or to alternate the LED Up and Down arrows indicators (MAX and MIN).

## Selecting an option from the list

When the parameter is an option to be chosen among different possibilities, the  key allows you to browse through the list of options until you find the desired parameter

## 2.3 – Power supply and connectors

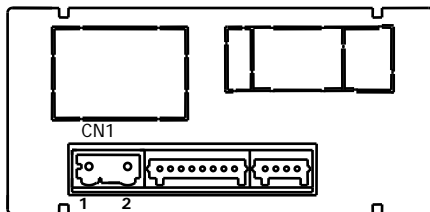
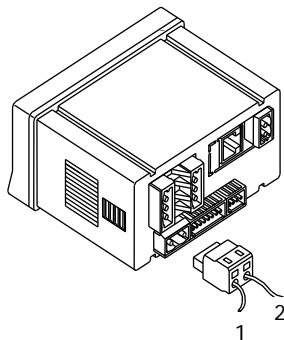

### WIRING and POWER SUPPLY RANGE FD6200

85 V – 265 V AC 50/ 60 Hz or 100 – 300 V DC

### MICRA-D6

22 – 53 V AC 50/ 60 Hz or 10,5 - 70 V DC

Borne 1: Phase

Borne 2: Neutral

**NOTE:** When DC power supply (direct) polarity in connector CN1 is indistinct.

**WARNING:** If not installed and used in accordance with these instructions, protection against hazards may be impaired.

In order to guarantee the electromagnetic compatibility, the following guidelines should be kept in mind:

- Power supply wires may be routed separated from signal wires.
- Never run power and signal wires in the same conduit.
- Use shielded cable for signal wiring and connect the shield to the ground.
- The cables section should be  $>0.25 \text{ mm}^2$

### INSTALLATION

To meet the requirements of the directive EN61010-1, where the unit is permanently connected to the mains supply, it is obligatory to install a circuit breaking device easy reachable to the operator and clearly marked as the disconnect device.

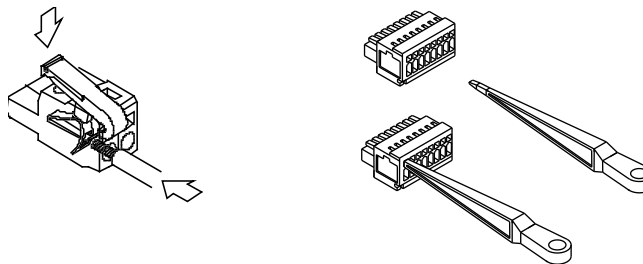

### CONNECTORS

**CN1** To perform wiring connections, strip the wire leaving from 7 and 10 mm exposed to air and insert it in the proper terminal while pushing the fingertip down to open the clip inside the connector as indicated in the figures. Each terminal accepts cables of section between  $0.08 \text{ mm}^2$  and  $2.5 \text{ mm}^2$  (AWG 26 ÷ 14).

## 2.4 Functions keys and LED's description in programming mode and RUN mode

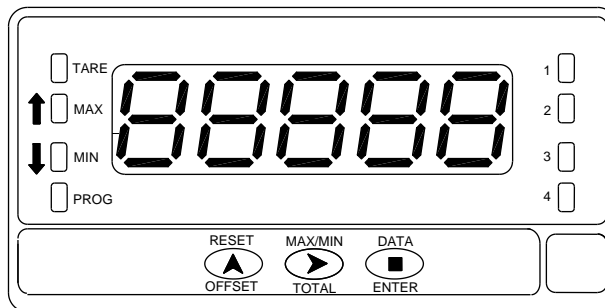

KEY	Function in programming mode
DATA ENTER	- to step forward in programming menu - to validate programmed values - to exit programming menu
MAX/ MIN TOTAL	- to move blinking digit
RESET OFFSET	- to increase blinking digit value - Direct access to Setpoints value
LED's	Function in programming mode
MAX	Indicates rotation sense (polarity)
MIN	Indicates rotation sense (polarity)
PROG	Indicates you are in programming mode

KEY	Function in RUN mode
DATA ENTER	- to enter programming menu or to visualize parameters if programming is locked
MAX/ MIN TOTAL	1st stroke allows TOTALIZER visualization (if activated) 2nd stroke allows Max visualization ( only Tachometer) 3 <sup>a</sup> stroke allows Min visualization ( only Tachometer) Following stroke: back to current value.
RESET OFFSET	In <b>Tachometer mode</b> reset of MAX/ MIN/ TOTAL (if present on display) In <b>Counter mode</b> Reset / OFFSET (starts measuring)
LED's	Function in RUN mode
MAX	<b>Fixed</b> indicates rotation sense or count polarity <b>Blinking</b> indicates visualization of a Max value
MIN	<b>Fixed</b> indicates rotation sense or count polarity <b>Blinking</b> indicates visualization of a Min value
PROG	Not active in run mode
1- 2 - 3 - 4	Indicates the activated Setpoint

## 2.5 – Input signal (CN2) Connection

Refer to connection recommendations on page 11

Instrument's rear view

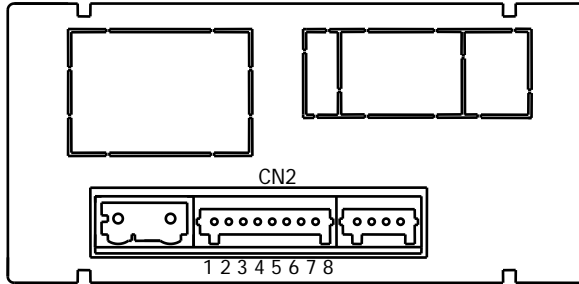

### CN2

- PIN 1 = No Connection
- PIN 2 = (+) 20 V Excitation
- PIN 3 = (+) 8,2 V Excitation Namur sensors
- PIN 4 = (-) Common excitation / input
- PIN 5 = Signal B input
- PIN 6 = Signal A input
- PIN 7 = No Connection
- PIN 8 = High voltage input (300 Vac max.)

#### MAGNETIC PICKUP

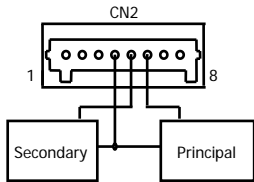

#### CONTACT CLOSURE

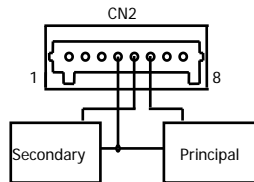

#### PNP/ NPN

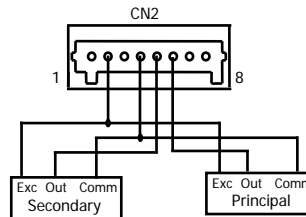

#### NAMUR sensor

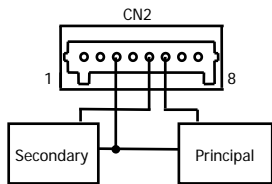

#### ENCODER

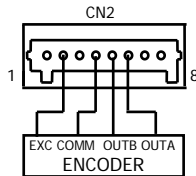

#### 10- 300 Vac (only 1 input)

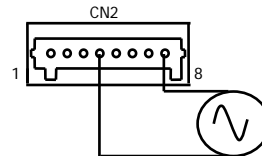

# 3. INPUT PROGRAMMING

## 3.1 Selection of sensor type

The diagram below shows first the configuration menu of the different sensors types, next step is then going to the run mode selection.

When selecting Contact closure sensor type, anti rebound filter will activate automatically  
Both input channels are programmed automatically for the same type of sensor input.

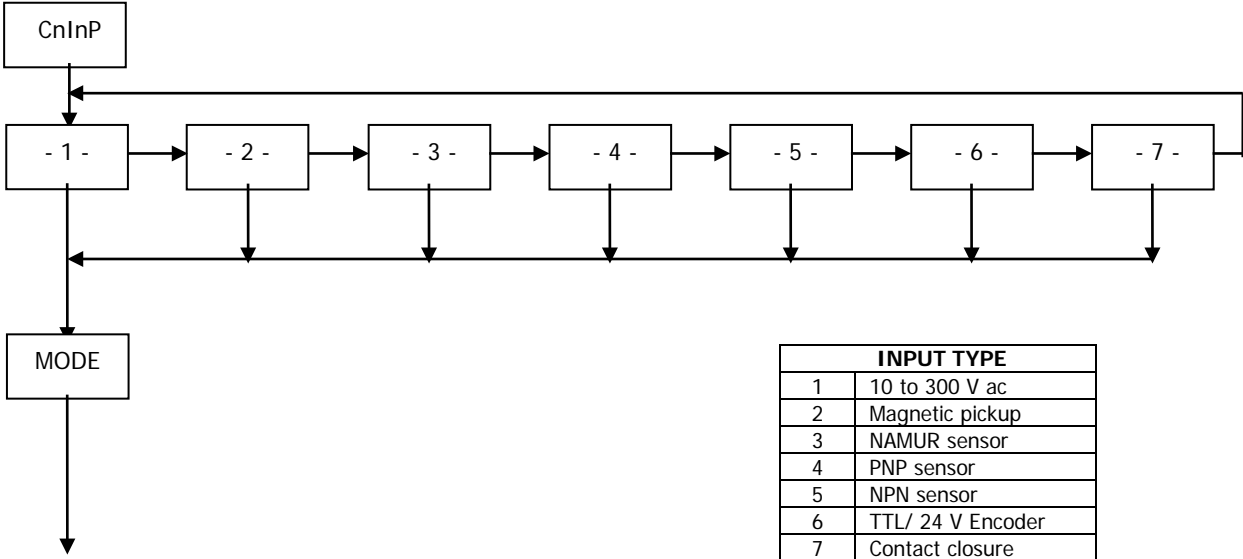

### 3.2 COUNTER mode programming diagram

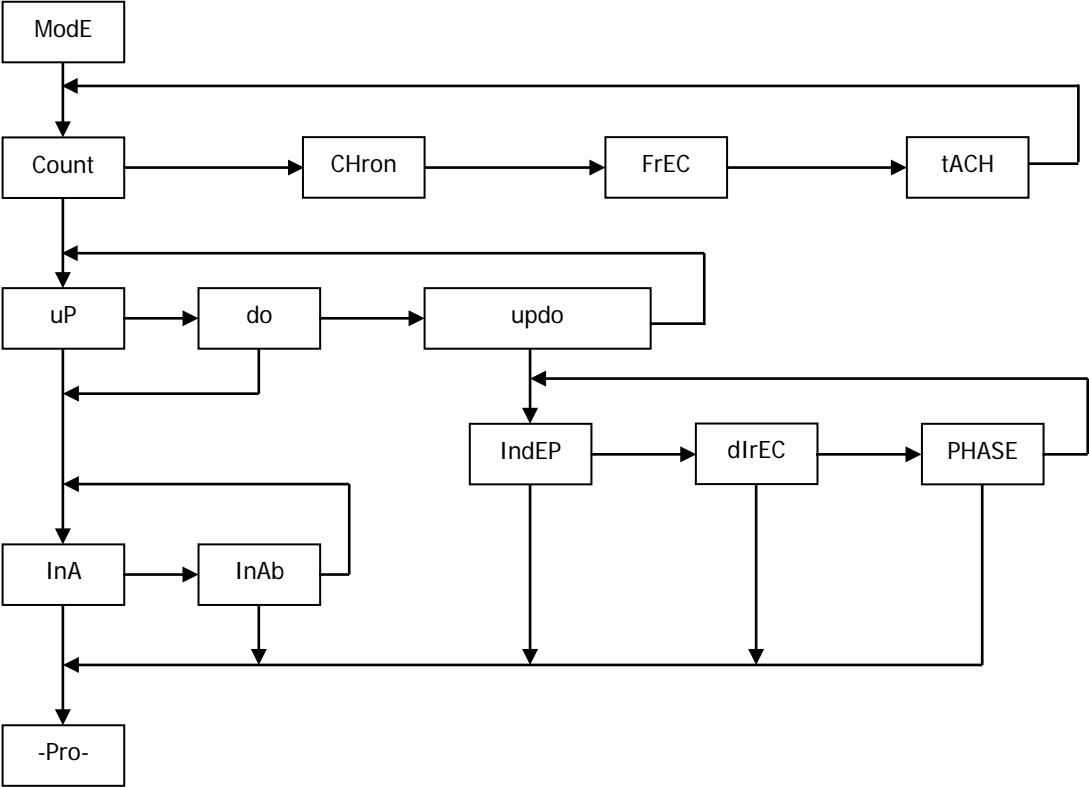

## 3.3 Counter configuration

---

### INPUTS

The counter has two inputs, the A input receives the pulses to count, and the B input serves to inhibit the count or to change the count direction, except in case of bidirectional counter **IndEP** where the second input is also used to count pulses.

### PULSE MEASUREMENT

The pulses applied to the input are detected on the rising edge, except for type **5** (NPN) and type **7** (Free contact) that detect the falling edge, and immediately update the value of the counter and the status of the alarms if existed.

The display refreshes every 100 ms.

In a disconnection of the network, the instrument saves the count value reached internally.

### VARIABLES

The main variable of the counter is the PROCESS variable that is the number of pulses registered from the last RESET operation.

If the totalizer option is enabled, we have PROC and TOTAL variables.

The TOTAL variable counts the total number of pulses received, independently of the reset operations that may take place in the process display.

### DISPLAY

**Process:** The limits of the display are 99999 and -99999. When the instrument exceeds 99999, it shows oVER, and when it falls below -99999, it shows -oVER.

The positive sign is indicated by the red LED Up arrow located on the left side of the display and the negative sign is indicated by the red LED Down arrow located on the left side of the display.

The decimal point can be located in anyone of the digits of the display, and it has not value, that is, the display always shows the whole part of the measurement.

**Total:** The limits of the display are 99999999 and -99999999. When the instrument exceeds these limits the display shows the indications oVER or -oVER.

The negative sign, when the value has less than five digits, appears in the most significant digit of the display. The negative sign is indicated by the MIN LED.

When the total value has more than five digits, the display alternates the 4 digits high order part and the 4 digits low order part (the letters 'H' and 'L' in the auxiliary digit indicate which part is on display).

The decimal point can be located in anyone of the digits of the low part, and it does not have value, the display shows the whole part of the measurement.



### 3.4. Mode count programming

The input setup is available on the 'CnInp' module which allows configuration of the count mode and batch operation.

#### 3.4.1. Count Modes

**uP** : Up count

**do** : Down count

**In-A** : Allows count on A input regardless of input B

**InA-B** : Pulses applied at the A input are added or subtracted to the count display if the B input is at low level and being used as inhibited input

**uP-do IndEP** : Pulses applied at the A input are added to the count display while pulses at the B input are subtracted

**uP-do dIRec** : When B input is at low level, the pulses applied at the A input increment the count. When B input is at high level, the pulses at the A input decrement the count

**uP-do PHASE** : The rising edges at the A input increment the count if the B input is at low level. The falling edges at the A input decrement the count if the B input is at low level.

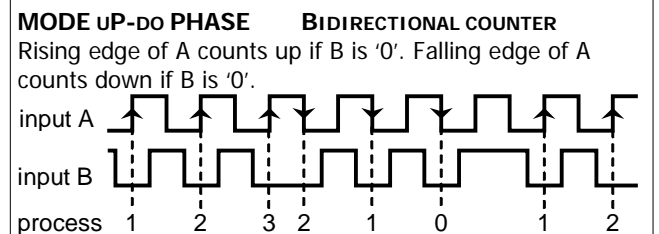
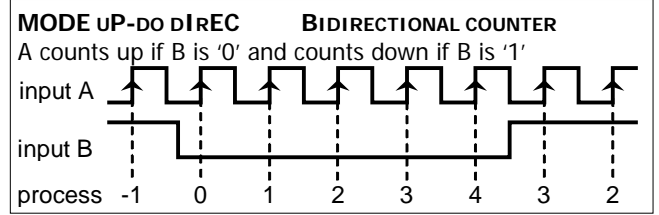
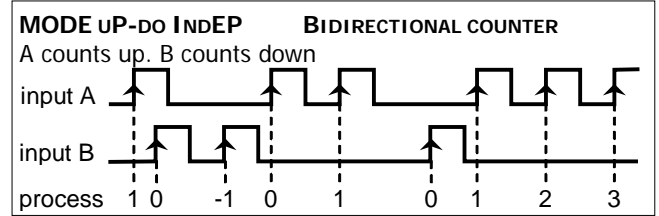
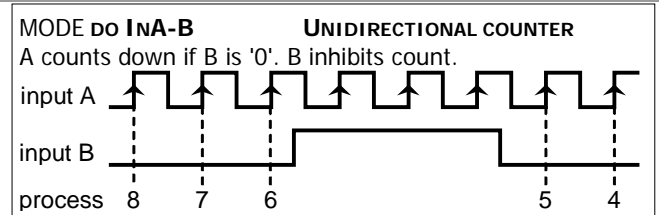
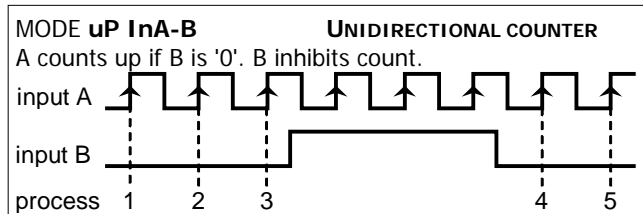

### 3.5. Programming diagram of the DISPLAY in MODE: COUNTER

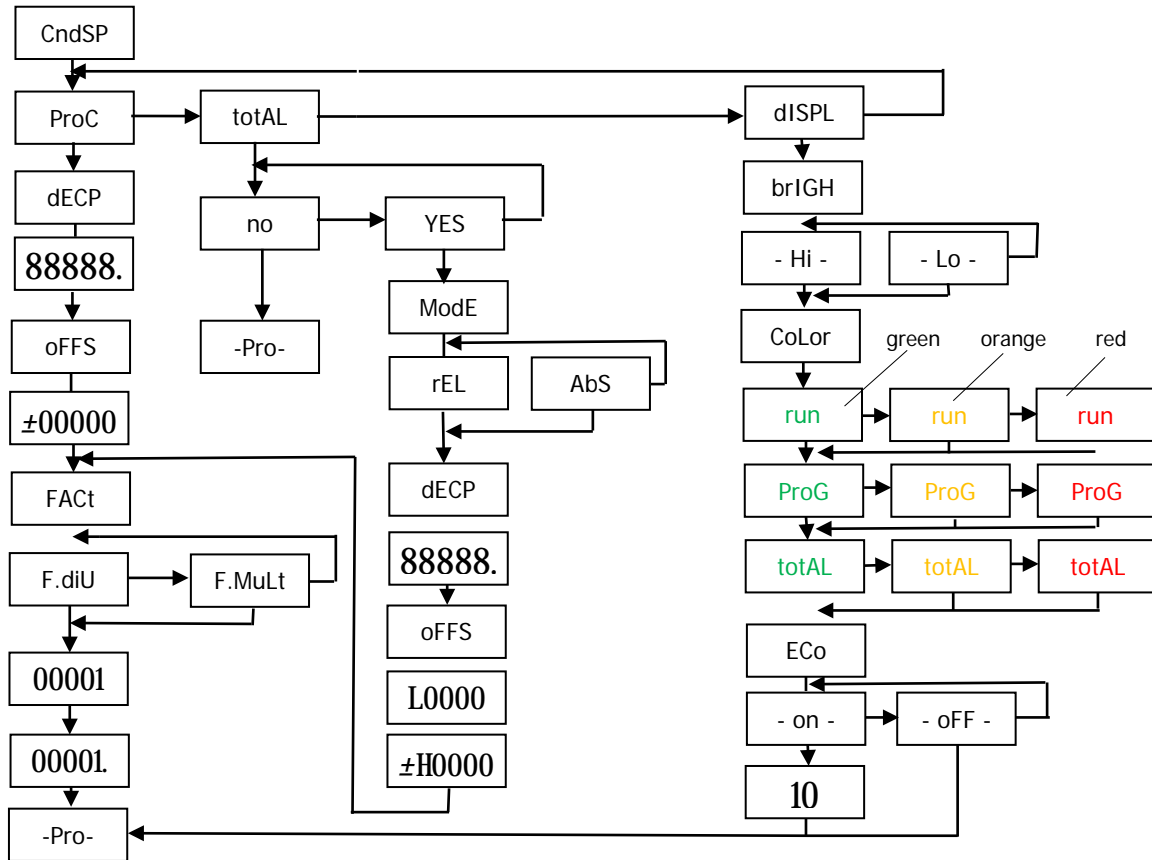

### 3.5.1. Options of the process Variable

#### DECIMAL POINT

The decimal point indication helps to read the display in the desired engineering units.

The decimal point has no real value, i.e. the digits to the right of the decimal point are not actually decimals. To read values with resolution to the desired decimal places is achieved by a combination of decimal point and scaling factor.

For example, suppose a system that provides 100 pulses per 2 meters length of a material. To display length in meters and centimeters, you should program a factor of 2 (1 pulse = 2 cms) and place the decimal point to the third digit.

#### OFFSET

OFFSET is the value that takes the counter in a reset event.

By default it is zero whatever is the configuration.

Configurable in the menu **ProC** and **total**

#### MULTIPLIER / DIVIDER FACTOR

The multiplier factor (**F.MuLt**) or divisor (**F.dIU**) is programmable from 0.0001 to 99999.

(It is not possible to program a factor = 0).

After programming the value including decimals, press  and the intermittent decimal point will appear to place your position on the display.

### 3.5.2. Totalizer option

The totalizer is optional and has a decimal point and multiplying factor independent of the partial counter. The totalizer indication range is from 99999999 to -99999999.

The decimal point has a maximum of five positions, from digit 0 to 4. The multiplying factor is programmed in the same way as that of the partial counter (0.0001 to 99999).

The totalizer has a programmable offset.

The number of inputs, mode and counting direction are those that have been selected for the partial counter. Each pulse increases exactly both counters, although the indication can vary from one to another if the multiplying factor is different.

**Totalizing operating MODES:** relative or absolute

Relative (**rEL**): Same as partial counter operation

Absolute (**Abs**): Always add input impulses

#### VISUALIZATION of the TOTALIZER

Pressing the TOTAL key, if it is activated, will present us with the format indicated below the total value accumulated since the last reset.

### 3.5.3. Display format (TOTALIZER)

When the value does not exceed five digits, the indication is fixed with the sign on the red LED that bears an up arrow for positive and down for negative.

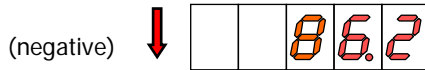
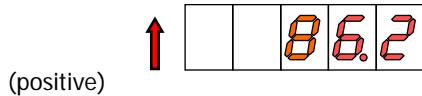

When the accumulated value exceeds from four digits, the display alternates a 4 digit high order part (with the letter 'H' in the auxiliary digit) and a 4 digit low order part (indicated by the letter 'L' in the auxiliary digit).

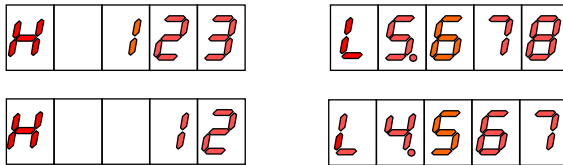

(The switching between high and low order parts takes place at a rate of approximately 2s each part).

#### Presentation programming on display

In the sub-menu (**dISPL**) the following display modes can be selected:

**Brightness: Hi** (normal luminosity) / **Lo** (low luminosity)

**Color:** It is possible to assign a different color to:

**(run)** process display



**(totAL)** display totalizer

**(ProG)** display programming

Selected by the  key the desired color.

**ECO:** In ECO mode the display will turn off in the preset interval for energy saving.

If you select (On) when you press , two digits appear with the time in minutes that it will take the display to go off if you have not acted on any key.

This time can be modified up to 99m with the  and  keys.

To accept the value press  and we will return to PrO

### 3.6. Programming diagram in MODE: CHRONOMETER

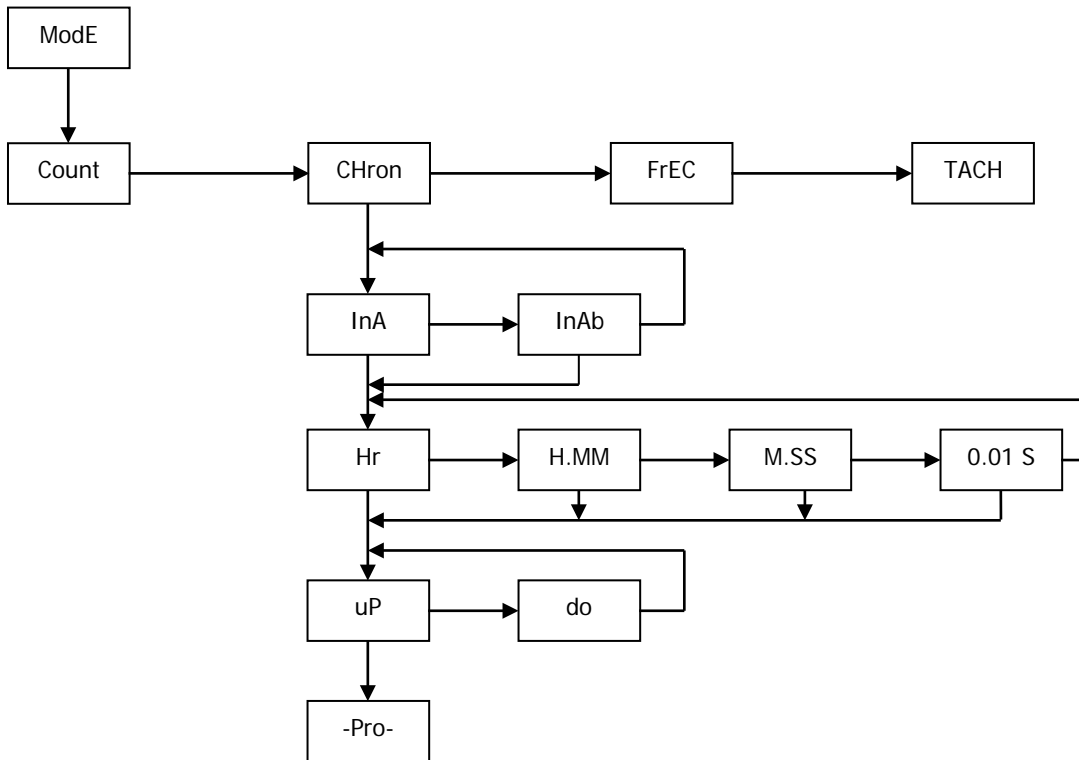

#### DISPLAY programming diagram in CHRONOMETER mode: (see page 18)

Same as COUNTER mode, except that:

- 1- in ProC> neither the decimal point nor the multiplying factor are activated
- 2- in totAL> the sign leds of the offset are not activated
- 3- in totAL> the counting mode rEL / AbS does not appear

## 4. CHRONOMETER CONFIGURATION

---

### INPUTS

The meter has two inputs for the START and STOP signals that provide different types of time measurement according to input setup (see page 23 "Start and Stop Modes").

There are two selectable operating modes:

**mode In-A**, that allows to measure the width of a pulse,

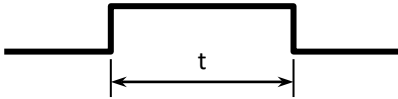

**mode In-AB**, that is used to measure the difference between two signals

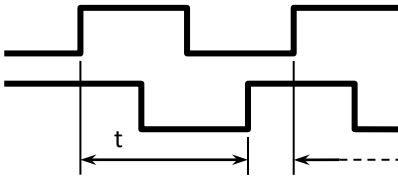

### MEASURE

Time measurement is initiated on a rising edge of the START input. This starts up an internal counter which is controlled by a high precision crystal quartz clock.

The STOP signal suspends the internal count keeping the value of the counter to the START of following time measurement cycle.

The counter is missed to zero in a RESET operation.

In a disconnection from the power source, the instrument saves the count value reached internally.

### DISPLAY

The display can not be scaled, it only reads time in the units selected according to de programmed time range.

The decimal point appears at a fixed position according to time range.

### OFFSET

An offset value can be programmed for example to count down to zero from the preset time value.

The measured value, and the alarms if they exist, is updated in each minimum unit of the selected magnitude.  
Display refreshment: each 100 ms.

## 4.1. Run mode programming

### START AND STOP MODES

**MODE In-A** START on rising edge of input A.  
STOP on falling edge of input A.

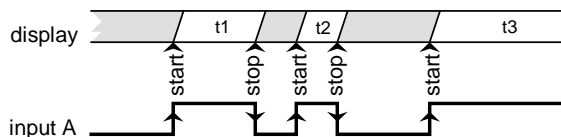

**MODE In-AB** START on rising edge if input A.  
STOP on rising edge of input B.

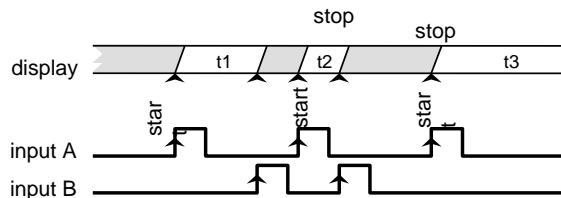

### UP or DOWN DIRECTION

**uP** : The meter acts as a stopwatch. It counts up the time elapsed between the START and STOP signals. When accumulated value exceeds from 99999, the display reads OVER.

**do** : The meter acts as a timer. It counts down from a user programmed offset to zero (a setpoint may be used to perform any function at this point). A reset operation sets the timer to the offset value; the START signal initiates the timing count. When accumulated value reaches 0, the display remains at zero.

### TIME RANGE

There are four selectable time ranges:

**Hr** 99999 h (hours)  
**H.MM** 999 h 59 m (hours and minutes)  
**M.SS** 999 m 59 s (minutes and seconds)  
**0.01-S** 999.99 s (seconds with hundredths)

The decimal point appears in the position according to the programmed time range.  
 (In a power failure, the meter saves the time value and the internal count value).

In a scale change or power failure, the indicator saves the value registered on the display and also the fraction of time that was accumulated internally with the following resolutions:

<b>Hr</b>	1 second
<b>H.MM</b>	1 second
<b>M.SS</b>	0.1 second
<b>0.01-S</b>	0.01 second

## 5. FREQUENCY METER / TACHOMETER CONFIGURATION

### INPUTS

In frequency/tachometer mode both inputs of the meter are used. The signal providing frequency/rate and count information must be issued to the A input. A second signal may be applied to the B input to control direction of rotation or polarity of the signal.

### MEASURE

The method of calculating rate is based in measuring the period of the signal, that is, the time elapsed between two consecutive rising edges. The period is converted into a high precision frequency value and scaled to read desired units.

### DISPLAY

The meter allows the user to change some parameters to fit the particular application needs, such as to reduce or extend the number of signal cycles of each reading, the time limit, the display rate and averaging (see "Options of the Process Variable" in pages 30 and 31).

### TOTALIZER

If enabled, the totalizer accumulates the number of pulses received at the input providing two simultaneous information for example flow rate and product quantity for a given process.

### DIRECTION OF ROTATION INDICATION

Direction sensing indication is a matter of simply setting the totalizer to read UP/DOWN direction (modes PHASE and dIrEC).

The direction of rotation is denoted by the LED's MAX and MIN on the left of the display. LED MAX illuminates when the totalizer counts in the up direction, so it can be associated to a "positive" rate.

LED MIN illuminates when the totalizer counts down, which may be associated to a "negative" rate.

A change in the polarity of rate is recognized when the meter receives at least two consecutive pulses in the opposite direction of the one of the previous pulses.



Programming diagram for MODE: FREQUENCYMETER/ TACHOMETER

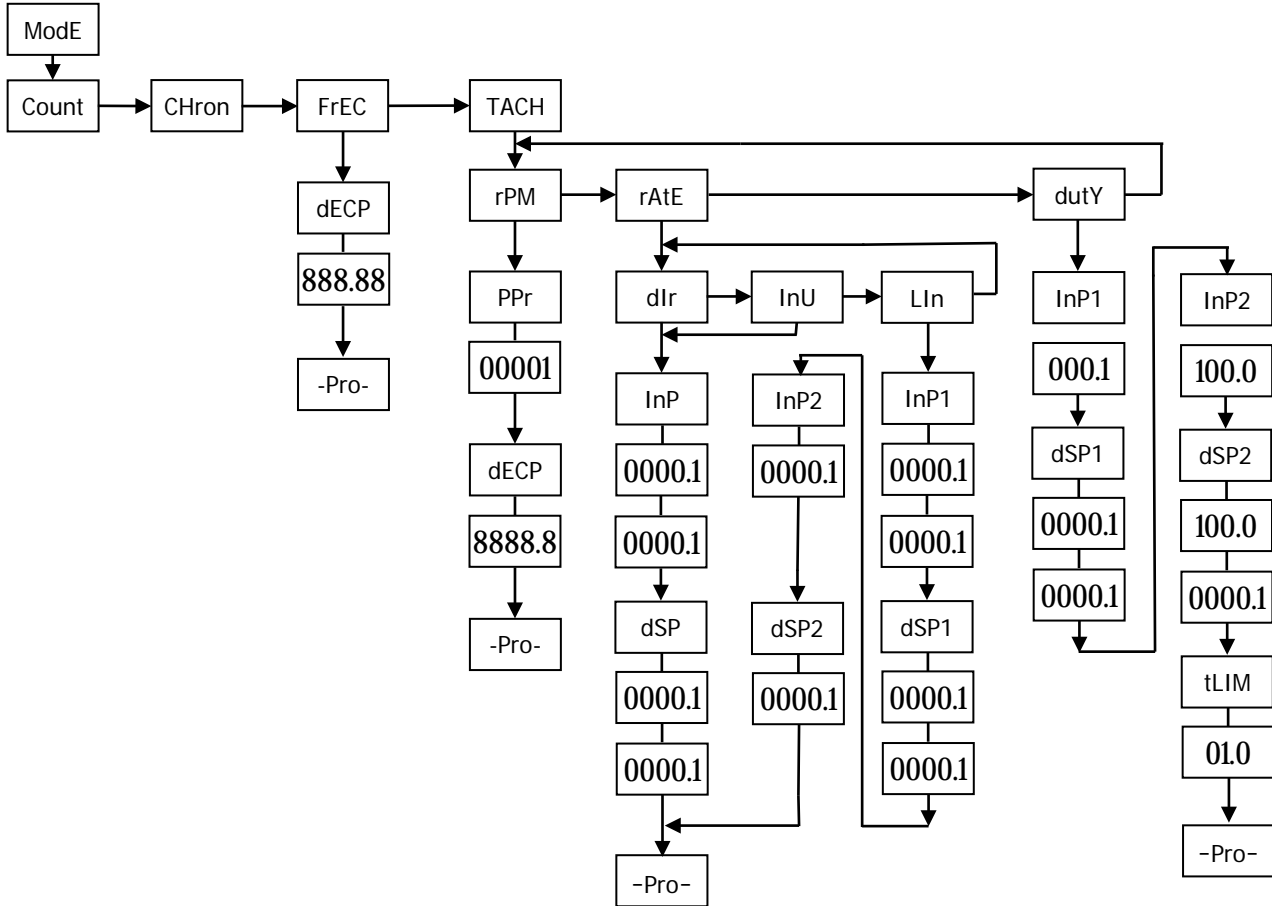

## 5.1. Frequencymeter/ Tachometer

---

### CONFIGURATIONS

#### 5.1.1. FREQUENCYMETER

To use this instrument as frequency indicator, select directly the frequencymeter input.

#### DECIMAL POINT

The only parameter to select in this input menu is the position of the decimal point, which can be 0, 1 or 2.

#### 5.1.2. TACHOMETER RPM

It is an indicator of angular speed expressed in revolutions per minute. The parameters to enter are the number of pulses per revolution and the decimal point.

#### PPR (PULSES PER REVOLUTION)

As PPR, the actual number of pulses provided by the sensor must be programmed in one complete revolution.

#### DECIMAL POINT

The decimal point to be programmed in this step is the one that will be displayed which, combined with the multiplier / divider factor, will allow the indication in units other than rpm, if necessary.

#### 5.1.3. TACHOMETER RATE

In the RATE configuration, the tachometer can be scaled to read speed, flow or time directly in the desired units, by entering two parameters: Input Frequency and Desired Display.

#### SELECT SCALE DIRECT, REVERSE OR LINEAR

**Direct scaling.** The frequency-display relationship is directly proportional, that is, the higher the frequency, the greater the display and the lower the frequency the lower the display.

**Reversed scaling.** The frequency-display relationship is inversely proportional, that is, the higher frequency the smaller the display and vice versa. A typical application of this option is explained in the example on p. 27.

**Linear scaling.** The scale is defined between two points, therefore it does not necessarily pass by zero.

**INPUT FREQUENCY.** For scaling purposes, the input frequency can be any value within the display range (the actual frequency limits are given on page 56 of this document).

The decimal point can be placed in the digit 0, 1 or 2.

**DESIRED DISPLAY.** The value to be programmed in this step is the display value corresponding to the frequency programmed in the previous step. The decimal point can be placed in any of the digits of the display to facilitate reading in the desired units.

## EXAMPLE OF SCALING IN RATE MODE

*Loaves of bread are transported in a conveyor belt and introduced in a continuous baking oven. The belt is attached to a turning shaft of 20cms that gives 6 pulses per revolution. The average time necessary for a loaf to be baked is 15min and 30s and it has been determined that, to achieve this time, the rate of the turning shaft must be kept to 300rpm.*

*This example allows exposing some capabilities of the rate meter configuration.*

The rate of the turning shaft is 300 revolutions per minute, which is equal to 5 revolutions per second.

*If the turning shaft makes 5 complete revolutions in one second and each revolution drives out 6 pulses, the total number of pulses per second is 30. The input frequency is then 30Hz.*

### Rate of the conveyor belt (m/s)

The rate of the conveyor belt at the specified frequency is:

$\text{rpm} * \pi * \text{diameter} = 300 * \pi * 20 = 18849.6 \text{ cm/min}$   
which is in m/s, 3.142m/s.

PARAMETERS TO PROGRAM:

RATE MODE:	<b>DIRECT</b>
INPUT FREQUENCY:	<b>30</b>
DESIRED DISPLAY:	<b>03142</b>
DECIMAL POINT:	<b>03.142</b>

### Baking Time (min)

It is required to monitor the baking time knowing that, at the specified frequency of 30Hz, the time taken for each loaf to be baked is 15min 30s.

*When rate (and frequency) grows, the baking time is reduced proportionally. The rate meter must then be programmed for reverse mode.*

PARAMETERS TO PROGRAM:

RATE MODE:	<b>INVERSE</b>
INPUT FREQUENCY:	<b>30</b>
DESIRED DISPLAY:	<b>00155</b>
DECIMAL POINT:	<b>0015.5 (min)</b>

The time values must be programmed in decimal notation.

In the preceding example, a baking time of 15min 30s has been introduced as a display value of 15.5 (15 minutes and a half).

### Daily Production (loaves/day)

It has been determined that, in the specified conditions, the bread loaves are baked at an average of 10 loaves per minute. The baking oven works 12 hour per day and it is required to monitor the production of loaves per day.

Ten loaves per minute is equivalent to  $10 \times 60 = 600$  loaves per hour.

At a frequency of 30Hz, the daily production is  $600 \times 24 = 14400$  loaves/day.

PARAMETERS TO PROGRAM:

RATE MODE:	<b>DIRECT</b>
INPUT FREQUENCY:	<b>30</b>
DESIRED DISPLAY:	<b>14400</b>
DECIMAL POINT:	<b>NO</b>

#### 5.1.4. TACHOMETER DUTY (PWM)

In the DUTY configuration, the tachometer is able to present a display proportional to the cyclic relationship of the input signal (t on / t off)

##### Duty Mode Programming

The programming sequence is similar to that of any analog input, introducing a pair of values for the input (InP1 and InP2) to which correspond a pair of display values (dSP1 and dSP2).

InP1 = Ton / toff value in point 1 (programmable from 0 to 100.0%)

dSP1 = Display value for point 1 (programmable from 0 to 99999 plus decimal point position)

InP2 = Value of ton / toff in point 2 (programmable from 0 to 100.0%)

dSP2 = Display value for point 2 (programmable from 0 to 99999)

Modulation of the cyclical relationship (duty cycle)

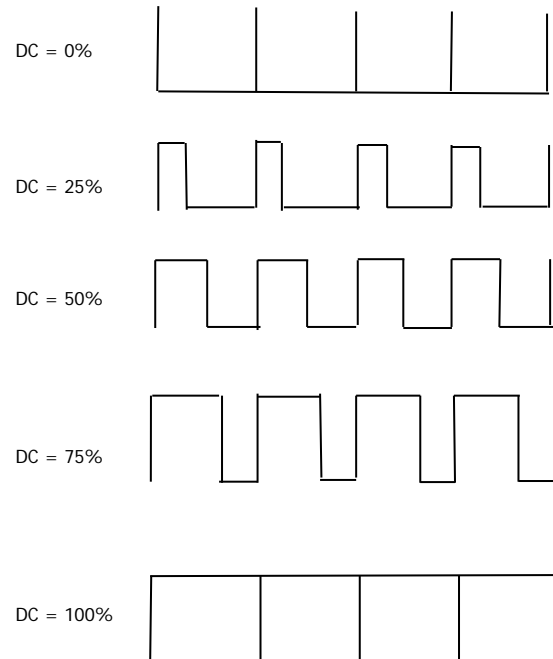

## 5.2. Display Programming MODE: FREQUENCYMETRE / TACHOMETRE

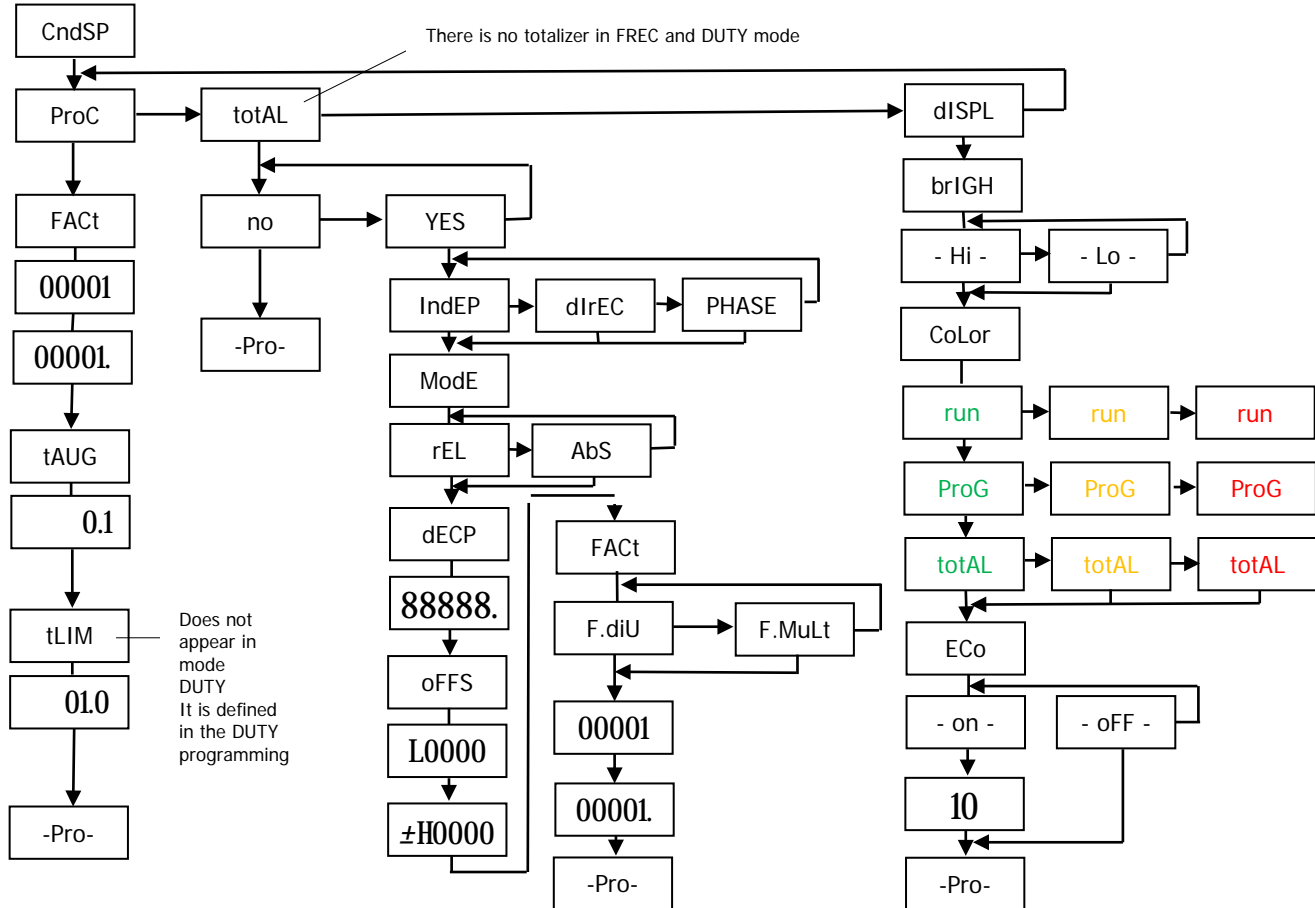

### 5.2.1. Option of process variable

The menu **ProC** in the module **CndSP** contains various parameters for scaling and filtering the display -Scale Factor, Max and Min Times, Averaging-

#### SCALE FACTOR (FACT)

The scale factor is programmable between 0.0001 and 99999 and multiplies or divides depending on if it is higher or lower than 1.

#### TIME LIMIT (tLIM)

The time limit, programmable from 1 to 99.9 seconds, is the amount of time that the meter waits for at least one pulse is produced at the input before it is considered to be zero.

**The time limit is initialized at the reception of each input pulse. If no more pulses are detected before the time limit runs out, the display is forced to zero.**

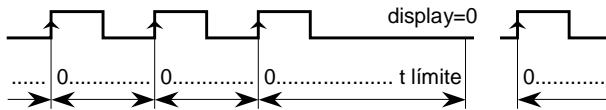

Decreasing the limit time makes the instrument respond more quickly to the zero condition when the system stops.

Nevertheless, this reduction also will cut the lowest frequencies (for example: with a time limit of 10s, it would be impossible to see frequencies under 0.1Hz and with a time of 1s, frequencies under 1Hz).

### AVERAGE TIME (tAVG)

The instrument can display all the readings at a rate of 10 per second (the display refreshes every 100ms) or an average of the readings made during a programmable time: the AVERAGE TIME.

The average time is programmable from 0 to 9.9 seconds. To disable this feature program 0.

When the display presents unwanted variations, due to that the input signal is not regular, the programming of the average time for a larger value may help stabilize the display.

The average time can be calculated for a desired number of readings knowing the signal frequency.

Example: With a setup of 0.1s, if the input signal frequency is of approx. 10Hz or less, the meter will only take one reading per each 0.1s making no average. With an input signal of approx. 100Hz, the meter will be able to collect and average about 10 readings in 0.1s. If the input signal is of approx. 1000Hz, the display will read out the average of about 100 readings

**IMPORTANT: To have direction of rotation indication, it is necessary to activate the totalizer (option YES in total)**

The positive sign indication occurs when the pulses that are applied to the device cause an increase in the counter, and the negative sign when the counter is decremented.

A change of direction of rotation is materialized in the display, that is, the MAX and MIN LEDs are exchanged, when at least two consecutive pulses are produced in the opposite direction to that indicated by the previous pulses.

#### **DECIMAL POINT**

The situation of the decimal point facilitates the reading of the display in the desired engineering variables.

Its position has no value, that is, the digits to the right of the decimal are not, in principle, decimals, although it is possible to combine multiplying factor and decimal point of the display to obtain fractional measures.

#### **MULTIPLIER / DIVIDER FACTOR**

The multiplier / divider factor is programmable from 0.0001 to 99999. It has its own decimal point, which makes it possible to program any value within that range regardless of the position of the decimal on the display.

When the factor is less than zero, it acts as a divisor, while if it is higher, it acts as a multiplier.

#### **RESET KEY**

The RESET key allows, in **Tachometer** mode, setting the Max and Min memories to the current value.

To set the MAX or MIN value to the current value, the value you want to reset must be showed on display and pressing on the reset key will erase this value.

To reset the **totalizer** it is necessary to recall the TOTAL variable on display pressing TOTAL key and then press RESET.

Clear to zero the variable present on display is carried out when releasing the RESET key; being then reinitiated the count, in **counter** mode or **chronometer**, from zero or offset.

**The RESET key will not operate if in the program lock-out routine its corresponding step is activated.**

#### **5.2.2 TOTAL, MAX and MIN Visualization**

In **tachometer mode** one push on the MAX/ MIN key shows, when activated, the total value in the programmed color; next push shows the peak value with the flashing led MAX indicator; next push shows the valley value with the flashing led MIN indicator; another push brings us back to current value indication.

## 6 – LOGIC FUNCTIONS

The rear connector CN3 provides 3 user programmable opto-coupled inputs that can be operated from external contacts or logic levels supplied by an electronic system. Three different functions may be added to the functions available from the front-panel keys. Each function is associated to one pin (PIN 2, PIN 3, PIN 4) and is activated by applying a falling edge or a low level pulse to the corresponding pin with respect to common (PIN 1).

Each pin can be assigned one of the 13 functions listed on the following pages.

- Factory configuration

Functions associated to Connector CN3 in factory configuration are: RESET PROCESS, RESET TOTALIZER and HOLD.

### CN3: FACTORY CONFIGURATION

PIN (INPUT)	Function	Number
PIN 1	COMMON	
PIN 2 (INP-1)	RESET PROCESS	Function n° 3 – (ProC)
PIN 3 (INP-2)	RESET TOTALIZER	Function n° 3 – (totAL)
PIN 4 (INP-3)	HOLD DISPLAY	Function n° 6

Logic functions diagram

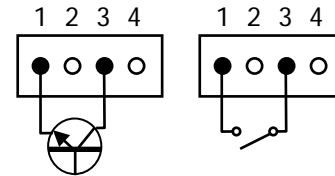

The external electronics applied to the CN3 connector must be capable of withstanding 40 V and 20 mA present at all terminals with respect to COMMON. In order to guarantee the electromagnetic compatibility, please refer to the instructions given on page 9.

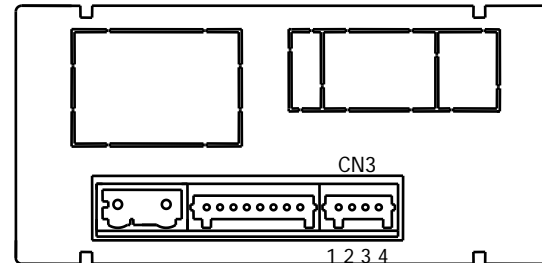



## 6.1.1 – Logic functions diagram

### 6.1 – Programmable functions table

- **N°:** Number to select the function via software.
- **Function:** function name.
- **Description:** Function operation and characteristics.
- **Activation by :**

Falling edge: the function is activated applying a falling edge to the corresponding pin with respect to common.

Low level: The function will remain activated as long as the corresponding pin is held at a low level.

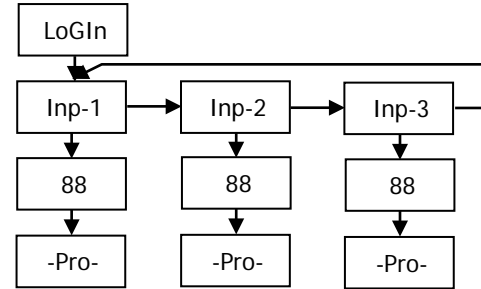

N°	Function	Description	Activation by
0	Deactivated	None	None
1	OFFSET	Take the value of the display as offset	Falling edge
2	RESET OFFSET	Reset the offset memory	Falling edge
3	RESET VARIABLES	Resets the value of the variable (ProC, totAL, PEAK, VAL)	Falling edge
4	SEE VARIABLES	Displays the value of the variable (ProC, totAL, PEAK, VAL)	Low level
5	PRINT VARIABLES	Send in ASCII the value of the variable (ProC, totAL, PEAK, VAL, OFFSEt, SEt1, Set2, Set3, Set4)	Falling edge
6	HOLD DISPLAY	Fix the display value	Low level
7	BRIGHTNESS	Changes the brightness of the display alternating between Hi and Lo	Low level
8	COLOR	Change the color of the display (RED, GREEN, ORANGE)	Low level
9	SETPOINT/OFFSET VALUE	Presents the value to program in (OFFSEt, SEt1, SEt2, SEt3, SEt4) <i>In this mode, the input also acts as an ENTER key</i>	Falling edge
10	FALSE SETPOINTS	Simulates that the instrument has an option of 4 setpoints installed	Low level
11	REMOTE KEYBOARD	InP1 = ENTER, InP2 = SHIFT, InP3 = UP	Low level
12	START / STOP	Start / Stop Chronometer in A mode, or Stop Counter / Totalizer	Low level

## 6.2 – Program of functions

Once the user has accessed the menu of logic functions configuration, he can select, by pressing the  key, a function among those of the table.

Example: FD6200 with value of 1234.5

Message in Hexadecimal sent from the FD6200 RS4 output when logic function 5 is activated.

With *FFd-L* the chain of characters is: **0x18, 0x23, "01", 0x0D, "ProC: +1234.5", 0x0D**

The **FD6200** has to be programmed to work under protocol ASCII (Prt1) y (dLY 1).

See Page 47

Example ticket without date using printer

**#01  
ProC: +1234.5**

If the selected function is number 03, it will give us to choose the value of the variable to reset.

We can assign another digital input to the same function but that acts on another variable, as has been done in the Factory programming: InP1 = Reset PROCESS, InP2 = reset TOTALIZER

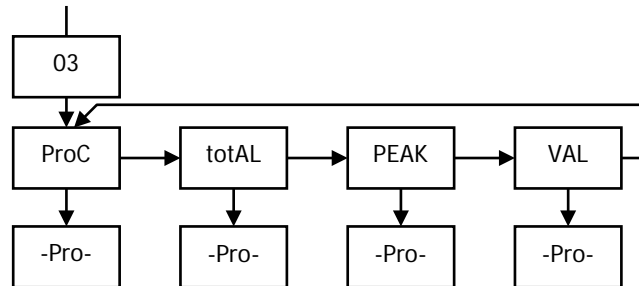

## 7. PROGRAM PARAMETERS AND KEYBOARD FUNCTIONS LOCK-OUT

The instrument is supplied with all software programming parameters accessible to operator's modifications. After completing the software configuration, it is recommended to protect configuration settings by the following steps:

1. Lockout programming parameters to prevent from accidental or unauthorized modifications.
2. Lockout keyboard functions to prevent from accidental or unauthorized modifications.
3. There are two modes to lock-out the program parameters; total or selective. If some parts of the program have to be adjusted at a later time, make a selective lock. If you don't need to make changes, make a total lock.
4. The access to the lockout routine is allowed by entering a safety code. At factory this code is set to **0000**. We recommend changing this code, to write it down and keep in a safe place.

### TOTAL LOCKOUT

The access to the programming routines to read data is allowed even if all parameters are locked out totLC=1, but **it will not be possible to enter or modify data**. In this case, when entering in the programming mode, the display shows the indication "-dAtA-".

### SELECTIVE LOCKOUT

When only some parameters are locked out, all configuration data can be read but **only non-protected parameters can be modified**. In such case, when entering in the programming mode, the display shows the indication -Pro-.

Menus or submenus that can be locked out are:

- Setpoint 1 configuration (SEt 1).
- Setpoint 2 configuration (SEt 2).
- Setpoint 3 configuration (SEt 3).
- Setpoint 4 configuration (SEt 4).
- Input configuration (InPut).
- Display (dSP)
- Color programming on display (CoLor).
- Direct access to the programming of the Setpoints (SPUAL).
- Analog output configuration (Anout).
- Serial output configuration (rSout) or Ethernet (EtnEt).
- Logic inputs configuration (LoGIn).
- Reset of the process variable (rES P)..
- Reset of the variable Totalizer (rES t)
- Peak and Valley Values (MAHMn).

The first four and "SPUAL" only appear if the corresponding option 2RE, 4RE, 4OP ó 4OPP has been installed, "Anout" will appear when any of the NMA or NMV options are installed, and "rSout" when any of the RS2 or RS4 options are installed.

## 7.1 – Security menu diagram

The following figure shows the security menu. In this menu is configured the programming lockout. The access to this menu is accomplished from the run mode by pressing the  key during 3 seconds, until the "CodE" indication appears.

The instrument is shipped from factory with the following default code: "0000". Once entered this code, the "LISt" indication will appear, from which we will enter in the parameters lockout. Acceding to the "CHAnG" menu will allow us to enter a personal code, that we have to write down and keep in a safe place (**Do not count on your memory**). This personal code makes the default code useless.

If an incorrect code is entered, the instrument will return automatically to the run mode.

Total lockout programming is achieved changing to 1 the "totLC" variable, changing it to 0, will lead to the selective lockout of the programming variables. Programming each one of the parameters to 1 will active the lockout, if they are set to 0 programming will be accessible. Though the programming is locked out, it remains possible to visualise the current programming.

The "StorE" indication informs that the modifications effectuated have been stored correctly.

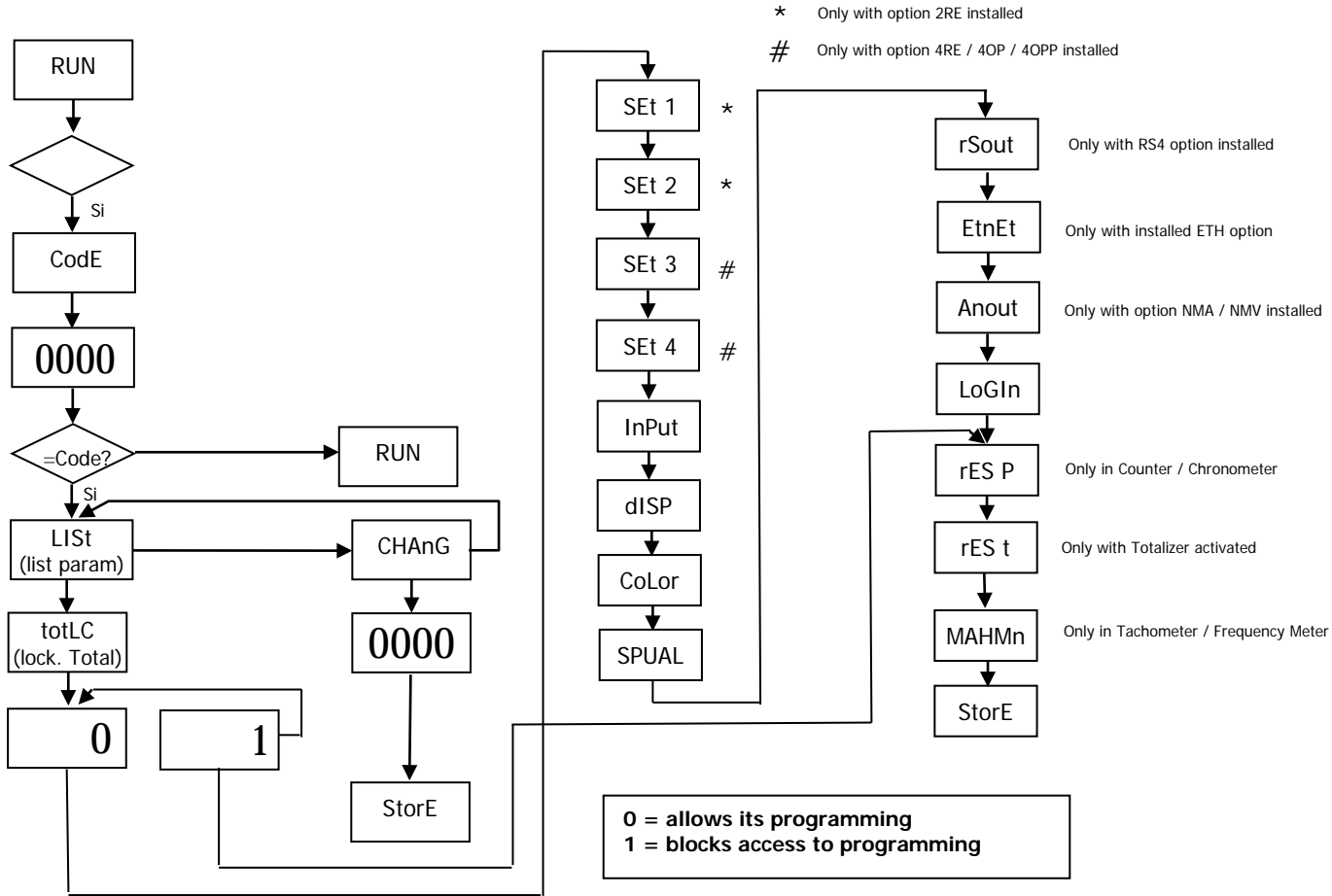

## 7.2- RESTORATION OF FACTORY CONFIGURATION

Following the herewith diagram, factory configuration can be restored:

**CnInP** = - 6- , Encoder /TTL, Count, uP-do, PHASE.

**CndSP** = ProC without decimal; offset=0, multiplying factor= 1, without decimal;

Tot YES, without decimal, multiplying factor= 1, without decimal

**Setpoint 1**= on, ProC=1000, mode=1, latch, alarm= red,

Tot=1000, mode=1, latch, alarm= red,

**Setpoint 2, 3, 4** same as Sepoint 1 but setpoint value to 2000, 3000 and 4000.

**Anout** = outHI= 1000, outLo=0000

**rSout** = Baud 9600, Adr= 01, trans= Prt 2

**LoGIn** = InP-1=1, InP-2=2, InP-3=6

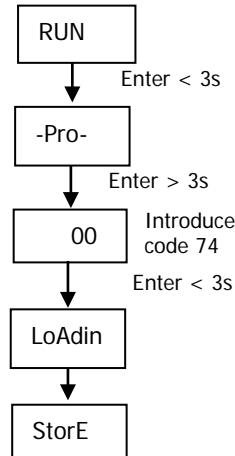

## 8. DIRECT ACCESS TO SETPOINTS

If any of the options corresponding to the setpoints has been installed, it is possible to accede directly to the setpoints value without need to go through the programming menu just by pressing the  key in PROG mode, as showed in diagram below

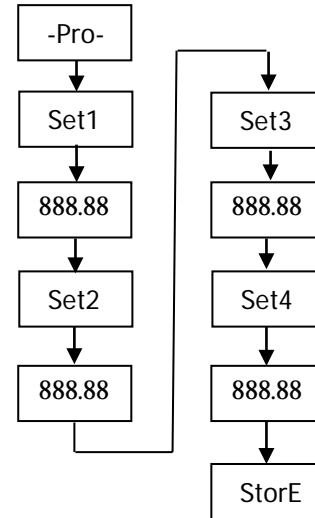

Remember that the position of the decimal point is fixed by the one programmed in the SCAL menu.

## 9. OUTPUT OPTIONS

Optionally, model FD6200 V2.0 can incorporate one or several output options for control or communication:

### Communication options

<b>RS2</b>	Serial RS232C
<b>RS4</b>	Serial RS485
<b>ETH</b>	Ethernet

### Control options

<b>NMA</b>	Analog 4-20 mA
<b>NMV</b>	Analog 0-10 V
<b>2RE</b>	2 Relays SPDT 8 A
<b>4RE</b>	4 Relays SPST 5 A
<b>4OP</b>	4 NPN outputs
<b>4OPP</b>	4 PNP outputs

All mentioned options are opto-isolated with respect to input signal and power supply.

The output cards are easily installed on the meter's main board by means of plug-in connectors and each one activates its own programming modules that provides complete software configuration.

Additional capabilities of the unit with output options:

- Control and processing of limit values via ON/OFF logic outputs or proportional output (4-20mA, 0-10V).
- Communication, data transmission and remote programming via serial interface.

For more detailed information on characteristics and mounting, please refer to the specific manual supplied with each option.

The following figure shows the location of the different outputs options.

The **2RE**, **4RE**, **4OP** y **4OPP** options are alternative and only one of them can be placed into the connector M1.

The **RS2**, **RS4** and **ETH** options are also alternative and only one of them can be placed into the connector M2

The **NMA** or **NMV** option is placed into the connector M3.

Up to three output options can be present at the same time and operate simultaneously:

- One analog (ref. **NMA** or ref **NMV**)
- One RS232C (ref. **RS2**) or RS485 (ref. **RS4**) or Ethernet (ref. **ETH**).
- One 2 relays (ref. **2RE**) or 4 relays (ref. **4RE**) or 4 NPN (ref. **4OP**) or 4 PNP (ref. **4OPP**) outputs.

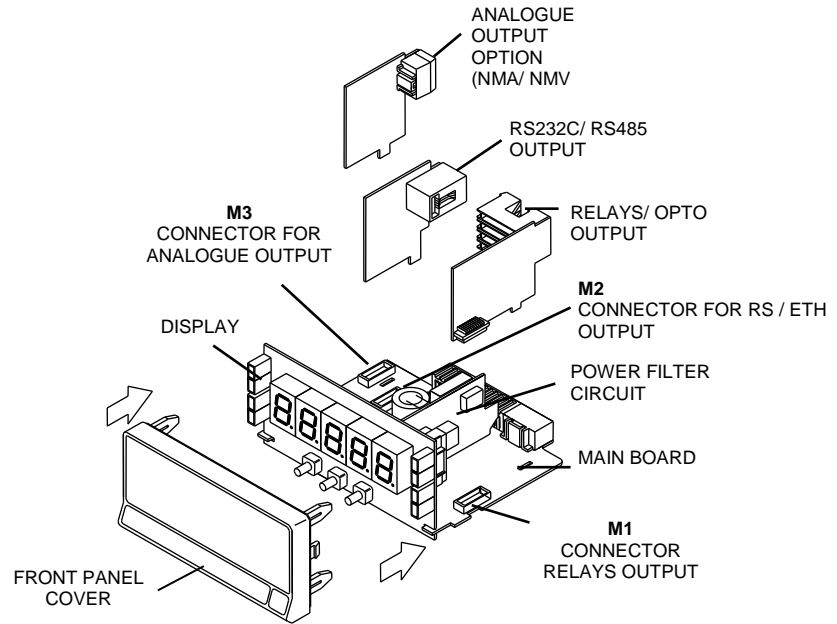



## 9.1 – Setpoints output

### 9.1.1 – Introduction

An option of 2 or 4 SETPOINTS, programmable within the full display range, can be incorporated to the unit thus providing alarm and control capabilities by means of individual LED indicators and relay or transistor outputs. All the setpoints provide independently programmable value, time delay (in seconds), asymmetrical hysteresis (in counts of display) and selectable HI/LO acting.

The setpoint option consists of a plug-in additional card that once installed to the meter's main board, activates its own programming module, they are totally configurable by the user and their access can be locked out via software.

These are the control output options available:

**2RE:** 2 Relays SPDT 8 A

**4RE:** 4 Relays SPST 5 A

**4OP:** 4 NPN outputs

**4OPP:** 4 PNP outputs

These types of outputs, capable of carrying out a wide variety of control operations and processing of limit values, increases notably the unit's performance qualities thanks to the possibility of combining basic alarm functions with advanced safety and control applications.

### 9.1.2 – Installation

Lift out the electronics assembly from the case and use a screw-driver to push on the junctions between the case and the shadow areas to detach them from the case. See fig. The so performed orifice will allow any of the setpoints (2RE, 4RE, 4OP or 4OPP) board output connectors be brought out at the rear of the instrument. The option is installed by plugging the connector in the main board location. Insert the card pin in the corresponding main board slot and push down to attach both connectors.

If the instrument is to be installed in high vibrating environments, it is recommended to solder the card to the main board making use of the copper tracks on both sides of the card pin and around the main board hole on its solder side.

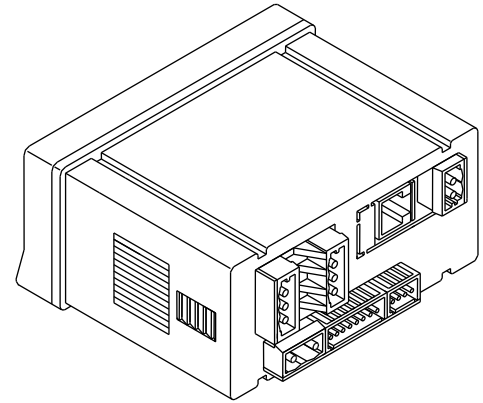

### 9.1.3 – Wiring

#### 2RE - 2 RELAYS OPTION

PIN 4 = NO2    PIN 1 = NO1  
 PIN 5 = COMM2    PIN 2 = COMM1  
 PIN 6 = NC2    PIN 3 = NC1

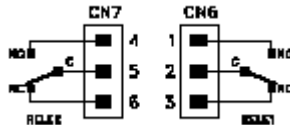

#### 4OP - OPTION 4 OPTOS NPN

PIN 4 = OP4    PIN 1 = OP1  
 PIN 5 = N/C    PIN 2 = OP2  
 PIN 6 = COMM    PIN 3 = OP3

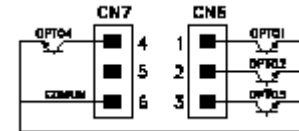

#### 4RE - 4 RELAYS OPTION

PIN 4 = RL4    PIN 1 = RL1  
 PIN 5 = N/C    PIN 2 = RL2  
 PIN 6 = COMM    PIN 3 = RL3

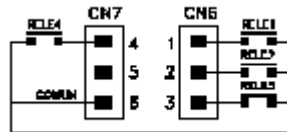

#### 4OPP – OPTION 4 OPTOS PNP

PIN 4 = OP4    PIN 1 = OP1  
 PIN 5 = N/C    PIN 2 = OP2  
 PIN 6 = COMM    PIN 3 = OP3

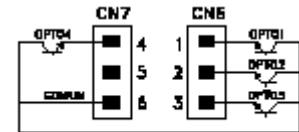

Each output card is supplied with an adhesive label that indicates the wiring connections of each option. To help identifying each terminal, this label should be placed in the lower side of the meter case, beside the basic functions label.

**NOTE:** In case that the outputs are used to drive inductive loads, it is recommended to add an RC network between the coil terminals (preferably) or between the relay contacts to limit electromagnetic effects.

### 9.1.4 – technical specifications

<b>CHARACTERISTICS</b>	<b>2RE OPTION</b>	<b>4RE OPTION</b>
MAX.CURRENT(RESISTIVE LOAD) .....	8 A .....	5 A .....
MAX.POWER .....	2000 VA / 192 W .....	1250 VA / 150 W .....
MAX.VOLTAGE.....	250 VAC / 150 VDC .....	277 VAC / 125 VDC .....
CONTACT RESISTANCE .....	Max. 3mΩ .....	Max. 30mΩ .....
SWITCHING TIME.....	Max. 10ms .....	Máx. 10ms .....

#### **4OP and 4OPP OPTION**

MAX VOLTAGE.....	50 VDC
MAX CURRENT .....	50 mA
LEAKAGE CURRENT .....	100 μA (max.)
SWITCHING TIME.....	1 ms (max.)

### 9.1.5 - Setpoints menu diagram in mode Frequencymer / Tachometer

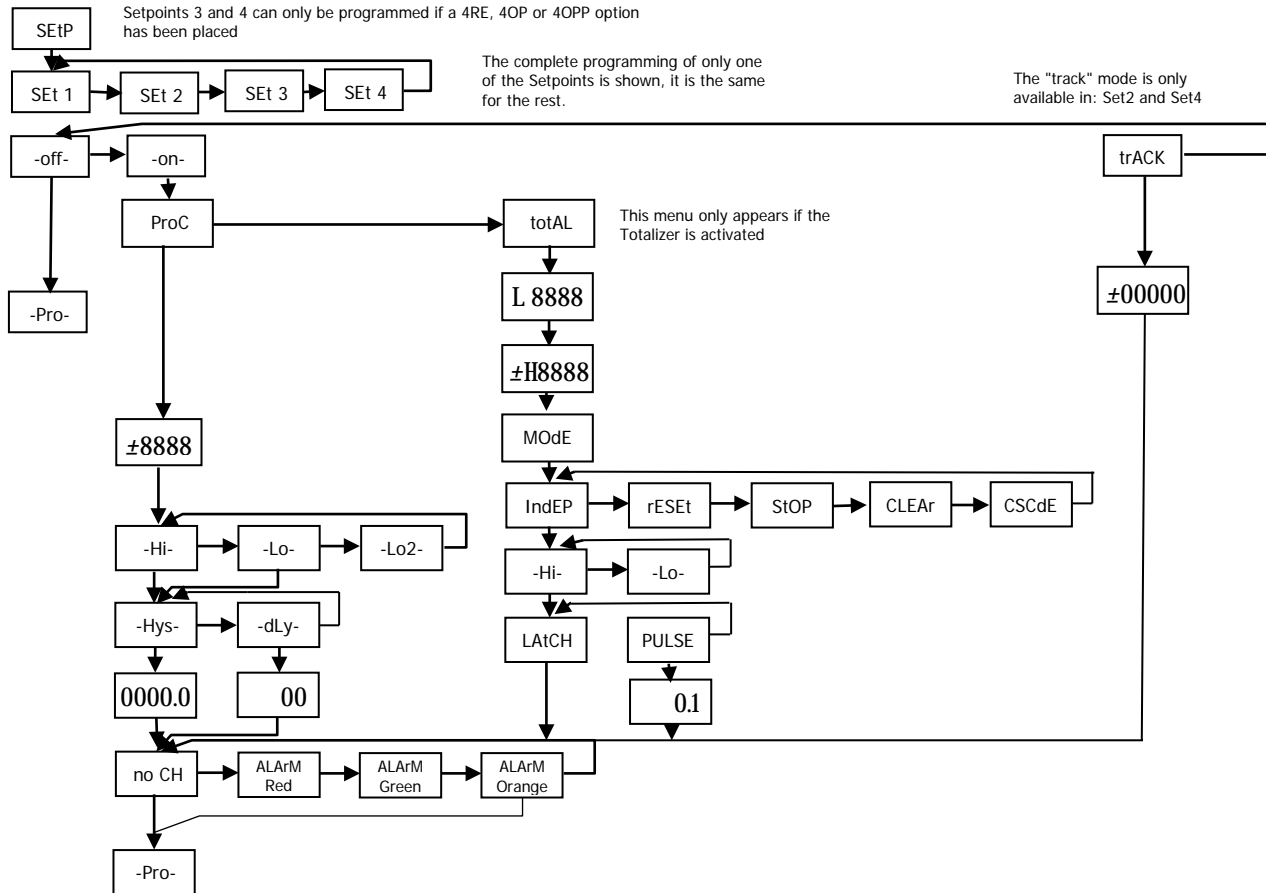

### 9.1.6 – Description of operation in Frequencymeter, Tachometer mode.

As programmed like independent setpoints, the alarm outputs activate when the display value reaches the user-programmed value. The independent alarms programming requires definition of the following basic parameters:

- **HI/ LO / LO2 ACTING MODE:** In HI mode, the output activates when the display value exceeds the setpoint level and in LO mode, the output activates when the display value falls below the setpoint, in LO2 mode it avoids that during the power-up it enters with the alarm activated and waits to exceed the setpoint once to act as in LO mode
- **PROGRAMMABLE TIME DELAY or HYSTERESIS:** Each output action can be deferred by a programmable time delay or hysteresis level.

The time delay is the time that takes the output to activate after passing through the setpoint in the up or down direction, while the hysteresis band will be selected asymmetrical i.e. only acts on the output deactivation edge. The delay is programmable in seconds, from 0 to 99. The hysteresis can be programmed, in counts, within the full display range. The decimal point appears in the same position as programmed in the display configuration module.

The figures 1 and 2 show the time delay action (dly) and the asymmetrical hysteresis action (hys-1) of two alarms (SET1 and SET2) programmed to activate in HI mode (OUT1) and LO mode (OUT2)

- **TRACK MODE:** Preliminary floating preset in Set2 and Set4 that act on Set1 and Set3 activating relay 2 and relay 4 a fixed number of accounts before the values selected in Set1 and Set3. If Set1 or Set3 is modified it is not necessary to modify Set2 and Set4 that will remain in the same distance with respect to Set1 and Set3.

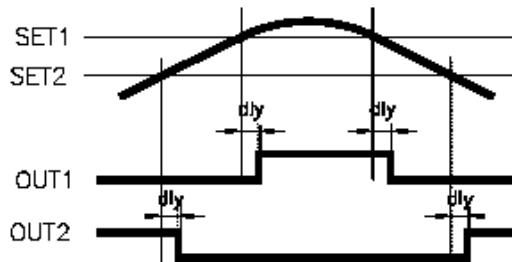

Delay action

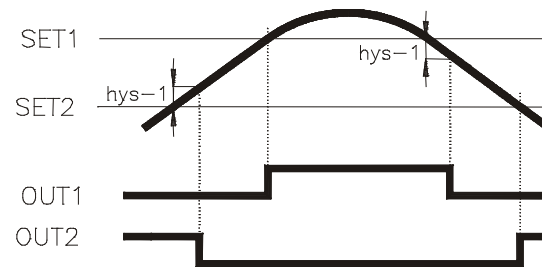

Asymmetrical hysteresis

## 9.1.7 - Diagram of the SETPOINTS menu in COUNTER / CHRONOMETER mode

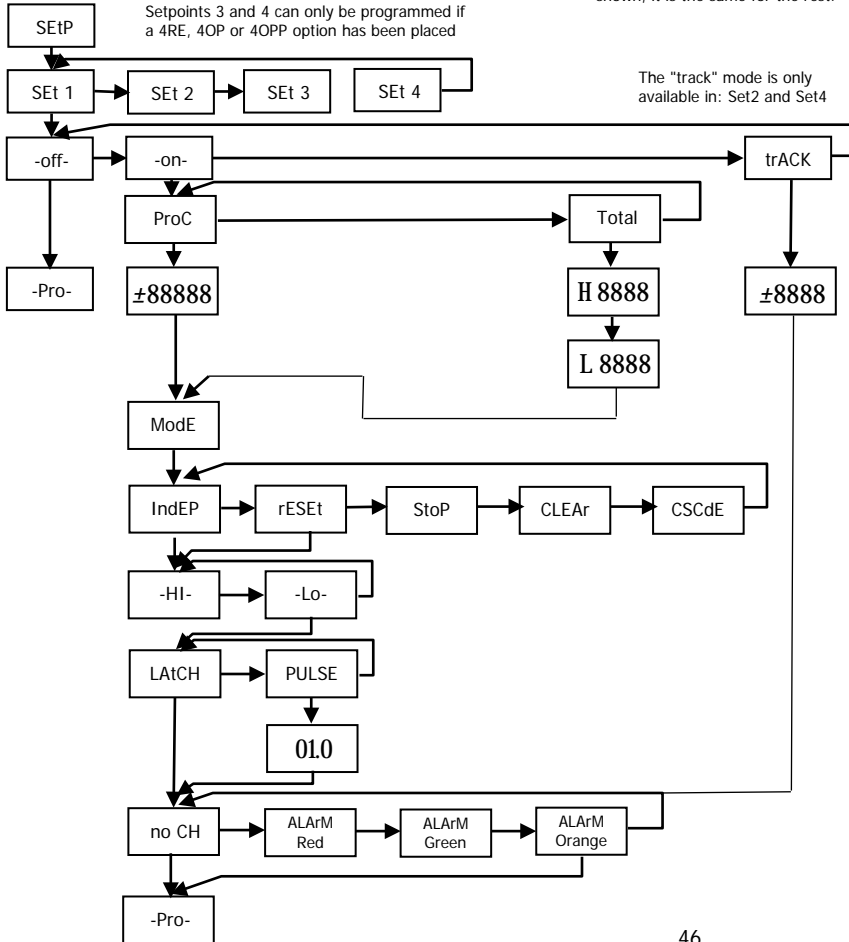

The complete programming of only one of the Setpoints is shown, it is the same for the rest.

## 9.1.8 - Description Relay Operation Mode as Counter / Stopwatch

**Mode 1 - IndEP:** When the process or total counter arrives, (depending on the programming) at the set point value, the output is activated according to whether it is a pulse or a latch, whether it is lower or higher than the programmed value.

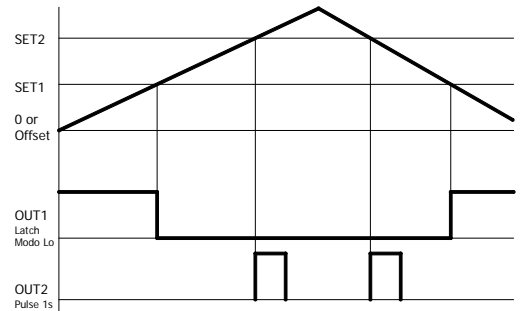
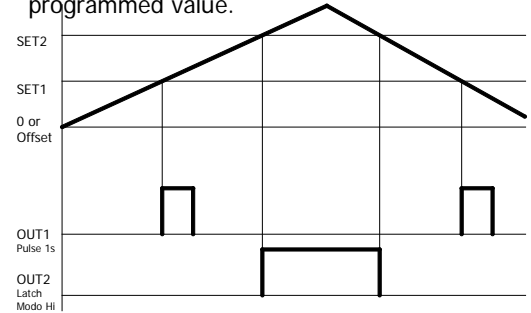

**Mode 2 - Reset:** The value of the variable to which the setpoint refers is set to zero (or the offset value) when the output is activated. In this mode, the output can not be programmed as a Latch

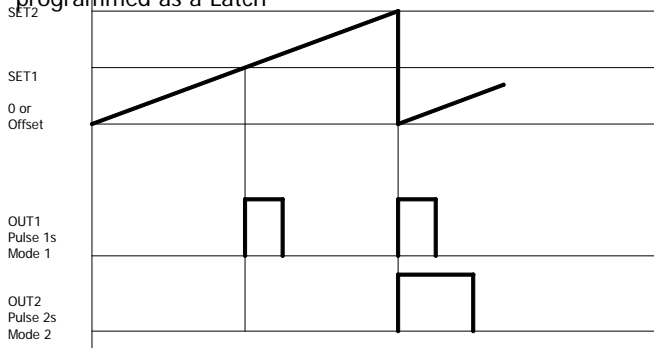

**Mode 3 - Stop:** The process counter or total (the one referred to the set point) if it is active is stopped when it reaches the setpoint. Counters are restarted when the counter to which the setpoint is referred is reset.

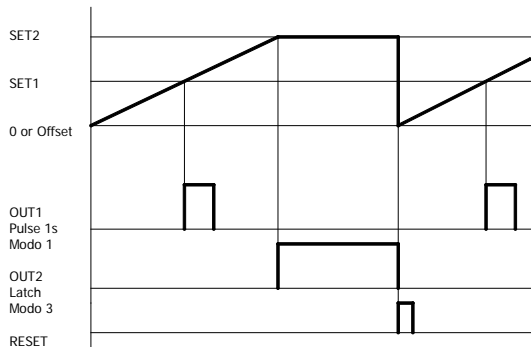

**Mode 4 - Clear:** The output is activated in latch or pulse mode when the setpoint is reached. The previous output is disabled in the order Set1, Set2, Set3, Set4.

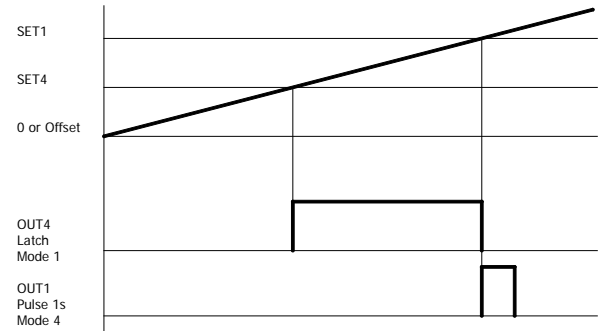

**Mode 5 - Cascade:** When the counter reaches the preset, the output is activated and the display is reset, then the operation is repeated with the following set points.

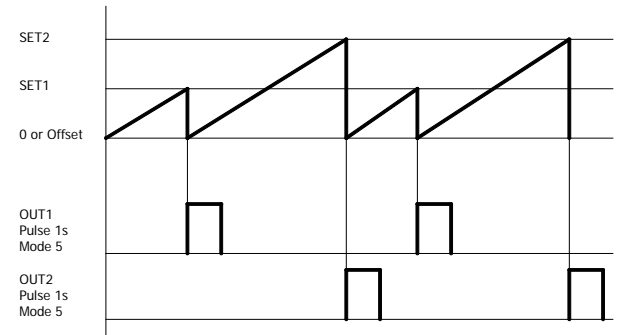

## 9.2 – RS2 / RS4 / ETH Output

### 9.2.1 – Introduction

The RS232C output option consists of an additional card (reference **RS2**) that is installed in the M2 plug-in connector of the instrument's main board. The card incorporates one 4 wires telephone socket with output at the rear of the instrument.

The RS485 output option consists of an additional card (reference **RS4**) that is also installed in the M2 plug-in connector of the instrument's main board. The card incorporates a 6-pin / 4-contact telephone socket with output at the rear of the instrument.

The serial output permits to construct a communication line through which a master device can request the transmission of data such as display value, setpoint values, peak, valley, tare (or offset in case of thermometers) and to perform operations such as tare of the display, reset of the peak, valley or tare memories and update setpoint values..

The output option is totally software configurable as for the transmission rate (1200, 2400, 4800, 9600 or 19200 Baud), the instrument's address (from 00 to 99), the protocol (ASCII, ISO 1745 and MODBUS RTU).

The operating mode is half-duplex and it normally stands in data reception mode until reception of a message.

A valid data transmission may cause the immediate execution of an action (tare, reset of peak, valley or tare memories modification of setpoint values) or the transmission of a response from the instrument (display value, one of the setpoints value, peak, valley, tare / offset). Only the display value can be called up via external contact according diagram in page 9 of RS2 manual.

Three communication modes are available; the ASCII mode uses a simple protocol compatible with several DITEL instruments. The ISO mode, in accordance with the ISO 1745 norm, allows a more effective communication in noisy environments as it checks the messages validity checking both transmission and reception. And eventually the protocol MODBUS RTU

As you will see in the functions table, the protocol ASCII uses 1 or 2 bytes according to the command type and the protocol ISO 1745 imposes the use of two bytes per command.

For the Ethernet output, consult the specific manual that accompanies the **ETH** output



## 9.2. 2 – Diagram of the menu Input RS

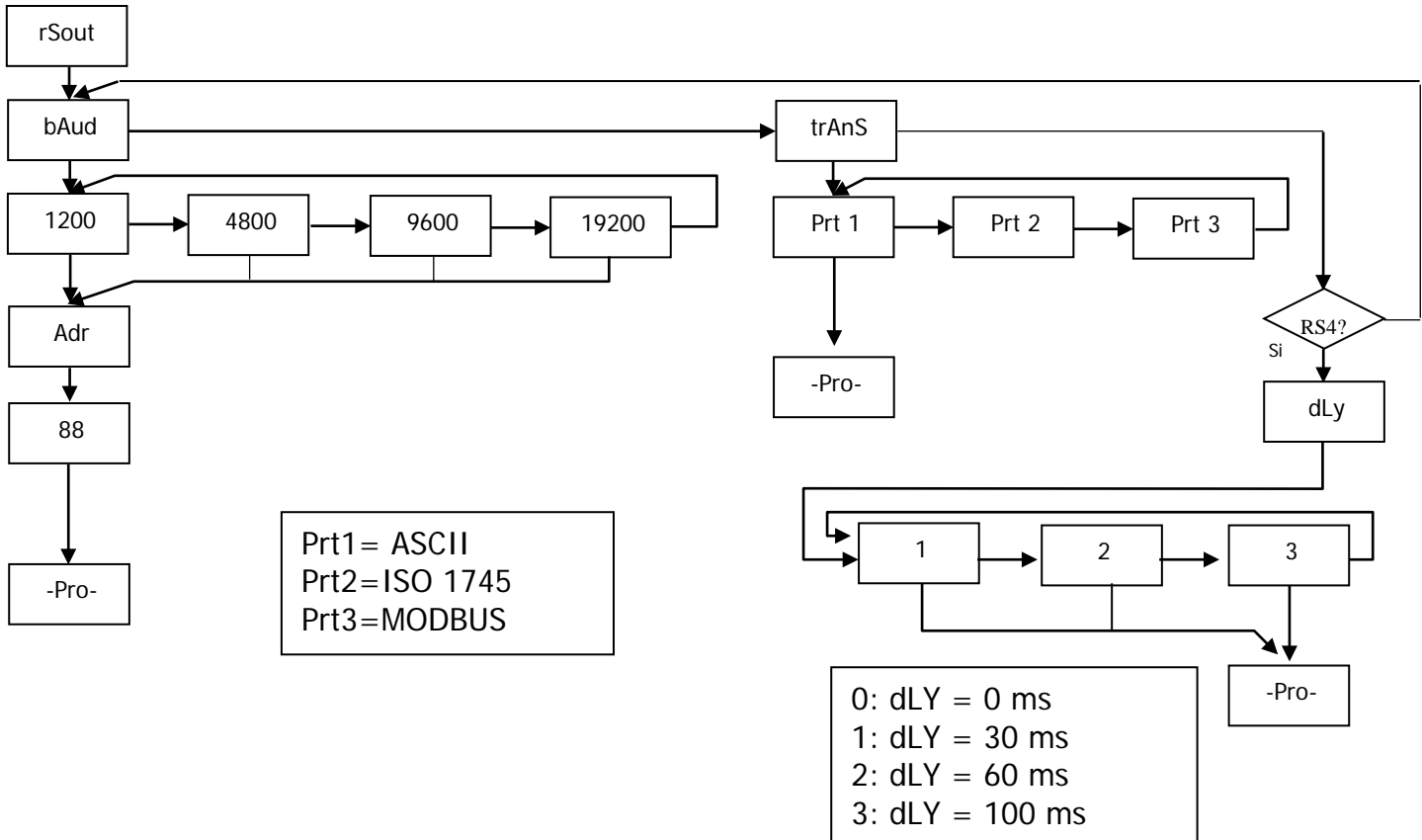

## ASCII PROTOCOL

The Transmission format is: 1 START bit, 8 DATA bits, NO parity bit and 1 STOP bit.

- MESSAGE FORMAT TO BE SENT

A message sent to the instrument must be composed of the following sequence of ASCII characters:

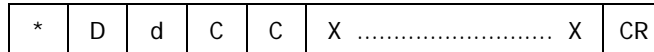

One " \* " byte [ASCII 42] of start of message.

Two address bytes (from 00 to 99).

One or two ASCII characters corresponding to the desired command according to the functions table (List of commands).

In case that the command request for a modification of parameters, the new value shall be transmitted with one byte of sign (+ [ASCII 43] or - [ASCII 45] ) followed by a block of N ASCII characters (depending on model), including the decimal point.

One " CR " [ASCII 13] character of end of message. CR= Carriage Return

- MESSAGE FORMAT FROM INSTRUMENT

The data sent from the instrument as a response to a data request type command from the master device is the following:

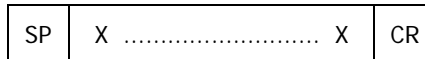

One byte of blank space [ASCII 32].

One text (requested values) consisting of a byte of sign (+ [ASCII 43] or - [ASCII 45] ) followed by a block of N ASCII characters (depending on model) including the decimal point.

One " CR " byte [ASCII 13] of end of message. CR = Carriage Return

If the command belongs to "orders" or "changing parameters", the instruments gives no response.

## ISO 1745 PROTOCOL

The transmission format is: 1 START bit, 7 DATA bits, 1 EVEN PARITY bit and 1 STOP bit.

### • MESSAGE FORMAT TO BE SENT

The message format, as sent from the master device, must consist of the following sequence of characters:

SOH	D	d	STX	C	C	X ..... X	ETX	BCC
-----	---	---	-----	---	---	-----------	-----	-----

One byte SOH of start of message [ASCII 01].

Two bytes corresponding the first to the tens and the second to the units of the instrument address number.

One byte STX of start of text [ASCII 02].

Two commands bytes according to the functions table.

In case of commands that change parameters, a block of N bytes corresponding to the new value including sign and decimal point.

One byte ETX of end of text [ASCII 03].

One control byte BCC calculated in the following manner:

Perform an exclusive-OR with all bytes between the STX (not included) and the ETX (included).

- If the obtained byte (in ASCII format) is higher than 32, it can be taken as the BCC.
- If the obtained byte (in ASCII format) is lower than 32, the BCC byte will be obtained by adding 32.

### • MESSAGE FORMAT FROM INSTRUMENT

The format of a message as sent from the instrument in response to a command from the master device is the following:

#### 2. In case of commands that ask for transmission of a value (data request type):

SOH	D	d	STX	X .....	X	ETX	BCC
-----	---	---	-----	---------	---	-----	-----

One byte SOH of start of message [ASCII 01].

Two address bytes.

One byte STX of start of text [ASCII 02].

N bytes corresponding to the requested value (including the sign and decimal point).

One byte ETX of end of text [ASCII 03].

One control byte BCC calculated with the method described in above.

#### 2. In case of commands that do not imply the return of a value (command type or changing parameter):

D	d	ACK	or	D	d	NAK
---	---	-----	----	---	---	-----

The instrument sends a confirmation when it receives a message.

If the message has been correctly received and interpreted, the response will consist of two address bytes and one "ACK" [ASCII 06]

If the received message has not been well interpreted or it has been detected as to have errors, the response will be two address bytes and a "NAK" [ASCII 21].

## List of commands

### DATA REQUEST

ASCII	ISO	Information
P	0P	Peak value
V	0V	Valley value
T	0T	Tare or offset value
D	0D	Display value
Z	0Z	Display Totalizer
I	0I	Byte relays status
L1	L1	Setpoint 1 value
L2	L2	Setpoint 2 value
L3	L3	Setpoint 3 value
L4	L4	Setpoint 4 value
NB		Cards installed
		Returns:
		- "08": RS2
		- "09": RS2, 2RE
		- "0": RS2, 4OP
		- "10": RS4
		- "11": RS4, 2RE
		- "12": RS4, 4 Setpoints(4RE, 4OP or 4OPP)
		- "0<": NMA or NMV, RS2
		- "0=": NMA or NMV, RS2, 2RE
		- "0>": NMA or NMV, RS2, 4 Setpoints(4RE, 4OP or 4OPP)
		- "14": NMA or NMV, RS4
		- "15": NMA or NMV, RS4, 2RE
		- "16": NMA or NMV, RS4, 4 Setpoints(4RE, 4OP or 4OPP)
TT		Model + Version
SC		Send configuration
RC		Receive configuration

### MODIFICATION OF DATA

ASCII	ISO	Parameter
M1	M1	Change setpoint 1 without saving
M2	M2	Change setpoint 2 without saving
M3	M3	Change setpoint 3 without saving
M4	M4	Change setpoint 4 without saving

### COMMANDS

ASCII	ISO	Command
p	0p	Peak reset
v	0v	Valley reset
r	0r	Tare/offset reset without saving
t	0t	Tare/offset without saving
z	0z	Reset Totalizer
d	0d	Reset process value
rl	rl	Return to factory settings
b1	b1	Low brightness display (without saving)
b2	b2	High brightness display (without saving)
c1	c1	Display orange (without saving)
c2	c2	Display green (without saving)
c3	c3	Display red (without saving)
hs	hs	Start chronometer
ht	ht	Stop chronometer

## 9.3 ANALOG OUTPUT

### 9.3.1 – Introduction

Two ranges of analog output (0-10 V and 4-20 mA) can be incorporated to the FD6200 by means of an additional card, either the NMV card for voltage output or the NMA card for current output, which is installed on the meter's main board via plug-in connector M3, both cards, cannot be used simultaneously.

The outputs are opto-isolated with respect to the signal input and the power supply.

The optional board provides a two terminal connector [(+) and (-)] that drives out a signal variation from 0 to 10V or from 4mA to 20mA proportional to a user-defined display range.

This way, the meter is furnished with a signal that can be used to control variables and operates at each moment proportionally to the magnitude of the effect under control.

These signals can also be used to transmit display information to a variety of terminal equipment such as graphic recorders, controllers, remote displays or other devices that accept input data in analog form.

The instrument will detect the type of option that has been installed and will operate in accordance.

The display values producing the full scale output (OUT-HI and OUT-LO) are also introduced via front-panel buttons in the same programming module. The analog output then follows the display variation between the HI and LO programmed points.

The output signal can be set up for reverse action by programming the low display for the high output (OUT-HI) and the high display for the low output (OUT-LO).

### 9.3.2 – Installation of NMA or NMV option

Lift out the electronics assembly from the case and use a screwdriver to pull on the junctions between the case and the grey-marked area to detach it from the case. The so performed orifice will allow the analog output board connector be brought out at the rear of the instrument. Install the circuit board so that the lower pin fits into the corresponding main board insertion slot and push down to plug the M3 option connector in the main board M3 location. If the instrument is to be installed in high vibrating environments, it is recommended to solder the card to the main board making use of the copper tracks on both sides of the card pin and around the main board hole on its solder side.

### 9.3.3 – Connection

Each output card is supplied with an adhesive label that indicates the wiring connections of each option (see fig.). To help identifying each terminal, this label should be placed in the side of the meter case, beside the basic functions label.

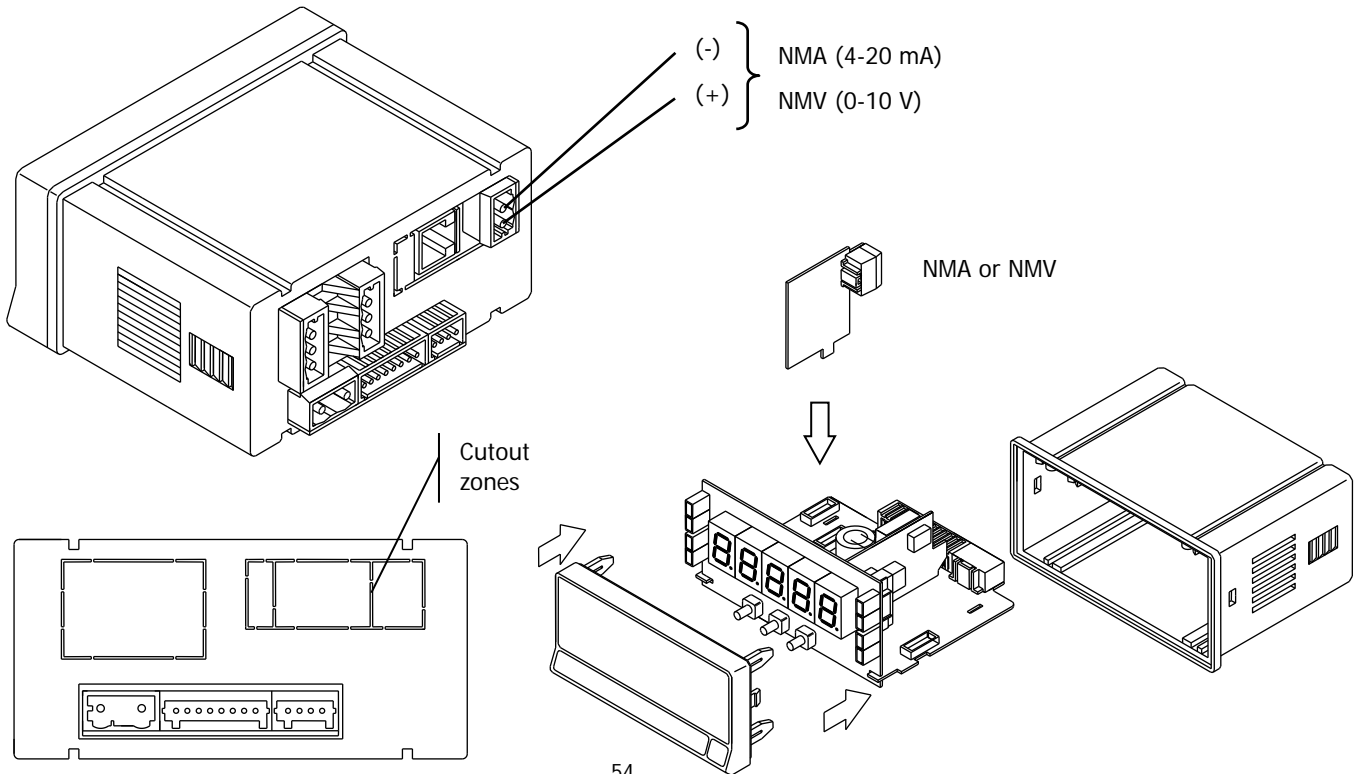

### 9.3.4 – Technical specifications

#### CHARACTERISTICS

	NMA OUTPUT	NMV OUTPUT
RESOLUTION.....	13 BITS.....	13 BITS.....
ACCURACY.....	0.1% F.S. ±1BIT.....	0.1% F.S. ±1BIT.....
RESPONSE TIME.....	50 ms.....	50 ms.....
THERMAL DRIFT.....	0.5 µA/°C.....	0.2 mV/°C.....
MAXIMUM LOAD.....	<= 500 Ω.....	>=10 KΩ.....

### 9.3.5 – Analog output menu diagram

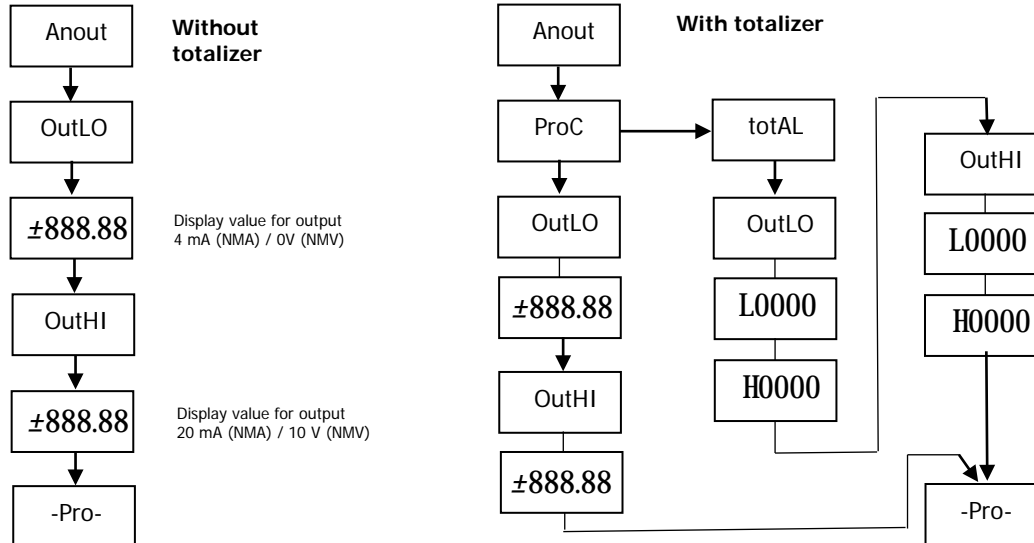

## 10. Technical Characteristics

### INPUT SIGNAL

#### Frequency meter and Tachometer input

##### Maximum and minimum frequency

Frequency (min) (Freq / Tach) .....	0.01 Hz
Frequency (max) (Freq / Tach) .....	20 KHz
Frequency (max) (Totalizer Tach).....	8 KHz
Frequency (max) (Tach mode Duty) .....	1 kHz

##### Counter input

All configurations

Without Totalizer .....	11 KHz
With Totalizer .....	9 KHz

<b>EXCITATION</b> .....	8V DC @ 30mA
	20Vdc (not stabilized) @ 100 mA

##### Contact closure input

###### FILTER

Fc duty cycle 50% .....	20Hz
Fc duty cycle 30% .....	10Hz

### INPUTS (2 CHANNELS)

#### MAGNETIC PICKUP

Sensitivity .....	Vin (AC) > 60mVpp @ F < 1kHz
	>100 mVpp @ F >1 kHz

#### NAMUR

Rc .....	3k3 (incorporated)
Ion .....	< 1mA DC
Ioff .....	> 3mA DC

#### TTL/24V DC (encoder)

Logic levels .....	"0" < 2.4V DC, "1" > 2.6V DC
--------------------	------------------------------

#### NPN or PNP

Rc .....	3K3 (incorporated)
Logic levels .....	"0" < 2.4V DC, "1" > 2.6V DC

#### CONTACT CLOSURE

Vc .....	5V
Rc .....	3.9K
Fc (activated automatically) .....	20Hz

#### HIGH VOLTAGE INPUT (1 CHANNEL)

Voltage limits .....	10 to 300V AC
----------------------	---------------



## COUNTER Y CHRONOMETER MEMORY

Non-volatile E2PROM retains all programming data and count value when power is removed or interrupted.

## DISPLAY

Type ..... 5 programmable tricolor 14 mm digits  
LED's ..... 8, control and status indication  
Decimal Point ..... programmable  
Sign ..... automatic s/configuration  
Positive overflow indication ..... OvEr  
Negative overflow indication ..... -OvEr

Counter display limits ..... Process -99999 to 99999

Totalizer ..... -99999999 to 99999999  
Chronometer ranges ..... 4, from 999.99s to 99999h  
Frequency ranges ... 0.01 Hz to 20KHz/10KHz(totalizer)  
Tachometer range ... 0 to 99999(rpm), programmable (rate)  
Scale factor  
Counter ..... programmable from 0.00001 to 99999  
Freq/Tach ..... programmable from 0.0001 to 99999

Display update rate

Counter ..... 100ms  
Chronometer ..... 100ms  
Frequency/Tachometer ..... programmable 0.1 to 9.9s

## POWER

FD6200 ..... 85 to 265 Vac 50/ 60Hz  
..... 100 to 300 V dc  
FD6260 ..... 10,5-70V DC  
..... 22 to 50 V ac 50/ 60 Hz

Consumption ..... 5W (without options), 10W max

## ACCURACY

Frequency/Tachometer ..... 0,005%  
Chronometer ..... 0, 01%  
Temperature coefficient ..... 50 ppm/°C  
Warm up time ..... 5 minutes

## ENVIRONMENTAL

Indoor use  
Operating temp. .... -10°C to 60°C  
Storage temperature ..... -25°C to +85°C  
Relative humidity (non condensing) ..... < 95% at 40°C  
Max altitude ..... 2000m

## MECHANICAL

Dimensions ..... 96x48x60mm (DIN 43700)  
Panel cutout ..... 92x45mm  
Weight ..... 200g  
Case material ..... Polycarbonate (UL 94 V-0)  
Sealed front panel ..... IP65

## CONFORMITY CE



To obtain the declaration of conformity corresponding to this model enter our website [www.fujielectric.fr](http://www.fujielectric.fr) , where said document, the technical manual and other information of interest can be downloaded freely.



Caution: Read the instructions manual to preserve safety protections



The instruments are warranted against defective materials and workmanship for a period of five years from date of delivery.

If a product appears to have a defect or fails during the normal use within the warranty period, please contact the distributor from which you purchased the product.

This warranty does not apply to defects resulting from action of the buyer such as mishandling or improper interfacing.

The liability under this warranty shall extend only to the repair of the instrument. No responsibility is assumed by the manufacturer for any damage which may result from its use.



## INSTRUCTIONS FOR THE RECYCLING

This electronic instrument is covered by the **2012/19/UE** European Directive so, it is properly marked with the crossed-out wheeled bin symbol that makes reference to the selective collection for electrical and electronic equipment which indicates that at the end of its lifetime, the final user cannot dispose of it as unsorted municipal waste.

In order to protect the environment and in agreement with the European legislation regarding waste of electrical and electronic equipments from products put on the market after 13 August 2005, the user can give it back, without any cost, to the place where it was acquired to proceed to its controlled treatment and recycling.

### **Fuji Electric France S.A.S.**

46 Rue Georges Besse - ZI du Brézet  
63039 Clermont-Ferrand CEDEX02 - FRANCE

Tel: +33 - 4 73 98 26 98

Fax: +33 - 4 73 98 26 99

E-mail: [sales.dpt@fujielectric.fr](mailto:sales.dpt@fujielectric.fr)

[www.fujielectric.fr](http://www.fujielectric.fr)