



Instruction Manual

ZIRCONIA OXYGEN ANALYZER CONVERTER

Type: ZKMA, ZKMB



PREFACE

We are grateful for your purchase of Fuji Direct Insertion Type Zirconia Oxygen Analyzer Converter (ZKM).

- First read this instruction manual carefully until an adequate understanding is acquired, and then proceed to installation, operation and maintenance of the converter. Improper handling may result in accidents or injury.
- The specifications of this converter will be changed without prior notice for further product improvement.
- Modification of this converter is strictly prohibited unless a written approval is obtained from the manufacturer. Fuji will not bear any responsibility for a trouble caused by such a modification.
- This instruction manual shall be stored by the person who actually uses the converter.
- After reading through the manual, be sure to keep it near at hand for future reference.
- This product falls within category 9 (Monitoring and control instruments including industrial monitoring and control instruments) of Annex 1 of EU RoHS directive (2011/65/EU). Please do not use it for consumer use.
- This instruction manual should be delivered to the end user without fail.

Manufacturer: Fuji Electric Co., Ltd.
Type: Described in the nameplate put on the main body
Date of manufacture: Described in the nameplate put on the main body
Product nationality: Japan

- Related instruction manual
Direct insertion type zirconia oxygen analyzer detector (Type: ZFK8)INZ-TN5ZFK8-E

Notice

- It is prohibited to transfer part or all of this manual without Fuji Electric's permission in written format.
- Description in this manual is subject to change without prior notice.



Fuji Electric Co., Ltd. 2015

Issued in October 2015
Rev. 1st edition February, 2017
Rev. 2nd edition May, 2018

SAFETY PRECAUTIONS



First of all, read this “SAFETY PRECAUTIONS” carefully, and then use in the correct way.

- Installation, transportation, wiring, use, maintenance of this product shall be carried out by suitably trained personnel.
- First-time users should operate the instrument under the supervision of a fully competent person in the operation.
- Be sure to observe the instructions shown below, because they describe important information on safety. Those safety precautions are ranked in 3 levels, “DANGER”, “CAUTION” and “PROHIBITION”.

 DANGER	If operation is incorrect, a dangerous situation may occur, resulting in death or serious injuries.
 CAUTION	If handled wrongly, a dangerous situation may occur, and medium trouble or slight injury may be caused and only property damage may be caused.
 PROHIBITION	Items which must not be done are noted.



- The items noted under “ CAUTION” may also result in serious trouble depending on circumstances. All the items are important and must be fully observed.

Caution on installation and transportation

 DANGER	<ul style="list-style-type: none"> • This unit is not explosion-proof type. Do not use it in an atmosphere of explosive gases. Otherwise serious accidents such as explosion or fire may result.
 CAUTION	<ul style="list-style-type: none"> • This unit should be installed in a place which conforms to the conditions noted in the instruction manual. Otherwise, it may cause electric shocks, fire, failure or malfunction of the unit. • During installation work, care should be taken to keep the unit free from entry of cable chips or other foreign objects. Otherwise, it may cause fire, failure or malfunction of the unit. • For installation, observe the rule on it given in the instruction manual and select a place where the weight of converter can be endured. Installation at an unsuited place may cause turnover or fall and there is a risk of injury. • Be sure to wear gloves when handling the unit. Bare hands may invite an injury. • Before transport, fix the door so that it will not open. Otherwise, the door may be separated and fall to cause an injury.

Cautions on wiring

 CAUTION	<ul style="list-style-type: none"> • Be sure to turn off all the power before performing wiring. Otherwise electric shock may result. • Be sure to perform class D grounding work. Otherwise, electric shock or failure may result. • Select a proper wiring material that satisfies the ratings of the instrument. Otherwise, electric shock or fire may result. • Connect power source of correct rating. Connection of a power source of incorrect rating may lead to a risk of fire.
--	--

Cautions on use	
 DANGER	<ul style="list-style-type: none"> • If unusual smell or sound has been produced, immediately stop the instrument. Any discharge produced may cause a fire.
 CAUTION	<ul style="list-style-type: none"> • Leaving the converter unused for a long time or restarting it after disuse requires procedures different from normal operation or suspension procedures. Be sure to follow the instructions in each instruction manual. Otherwise, intended performance may not be achieved, or accidents or injury may result. • Do not operate the converter for a long time with its door left open. Otherwise, dust, foreign matter, etc. may stick on internal walls, thereby causing failure.
 PROHIBITION	<ul style="list-style-type: none"> • Do not touch the input/output terminals with metal or finger. Otherwise, failure, electric shock or injury may result.

Caution on maintenance and inspection	
 CAUTION	<ul style="list-style-type: none"> • Before maintenance and check, be sure to turn off the main power supply and wait until the detector is cooled adequately. Otherwise, you may suffer a burn. • Before removing the detector from the flue for maintenance and check, make sure the furnace is stopped. Otherwise, you may suffer a burn. • Before working, take off a wrist watch, finger ring or the like metallic accessories. And never touch the instrument with a wet hand. Otherwise, you will have electric shocks. • If the fuse is blown, eliminate the cause, and then replace it with the one of the same capacity and type as before. Otherwise, it may cause electric shocks or failure.

Others	
 CAUTION	<ul style="list-style-type: none"> • If the cause of a failure cannot be identified by referring to the instruction manual, be sure to contact your dealer or Fuji's technician in charge of adjustment. Disassembling the instrument carelessly may result in electric shock or injury. • Do not use a replacement part other than specified by the instrument maker. Otherwise, adequate performance will not be provided. Besides, an accident or failure may be caused. • Replacement parts such as a maintenance part should be disposed of as incombustibles.

Electrical Safety:

- Overvoltage category
 - ; II power supply input
 - ; I relay interfaces
 (IEC1010-1)
- External overcurrent protective device
 - ; 10A
- Equipment interfaces are safety separated (SELV)

WARRANTY AND MAINTENANCE

1. Scope of application

To use this equipment, the following conditions must be met:

- the use of the equipment incurs no risk of a serious accident even if a failure or malfunction occurs on the equipment, and
- in case of product failure or malfunction, safety measures such as redundant design, prevention of malfunction, fail safe system, foolproof mechanism are provided outside of the equipment.

Be sure to use this instrument under the conditions or environment mentioned in this instruction manual.

Please consult us for specifications for the following applications:

Harsh conditions for electronics, or other usages that may have large impact on lives, bodies, property, or other rights or interests.
--

2. Operating conditions and environment

Refer to “Caution on Safety”.

3. Precautions and prohibitions

Refer to “Caution on Safety”.

4. Warranty

4-1. Period of warranty

- 1) Warranty period for this product including accessories is one year after delivery.
- 2) Warranty period for the parts repaired by our service providers is six months after the completion of repair.

4-2. Scope of warranty

- 1) If any failure or malfunction attributable to Fuji Electric occurs in the period of warranty, we shall provide the product after repairing or replacing the faulty part for free of charge at the place of purchase or delivery.

The warranty does not apply to failure or malfunctions resulting from:

- a) inappropriate conditions, environment, handling or usage that is not instructed in a catalog, instruction book or user's manual, or overuse of the product
- b) other devices not manufactured by Fuji Electric
- c) improper use, or an alteration or repair that is not performed by Fuji Electric
- d) inappropriate maintenance or replacement of expendable parts listed in the instruction book or the catalog
- e) damages incurred during transportation or fall after purchase
- f) any reason that Fuji Electric is not responsible for, including a disaster or natural disaster such as earthquake, thunder, storm and flood damage, or inevitable accident such as abnormal voltage.

2) Regardless of the time period of the occurrence, Fuji Electric is not liable for the damage caused by the factors Fuji Electric is not responsible for, opportunity loss of the purchaser caused by malfunction of Fuji Electric product, passive damages, damage caused due to special situations regardless of whether it was foreseeable or not, and secondary damage, accident compensation, damage to products that were not manufactured by Fuji Electric, and compensation towards other operations.

5. Failure diagnosis

Regardless of the time period of the occurrence, if any failure occurs, the purchaser shall perform a primary failure diagnosis. However, at the purchaser's request, Fuji Electric shall provide the diagnosis service for a fee. In such a case, the purchaser shall be charged for the service.

6. Service life

This product, excluding limited-life parts and consumable parts, is designed for a service life of 10 years under a general condition (average ambient temperature of 30°C).

The service life may be shortened depending on operating conditions and environment. To ensure the service life, it is important to perform planned maintenance of the product including limited-life parts and consumable parts.

7. Maintenance plan

Maintenance can be divided into “preventive maintenance” and “corrective maintenance”. Preventive maintenance can further classified into “daily inspection” and “periodic inspection”. Preventive maintenance is achieved through systematic implementation of "daily inspection" and "periodic inspection".

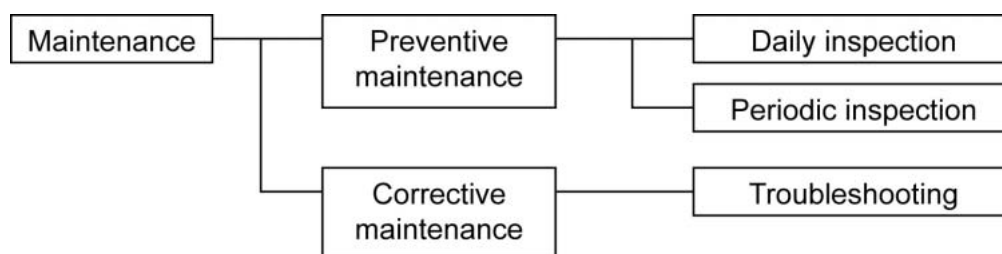

(1) Daily inspection

Be sure to perform daily inspection prior to operation to check for any problem in daily operation. For the specific items of daily inspection, refer to Chapter 9, “MAINTENANCE AND CHECK”.

(2) Periodic inspection

Periodic inspection is to replace limited-life parts before their service lives are over, thus preventing failure. Inspection interval: 6 months to 12 months. If you are using the instrument under harsh environment, we recommend you to shorten the inspection interval. For the specific items of periodic inspection, refer to Chapter 9, “MAINTENANCE AND CHECK”.

(3) Corrective maintenance

Corrective maintenance is a measure to be taken after a trouble has occurred. Refer to 9.5 “Troubleshooting”. If the measures mentioned in this instruction manual do not solve the problem, please contact our sales office or service office.

8. Limited-life parts and consumable parts

This product contains the following limited-life parts and consumable parts which may affect the service life of the product itself.

(1) LCD

- Design life: approx. five years for continuous use
- Symptoms of LCD screen's end-of-life: deterioration of display, backlight failure, etc.
- Factors which affect LCD's life: temperature. The life is shortened by half when the temperature rises by 10°C. (Arrhenius' law)
- Replacement: Estimate the lifetime of LCD according to your operating environment, and have the LCD replaced at appropriate time.

(2) Aluminum electrolytic capacitors

- Design life: 5 years under general working conditions (annual average of ambient temperature: 30°C)
- Symptoms when a capacitor loses its capacity: deterioration of power quality, malfunction
- Factors which affect capacitor life: temperature. The life is shortened by half when the temperature rises by 10°C. (Arrhenius' law)
- Replacement: Estimate the lifetime of capacitor according to your operating environment, and have the capacitor replaced or overhauled at appropriate time, at least once in 10 years.

Do not use capacitors beyond its lifetime. Otherwise, electrolyte leakage or depletion may cause odor, smoke, or fire. Please contact Fuji Electric or its service providers when an overhaul is required.

9. Spare parts and accessories

Refer to “Checking of contents of the package” or Chapter 9, “MAINTENANCE AND CHECK” for details.

10. Period for repair and provision of spare parts after product discontinuation (maintenance period)

The discontinued models (products) can be repaired for five years from the date of discontinuation. Also, most spare parts used for repair are provided for five years from the date of discontinuation. However, some electric parts may not be obtained due to their short life cycle. In this case, repair or provision of spare parts may be difficult even in the above period.

Please contact Fuji Electric or its service providers for further information.

Contents

PREFACE	i
SAFETY PRECAUTIONS	ii
WARRANTY AND MAINTENANCE	iv
CHECKING OF CONTENTS OF THE PACKAGE	x
STORAGE CONDITIONS	x
1. GENERAL	1
1.1 Direct insertion type zirconia oxygen analyzer	1
2. OPERATING PARTS AND THEIR FUNCTIONS	2
2.1 Outline Drawing	2
2.2 Terminal block	3
2.3 Display and operation panel	3
2.4 Internal constitution	4
3. INSTALLATION	5
3.1 Installation site	5
3.2 How to install the converter	6
3.2.1 Mounting on panel (ZKMA)	6
3.2.2 Pipe mounting (ZKMA)	6
3.2.3 Mounting on panel (ZKMB)	7
3.2.4 Pipe mounting (ZKMB)	7
4. WIRING AND PIPING	8
4.1 Before wiring	9
4.2 Wiring to terminals	10
4.2.1 Wiring to power supply and detector	10
4.2.2 Cable gland and input and output lines	11
4.2.3 Allocation of the terminal block	12
4.3 Wiring and piping diagram	13
4.4 Handling of standard gas (An article on separate order)	17
5. OPERATION	18
5.1 Preparation for operation	18
5.2 Key operation flow diagram (outline)	20
5.3 Initial parameter value table	24
5.3.1 Parameters related to measurement	24
5.3.2 Parameters related to calibration	24
5.3.3 Parameters related to blowdown (displayed if the option is provided)	25
5.3.4 Parameters related to maintenance	25
5.3.5 Other parameters	26
6. OPERATION START AND STOP	28
6.1 Operation start	28
6.2 Operation stop	28
6.3 Actions during operation	29
6.4 Check the contents of display	30
6.4.1 Check of state information	30
6.4.2 Checking the error information	31
6.4.3 Checking the alarm information	31
6.5 Oxygen detector standard output voltage	32

7. CALIBRATION	33
7.1 Preparation	33
7.2 Manual calibration	34
7.3 Auto calibration (option).....	36
7.4 Remote calibration	38
7.5 All calibration (option).....	40
8. BLOWDOWN (OPTION)	41
8.1 Preparation for blowdown.....	41
8.2 Manual blowdown.....	41
8.3 Automatic blowdown	42
8.4 Remote blowdown	44
9. MAINTENANCE AND CHECK	46
9.1 Checking	46
9.2 Spare parts.....	46
9.3 Replacement of fuse.....	47
9.4 Adjustment of monitor contrast.....	48
9.5 Troubleshooting	49
10. SETTING AND OPERATING OF PARAMETER	51
10.1 Measured menu.....	51
10.1.1 Display range setting screen.....	51
10.1.2 Decimal point position setting screen.....	52
10.1.3 Full scale setting screen.....	53
10.1.4 Setting screen for calculation time of maximum and minimum values appears	54
10.2 Calibration menu.....	55
10.2.1 Automatic calibration setting (option).....	55
10.2.2 Date and time for starting automatic calibration (option)	56
10.2.3 Cycle time setting of automatic calibration (option).....	57
10.2.4 Performing all calibration (option).....	58
10.2.5 Performing a manual span calibration.....	59
10.2.6 Performing a manual zero calibration	60
10.2.7 Calibration gas setting	61
10.2.8 Calibration waiting setting (option).....	62
10.2.9 Calibration error clear	63
10.2.10 Operation setting screen of calibration range	64
10.3 Blowdown menu (option)	65
10.3.1 Automatic blowdown setting.....	65
10.3.2 Date and time setting of automatic blowdown	66
10.3.3 Automatic blowdown cycle setting	67
10.3.4 Procedure for setting blowdown time.....	68
10.3.5 Performing manual blowdown.....	69
10.4 Maintenance menu	70
10.4.1 Error log display	70
10.4.2 Clearing error logs.....	72
10.4.3 Alarm log display	73
10.4.4 Clearing alarm logs	74
10.4.5 Performing a manual sensor check.....	75
10.4.6 Maintenance mode setting.....	76
10.4.7 Password setting.....	77
10.4.8 PID auto tuning	78
10.5 Parameter menu	79
10.5.1 Current date and time setting.....	79
10.5.2 Contact input setting.....	80
10.5.3 Selection of alarm contact output.....	81
10.5.4 High limit setting of oxygen concentration	82

10.5.5 Lower limit setting of oxygen concentration	83
10.5.6 HH limit setting of oxygen concentration	84
10.5.7 LL limit setting of oxygen concentration	85
10.5.8 Hysteresis Setting	86
10.5.9 Hold treatment setting (maintenance hold)	88
10.5.10 Hold value setting (maintenance hold)	89
10.5.11 Setting of hold setting value (maintenance hold)	90
10.5.12 Setting of measurement recovery time (maintenance hold)	91
10.5.13 Hold treatment setting (error hold)	92
10.5.14 Hold value setting (error hold)	93
10.5.15 Setting of hold setting value (error hold)	94
10.5.16 Setting of key lock	95
10.5.17 Setting of automatic OFF time	96
10.5.18 Station number setting	97
10.5.19 Adjustment screen for analog output 0%	98
10.5.20 Adjustment screen for analog output 100%	99
10.5.21 Fuel coefficient setting (option)	100
10.6 Factory menu	101
10.6.1 Password setting screen	101
11. SPECIFICATIONS	102
11.1 Specifications	102
11.2 Code symbols	104

CHECKING OF CONTENTS OF THE PACKAGE

- Check that all of the following are contained in the delivered package.

- (1) Zirconia Oxygen Analyzer Converter main unit 1 unit
- (2) Accessories 1 set (Refer to the table below.)

Table 1 Standard accessories

No.	Item	Q'ty	Remarks
1	Fuse	2	250 V T 2.5 A
2	Ferrite core	1	For power cable
3	Instruction manual	1	Japanese, English, or Chinese (depends on the specification)
4	Instruction manual (RS485 communication or HART communication)	1	When you specified RS485 communication or HART communication. Language: Japanese, English, or Chinese (as specified)
5	Mounting bracket	1 set	For panel mount version : M8 sems screw (stainless steel), 4 pcs For pipe mount version : U bolt (stainless steel), 2 pcs : M8 nut, washer (stainless steel) 4 pcs : support 2 pcs

STORAGE CONDITIONS

Store the unit in a location that meets the following conditions:

- (1) Vibration, dust, dirt, and humidity are minimal.
- (2) A place not subjected to radiated heat from a heating furnace, etc.
- (3) The atmosphere is non-corrosive.
- (4) The ambient temperature is within the range from -30°C through 70°C (no condensation) and the ambient humidity is 95%RH or lower.

1. GENERAL

This manual describes the installation, operation, and the maintenance of the zirconia oxygen analyzer converter. Read it carefully before using the converter. For the detector, flow guide tube and ejector used with the converter, refer to relevant instruction manuals.

1.1 Direct insertion type zirconia oxygen analyzer

The direct insertion type zirconia oxygen analyzer consists of a direct insertion type zirconia detector (type ZFK) and converter (type ZKM).

The analyzer intended for the measurement of oxygen concentration in exhaust gas is used for combustion control.

Caution

Power voltage for the converter must conform to that for the detector to be connected. Don't use any power voltage different from the power specifications of the detector. Otherwise it may result in damage to the detector.

100/120V AC50/60Hz for ZFK8R□1

200/240V AC50/60Hz for ZFK8R□3

Operating environment

- 1) Operating temperature: -20 to 55°C
- 2) Operating humidity: 95%RH or less, non condensing
- 3) Power voltage: 100 to 120V AC 50/60Hz or 200 to 240V AC 50/60Hz
- 4) Pollution degree: 2
- 5) Installation category: II
- 6) Altitude: up to 2000m

2. OPERATING PARTS AND THEIR FUNCTIONS

2.1 Outline Drawing

(1) ZKMA

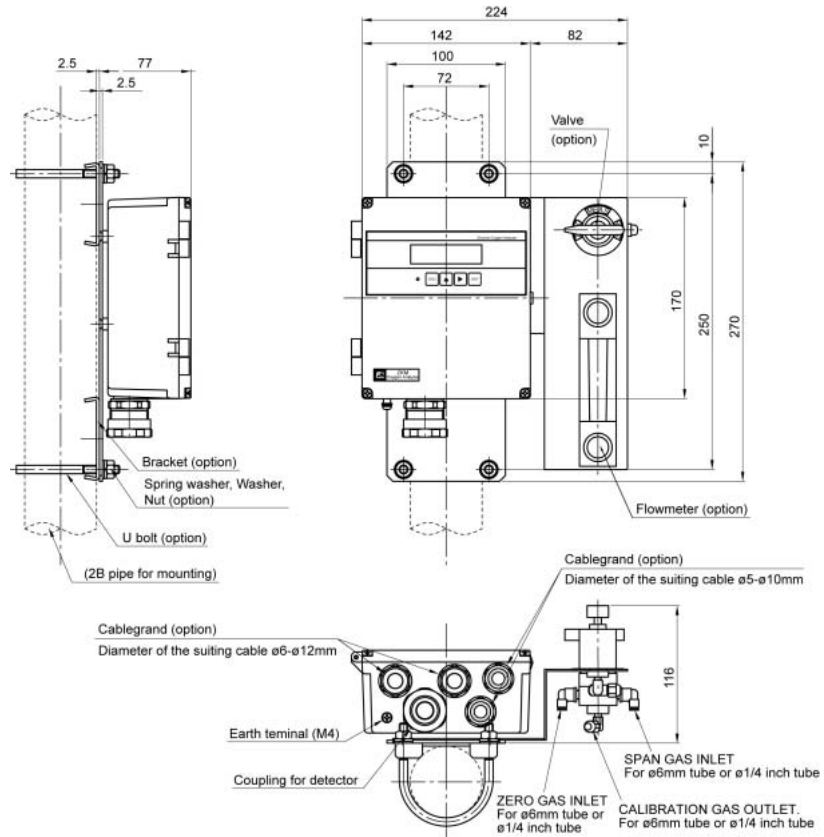

(2) ZKMB

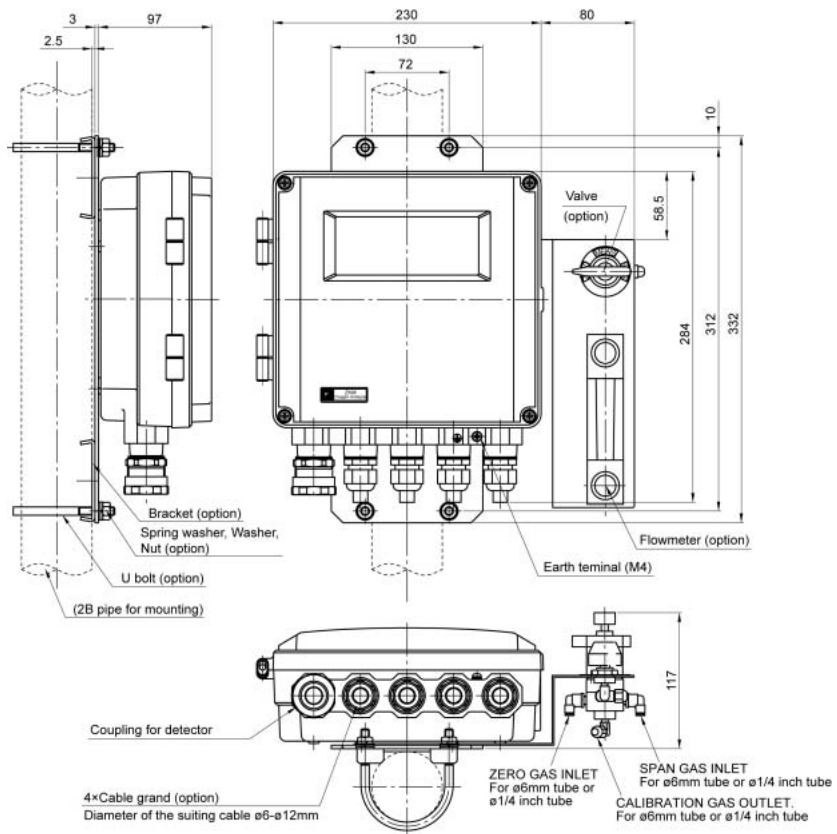

2.2 Terminal block

EXTERNAL TERMINAL (M3 screw)

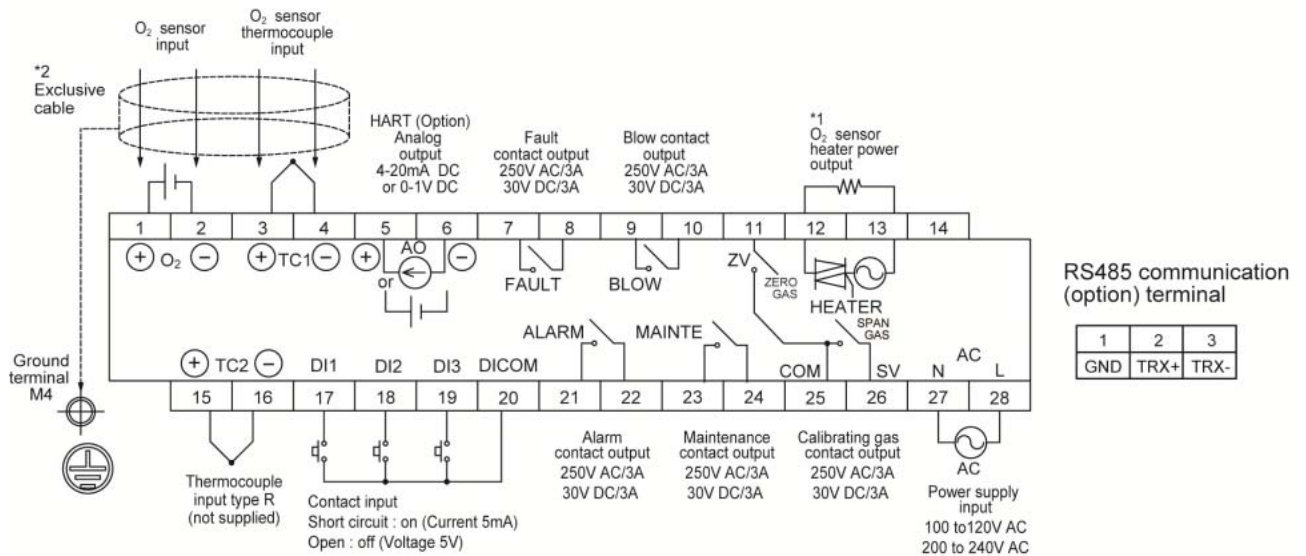

- Note 1) The heater power supply is the same as the converter power supply.
 Note 2) Be sure to connect the shield of the cable to the ground in the main body.
 Note 3) HART communication (option) uses a 4-20 mA analog output.

2.3 Display and operation panel

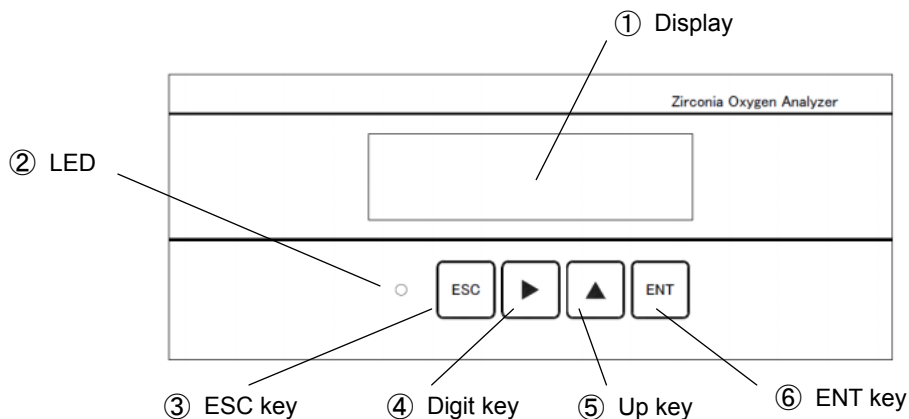

No.	Name	Description
①	Display unit	Displays the concentration value and setting values.
②	LED	Lights during power supply.
③	ESC key	Used to return to the previous screen or exit the setting.
④	Digit key	Used to change the setting values.
⑤	Up key	
⑥	ENT key	Used to determine the setting values or to start calibration or other operations.

2.4 Internal constitution

(1) ZKMA

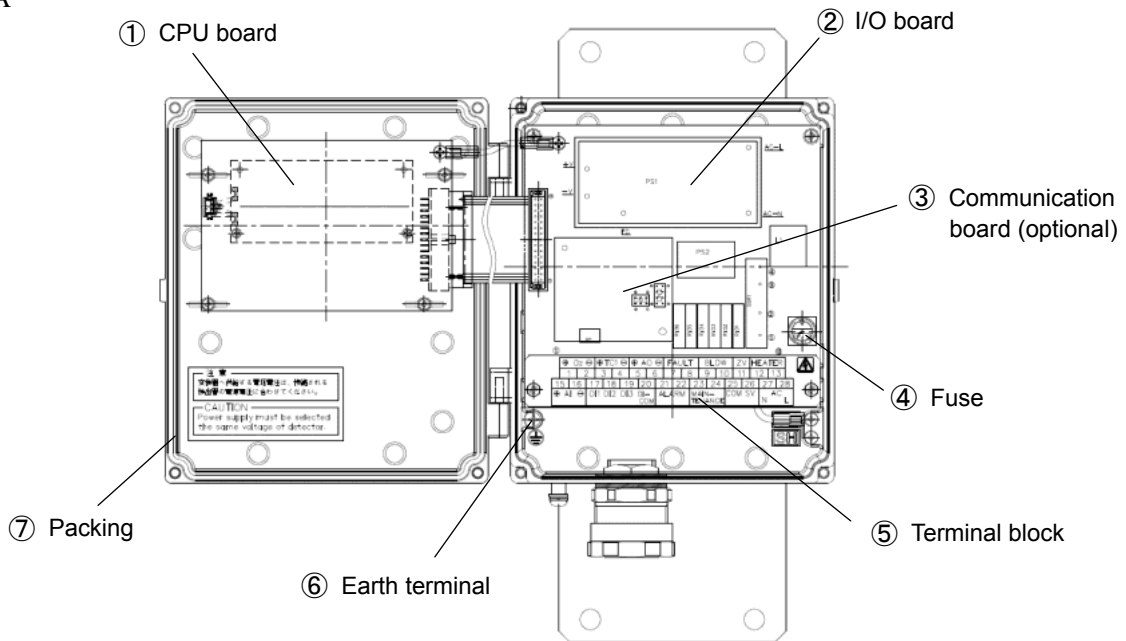

(2) ZKMB

You can see the CPU board, the I/O board, and the communication board (optional) if you remove the M3 screw and open the inner cover.

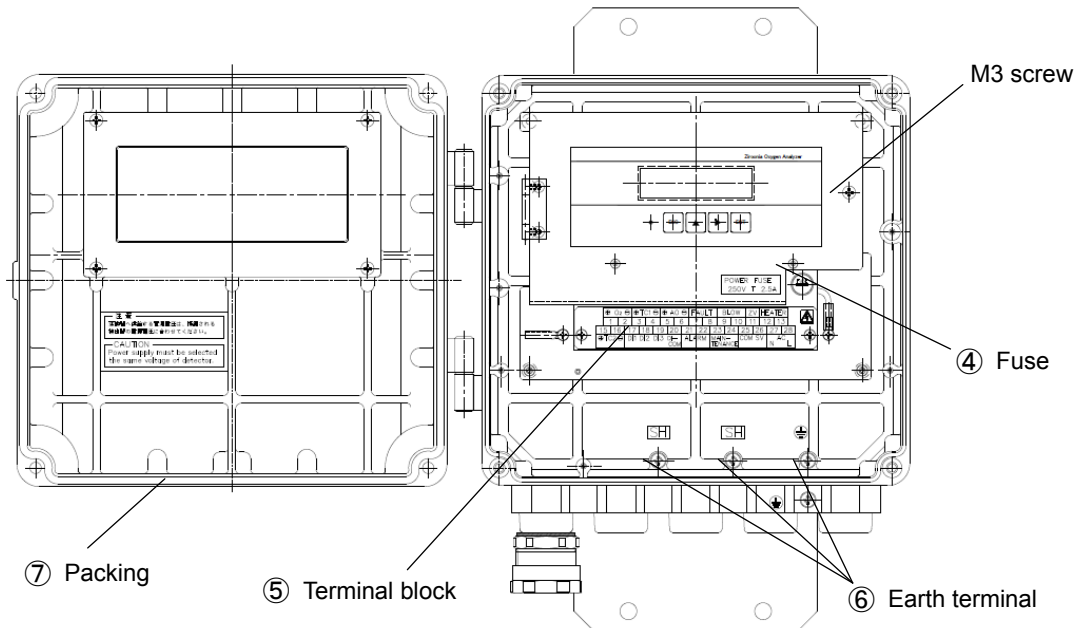

No.	Name	Description
①	CPU board	The liquid crystal display and the memory circuit are installed.
②	I/O board	The input/output circuit and the power circuit are installed.
③	Communication board	RS485 communication board or HART communication board is installed.
④	Fuse	Protects the CPU board and the I/O board from over-current.
⑤	Terminal block	Terminals for power cable, detector cable, and input/output cables.
⑥	Earth terminal	Used as frame gland (FG).
⑦	Packing	Protects electrical components from water and dust.

3. INSTALLATION

DANGER

- This unit is not explosion-proof type. Do not use it in an atmosphere of explosive gases. Otherwise serious accidents such as explosion or fire may result.

CAUTION

- For installation, observe the rule on it given in the instruction manual and select a place where the weight of converter can be endured. Installation at an unsuited place may cause turnover or fall and there is a risk of injury.
- Before transport, fix the door so that it will not open. Otherwise, the casing may be separated and fall to cause an injury.
- During installation work, care should be taken to keep the unit free from entry of cable chips or other foreign objects. Otherwise, it may cause fire, failure or malfunction.

3.1 Installation site

Install the converter in a place that satisfies the following conditions.

- (1) Space for periodic inspection and wiring work is available.
- (2) Vibration, dust, dirt, and humidity are minimal.
- (3) A place not subjected to radiated heat from a heating furnace, etc.
- (4) The atmosphere is non-corrosive.
- (5) Away from electrical devices that may cause noise trouble (such as motor and transformer), and equipment that may cause electromagnetic or electrostatic induction trouble.
- (6) A place where ambient temperature and humidity are -20 to $+55^{\circ}\text{C}$ and 95%RH or less.

Secure at least 100 mm of space between the converter and nearby wall. Also secure a space of opening the front cover for maintenance.

Secure a cable wiring space under the case.

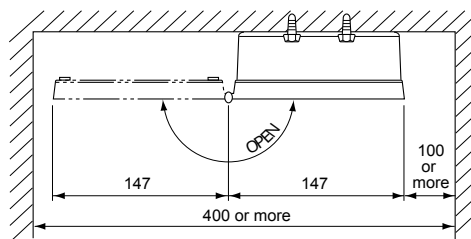

Unit: mm

Top view of mounting (ZKMA)

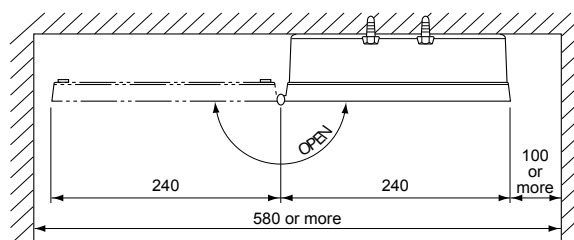

Unit: mm

Top view of mounting (ZKMB)

3.2 How to install the converter

3.2.1 Mounting on panel (ZKMA)

Unit: mm

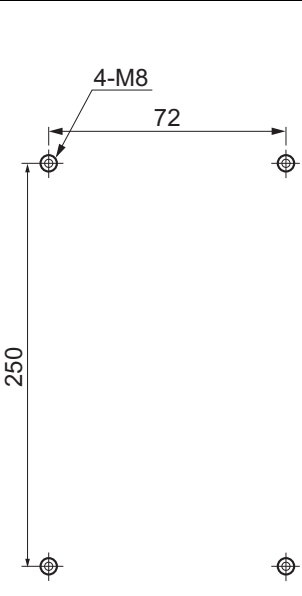
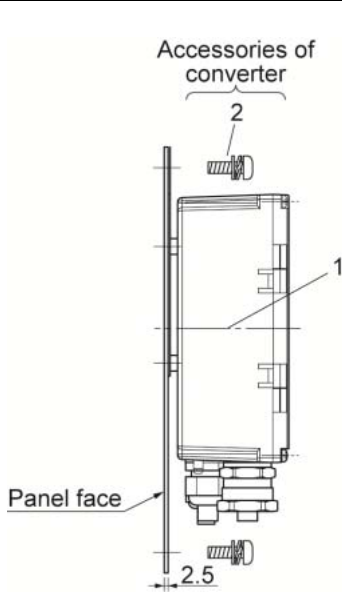
Mounting dimensions	Installation										
		<table border="1" style="width: 100%; border-collapse: collapse;"> <thead> <tr> <th>No.</th> <th>Name</th> <th>Quantity</th> </tr> </thead> <tbody> <tr> <td style="text-align: center;">1</td> <td>Converter</td> <td style="text-align: center;">1</td> </tr> <tr> <td style="text-align: center;">2</td> <td>Sems screw (M8×12)</td> <td style="text-align: center;">4</td> </tr> </tbody> </table> <p style="margin-top: 20px;">Code M8 Standard tightening torque 12.5 [N·m]</p>	No.	Name	Quantity	1	Converter	1	2	Sems screw (M8×12)	4
No.	Name	Quantity									
1	Converter	1									
2	Sems screw (M8×12)	4									

3.2.2 Pipe mounting (ZKMA)

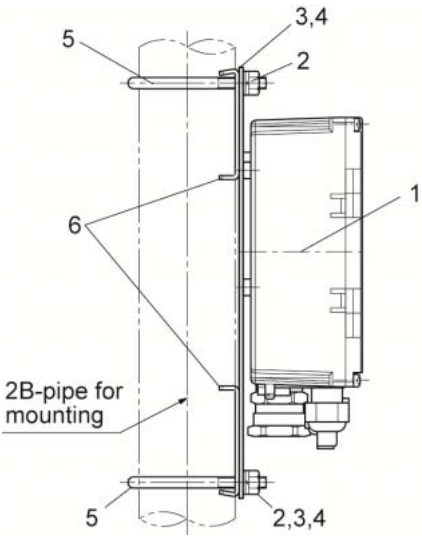
Installation																						
	<table border="1" style="width: 100%; border-collapse: collapse;"> <thead> <tr> <th>No.</th> <th>Name</th> <th>Quantity</th> </tr> </thead> <tbody> <tr> <td style="text-align: center;">1</td> <td>Converter</td> <td style="text-align: center;">1</td> </tr> <tr> <td style="text-align: center;">2</td> <td>Hexagon nut (M8)</td> <td style="text-align: center;">4</td> </tr> <tr> <td style="text-align: center;">3</td> <td>Spring washer (M8)</td> <td style="text-align: center;">4</td> </tr> <tr> <td style="text-align: center;">4</td> <td>Plain washer (M8)</td> <td style="text-align: center;">4</td> </tr> <tr> <td style="text-align: center;">5</td> <td>U bolt (M8)</td> <td style="text-align: center;">2</td> </tr> <tr> <td style="text-align: center;">6</td> <td>Support panel</td> <td style="text-align: center;">2</td> </tr> </tbody> </table> <p style="margin-top: 20px;">Code M8 Standard tightening torque 12.5 [N·m]</p>	No.	Name	Quantity	1	Converter	1	2	Hexagon nut (M8)	4	3	Spring washer (M8)	4	4	Plain washer (M8)	4	5	U bolt (M8)	2	6	Support panel	2
No.	Name	Quantity																				
1	Converter	1																				
2	Hexagon nut (M8)	4																				
3	Spring washer (M8)	4																				
4	Plain washer (M8)	4																				
5	U bolt (M8)	2																				
6	Support panel	2																				

3.2.3 Mounting on panel (ZKMB)

Unit: mm

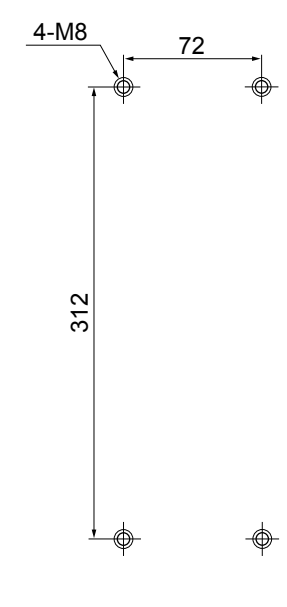
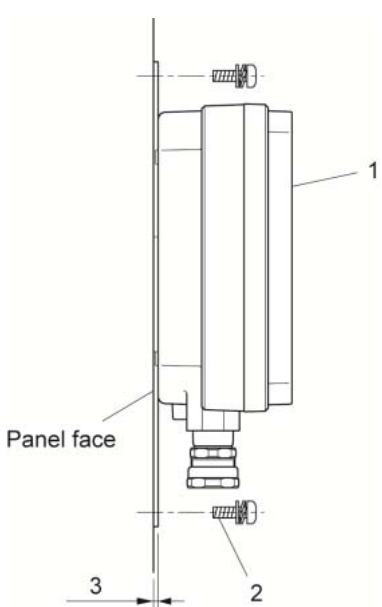
Mounting dimensions	Installation									
										
	<table border="1" style="width: 100%; border-collapse: collapse;"> <thead> <tr> <th>No.</th> <th>Name</th> <th>Quantity</th> </tr> </thead> <tbody> <tr> <td>1</td> <td>Converter</td> <td>1</td> </tr> <tr> <td>2</td> <td>Sems screw (M8×12)</td> <td>4</td> </tr> </tbody> </table> <p>Code M8 Standard tightening torque 12.5 [N·m]</p>	No.	Name	Quantity	1	Converter	1	2	Sems screw (M8×12)	4
No.	Name	Quantity								
1	Converter	1								
2	Sems screw (M8×12)	4								

3.2.4 Pipe mounting (ZKMB)

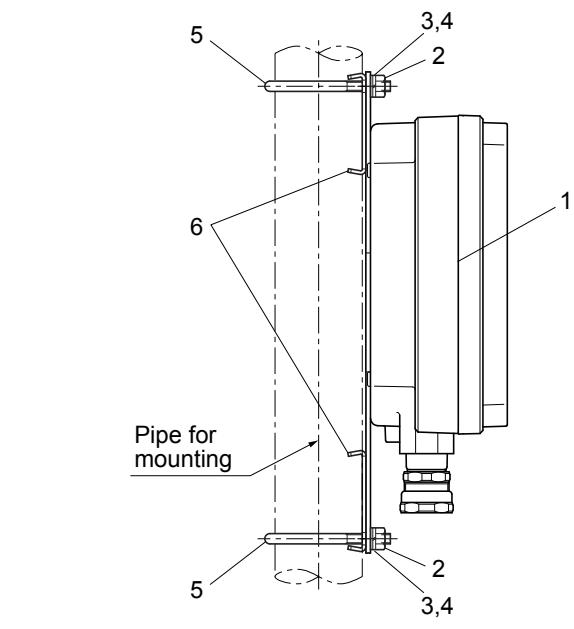
Installation																						
	<table border="1" style="width: 100%; border-collapse: collapse;"> <thead> <tr> <th>No.</th> <th>Name</th> <th>Quantity</th> </tr> </thead> <tbody> <tr> <td>1</td> <td>Converter</td> <td>1</td> </tr> <tr> <td>2</td> <td>Hexagon nut (M8)</td> <td>4</td> </tr> <tr> <td>3</td> <td>Spring washer (M8)</td> <td>4</td> </tr> <tr> <td>4</td> <td>Plain washer (M8)</td> <td>4</td> </tr> <tr> <td>5</td> <td>U bolt (M8)</td> <td>2</td> </tr> <tr> <td>6</td> <td>Support panel</td> <td>2</td> </tr> </tbody> </table> <p>Code M8 Standard tightening torque 12.5 [N·m]</p>	No.	Name	Quantity	1	Converter	1	2	Hexagon nut (M8)	4	3	Spring washer (M8)	4	4	Plain washer (M8)	4	5	U bolt (M8)	2	6	Support panel	2
No.	Name	Quantity																				
1	Converter	1																				
2	Hexagon nut (M8)	4																				
3	Spring washer (M8)	4																				
4	Plain washer (M8)	4																				
5	U bolt (M8)	2																				
6	Support panel	2																				

4. WIRING AND PIPING

DANGER

Do not energize the transmitter or equipment connected to the transmitter until all the wiring work are completed.

CAUTION

This product is compliant with CE marking.

If you need the product to meet the requirements of CE marking, carry out the wiring work according to the following instructions:

- Add an external switch or a circuit breaker to the power supply of the transmitter.
- Use the external switch or the circuit breaker that is rated to 5A and compliant with IEC947-1 or IEC947-3.
- We recommend installing the internal switch or the circuit breaker in the same room as the transmitter is installed.
- Place the internal switch or the circuit breaker within the reach of an operator, and indicate that it is the power switch of this product.

 : Turn off all the power supply during wiring work, otherwise electric shock may occur.

 : Be sure to ground the earth (Class D grounding).

4.1 Before wiring

- (1) Power voltage for the converter must conform to that for the detector to be connected.
- (2) Power supply wiring
 - Use 1.25sq 600V vinyl insulated cable (JISC3307) or equivalent as power supply cable.
 - Use the main ground wire longer than the L1 and L2 lines.
 - Fix the part of the AC cable sheath that is more inner than the cord bushing by 3 mm or more.
 - Use a solderless terminal for the end of the AC cable. For the main ground wire, use the solderless terminal whose core wire and sheath are caulked separately (double caulking).
 - Connect the ground wire to the following:
M4 screw / round terminal of the main ground wire / tooth lock washer / casing

Attach the solderless terminals to the grounding terminals with them between the tooth lock washer and sems screw.

(recommended tightening torque:
1.8 N·m)

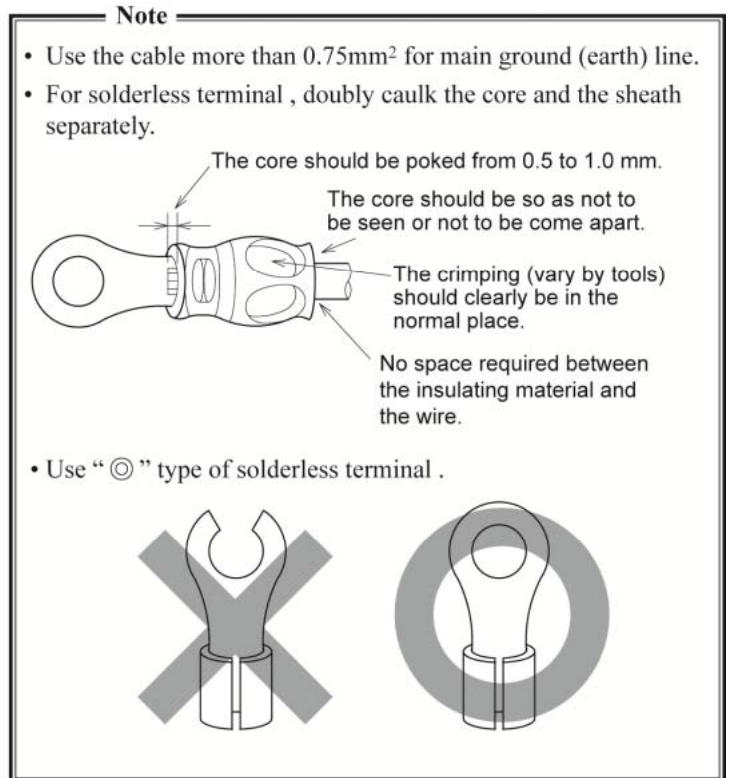
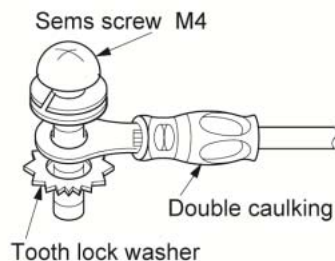

- (3) Provide adequate protection of the exclusive cable (6 cores in total), which connects the detector to converter, using wire protection tube, etc. Separate these cables from the power cable (noise prevention).
- (4) Keep the wire for output signals as far as possible (more than 30cm) from the power line and heavy current lines to prevent induced noise. Also, wherever possible use a shielded cable and earth one point of the shield.

Note) For connection of the lines to the external terminals, use of ring crimp solderless terminal with insulation sleeve is recommended.

4.2 Wiring to terminals

4.2.1 Wiring to power supply and detector

(1) <ZKMA>

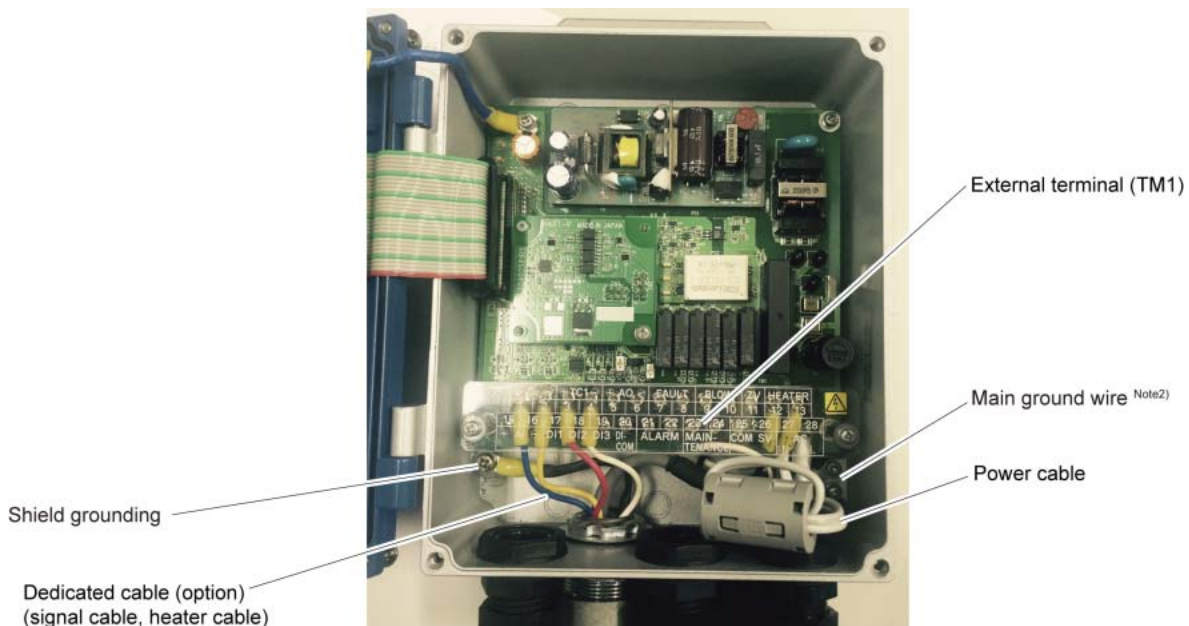

(2) <ZKMB>

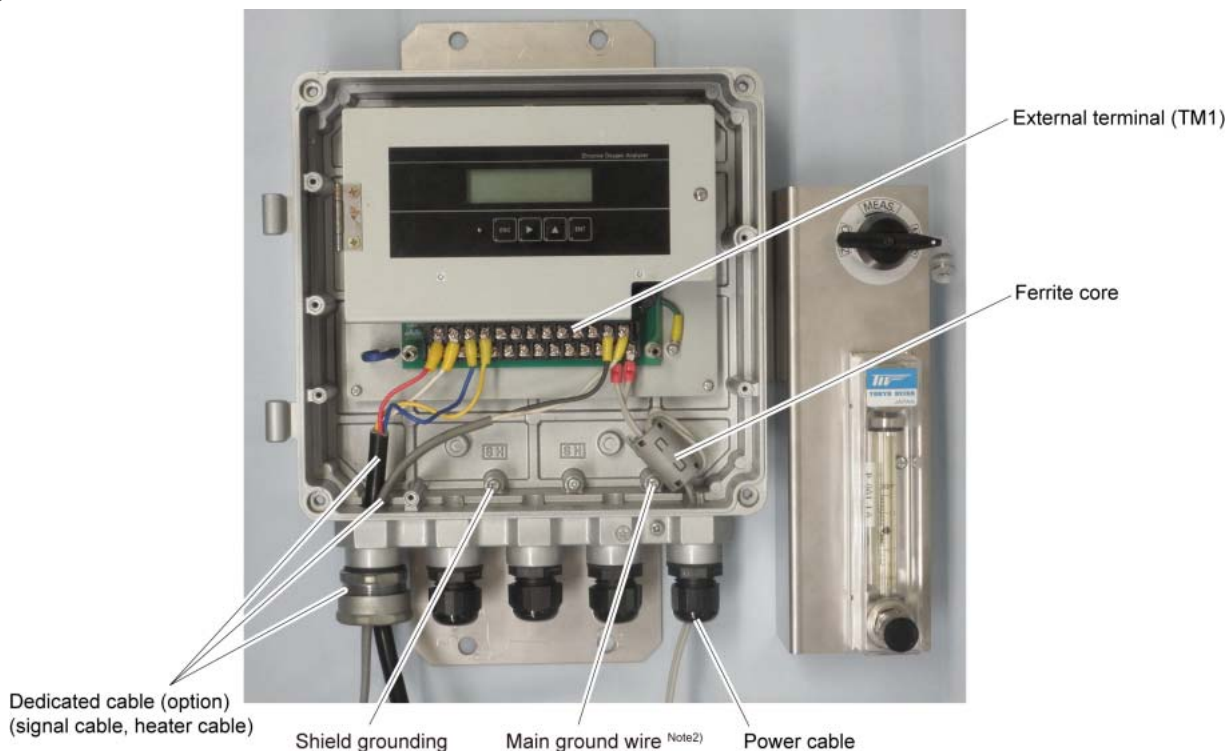

Note 1: Fix the exclusive cable (O₂ sensor input / O₂ sensor thermocouple input) with the cable gland so that its sheath is 10 mm or less.

When attaching the nut, turn it by hand until it does not move and then tighten it with a spanner by about 1/4 turn.

Note 2: Wire a protective earth to earth terminal of above figure. (Class D, grounding resistance: 100Ω or less)

Note 3: Wind the power cable around the ferrite core twice.

4.2.2 Cable gland and input and output lines

(1) <ZKMA>

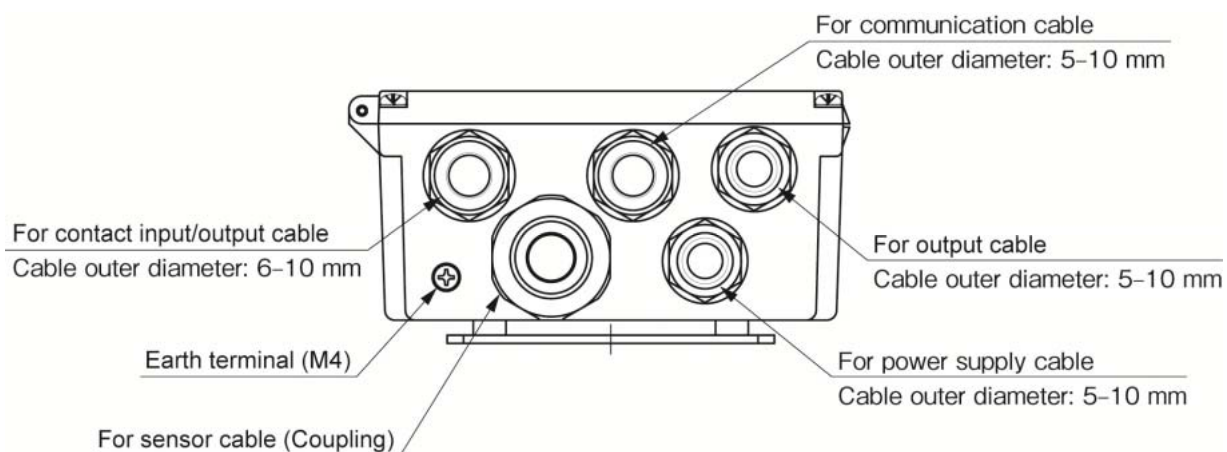

(2) <ZKMB>

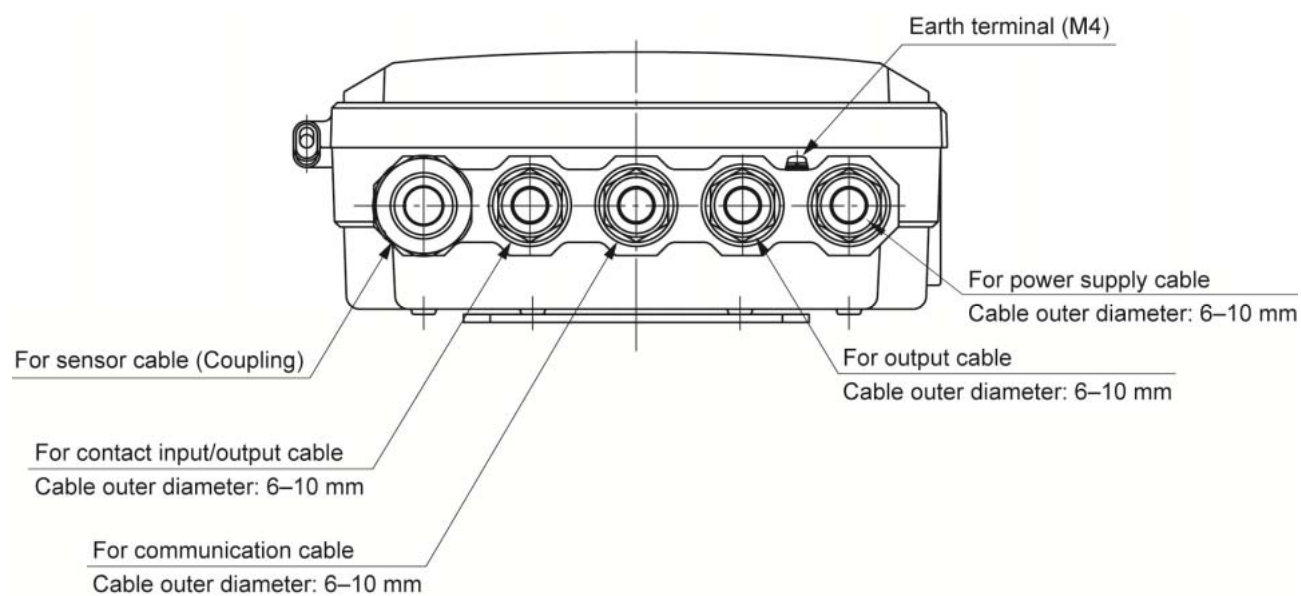

4.2.3 Allocation of the terminal block

EXTERNAL TERMINAL (M3 screw)

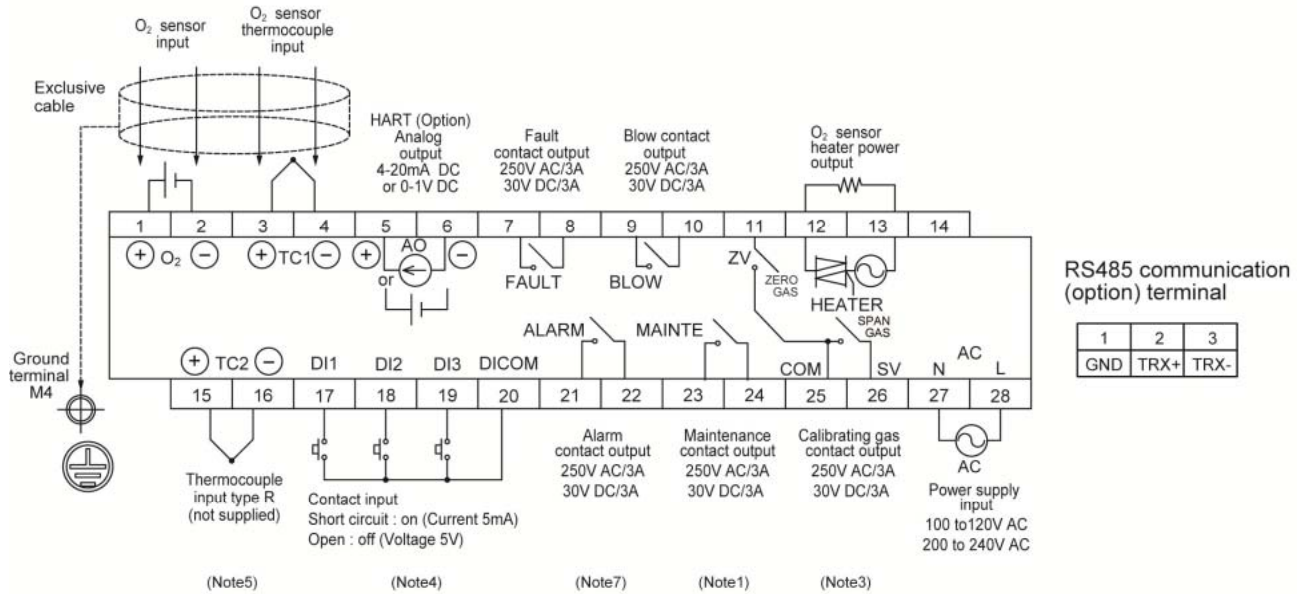

(Note 1) 23-24 Closed during calibration, blow down, sensor diagnosis, PID auto tuning.

(Note 2) 9-10 Closed during blowdown of detector. (option)

(Note 3) 25-11 Closed during zero calibration.

25-26 Closed during span calibration.



(Note 5) 15-16 R-type thermocouple input or type K thermocouple input.

When combustion efficiency display (option) is selected.

(Note 6) 7-8 Closed while disconnection of O₂ sensor input or thermocouple input, or heater control temperature error is detected.

(Note 7) 21-22 Closed while an oxygen concentration alarm is issued.

4.3 Wiring and piping diagram

4.3.1.1 Flow guide tube system

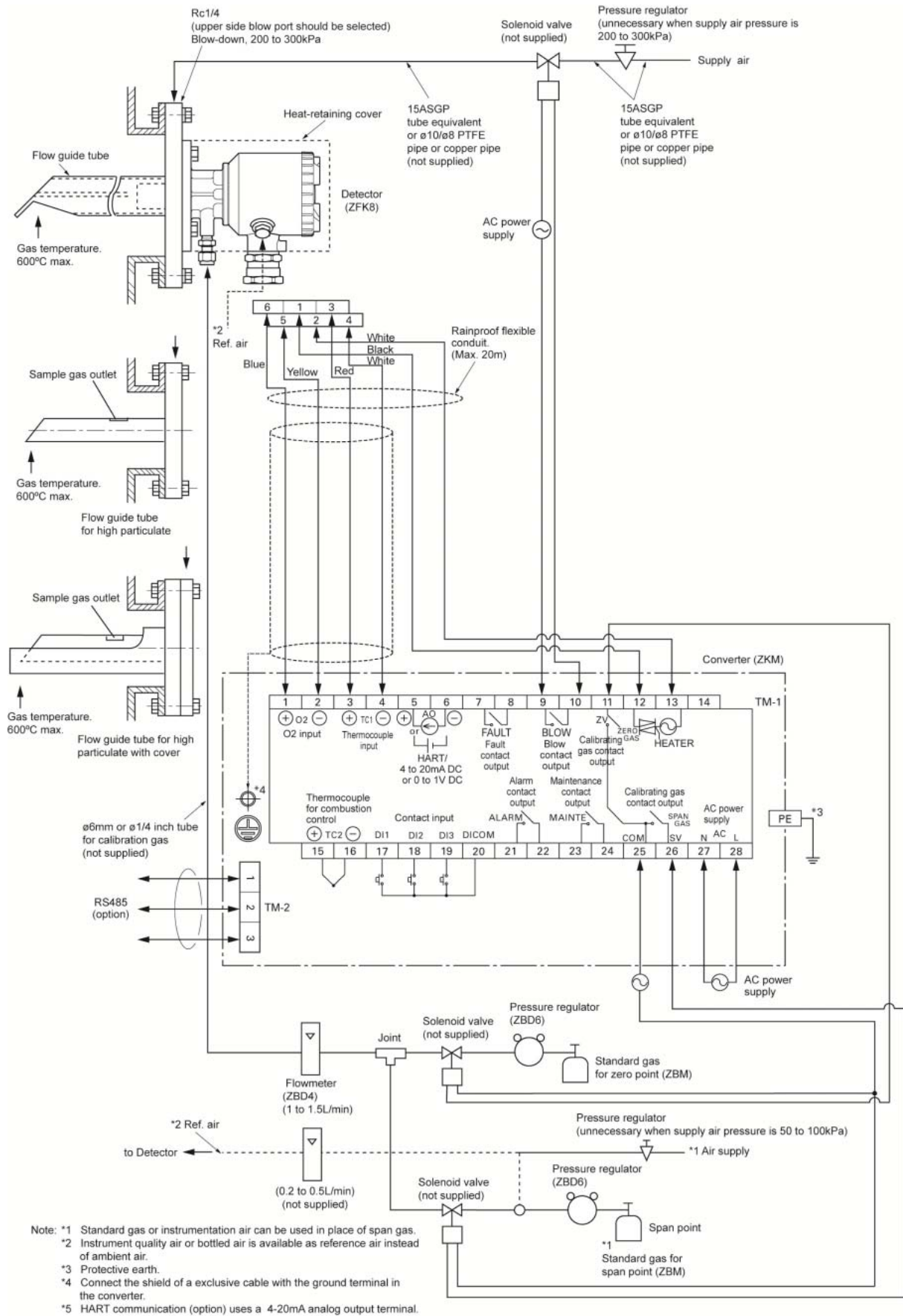

4.3.1.2 Flow guide tube system (with valve)

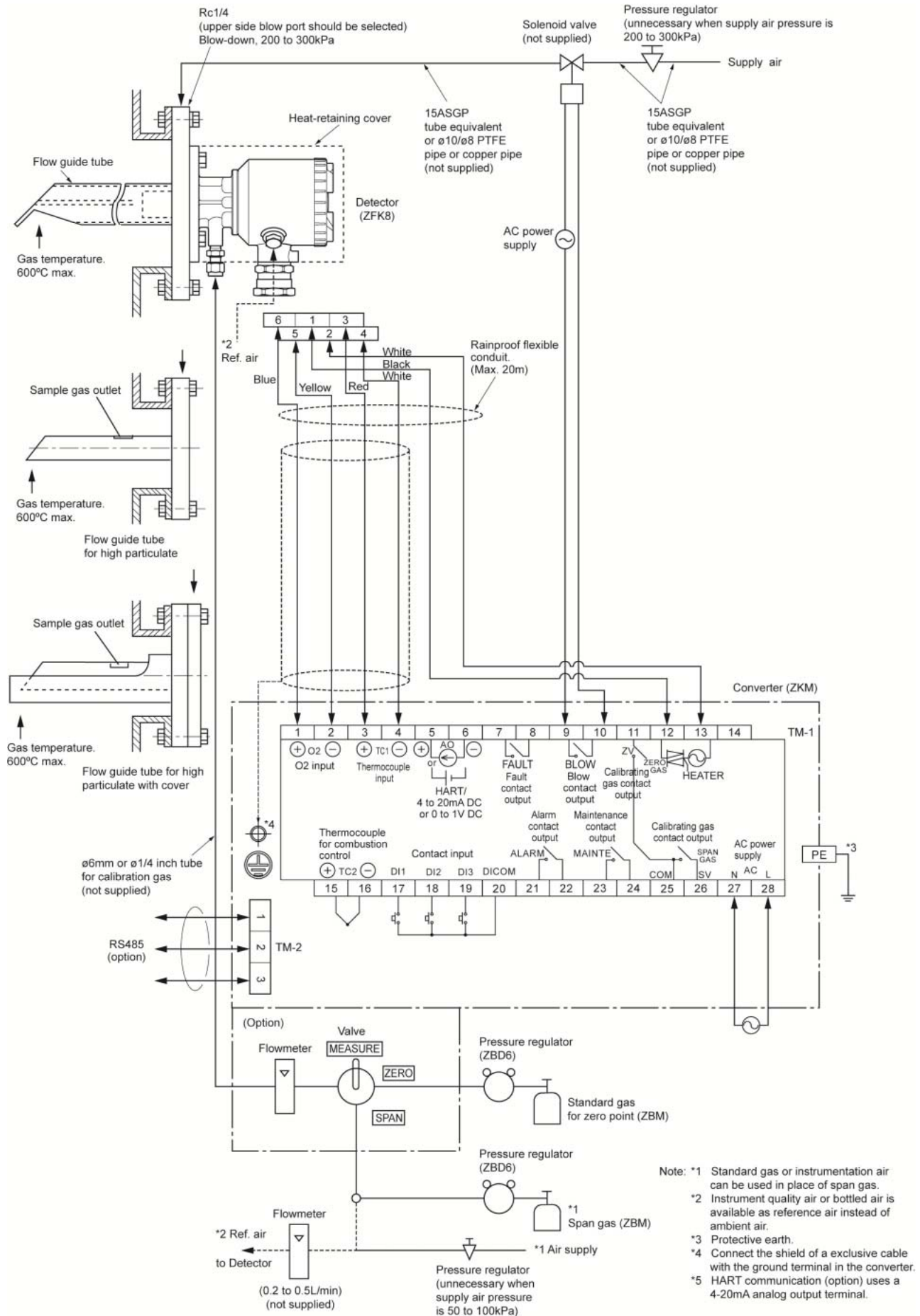

4.3.1.3 Ejector system

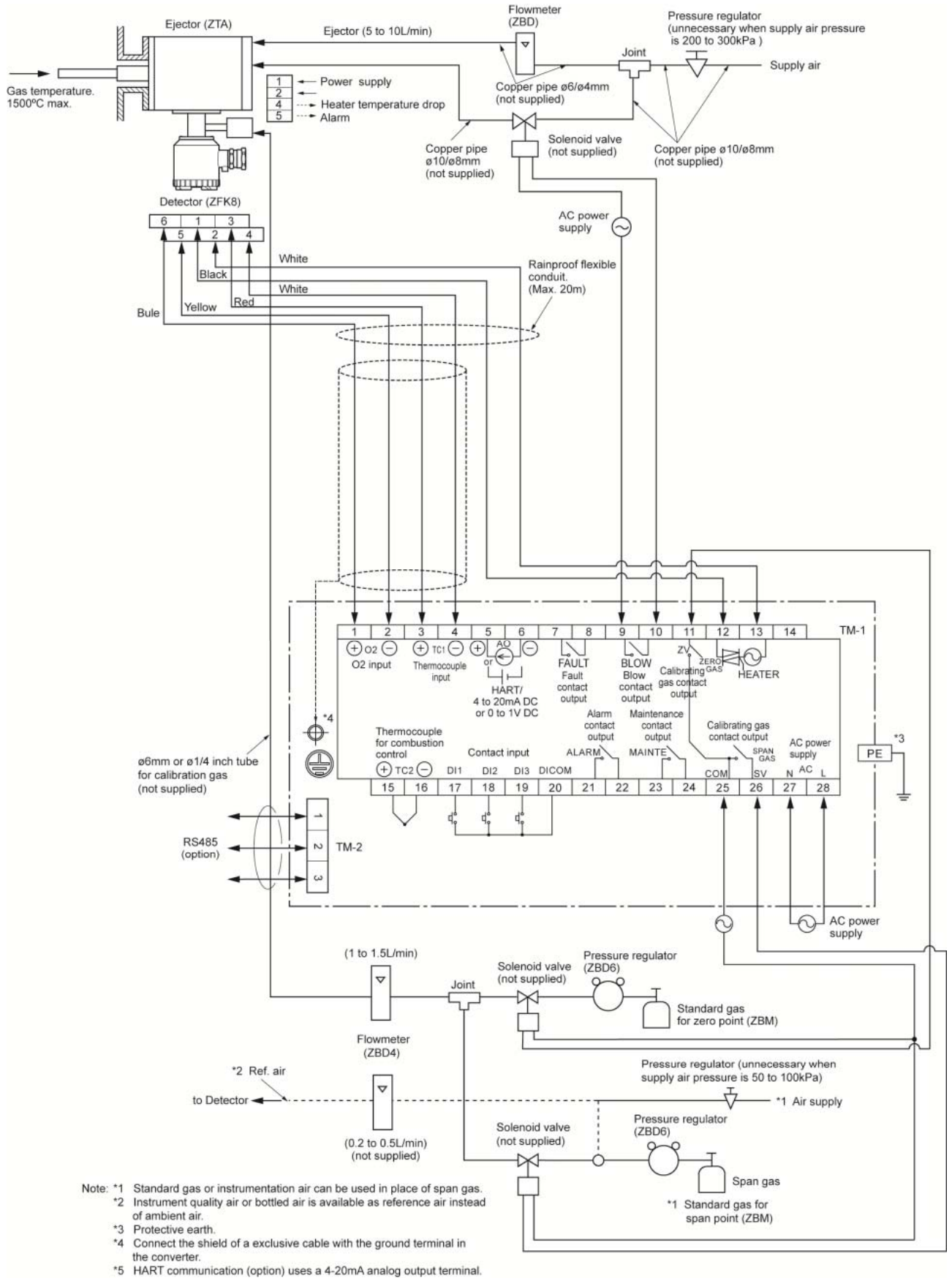

4.3.1.4 Ejector system (with valve)

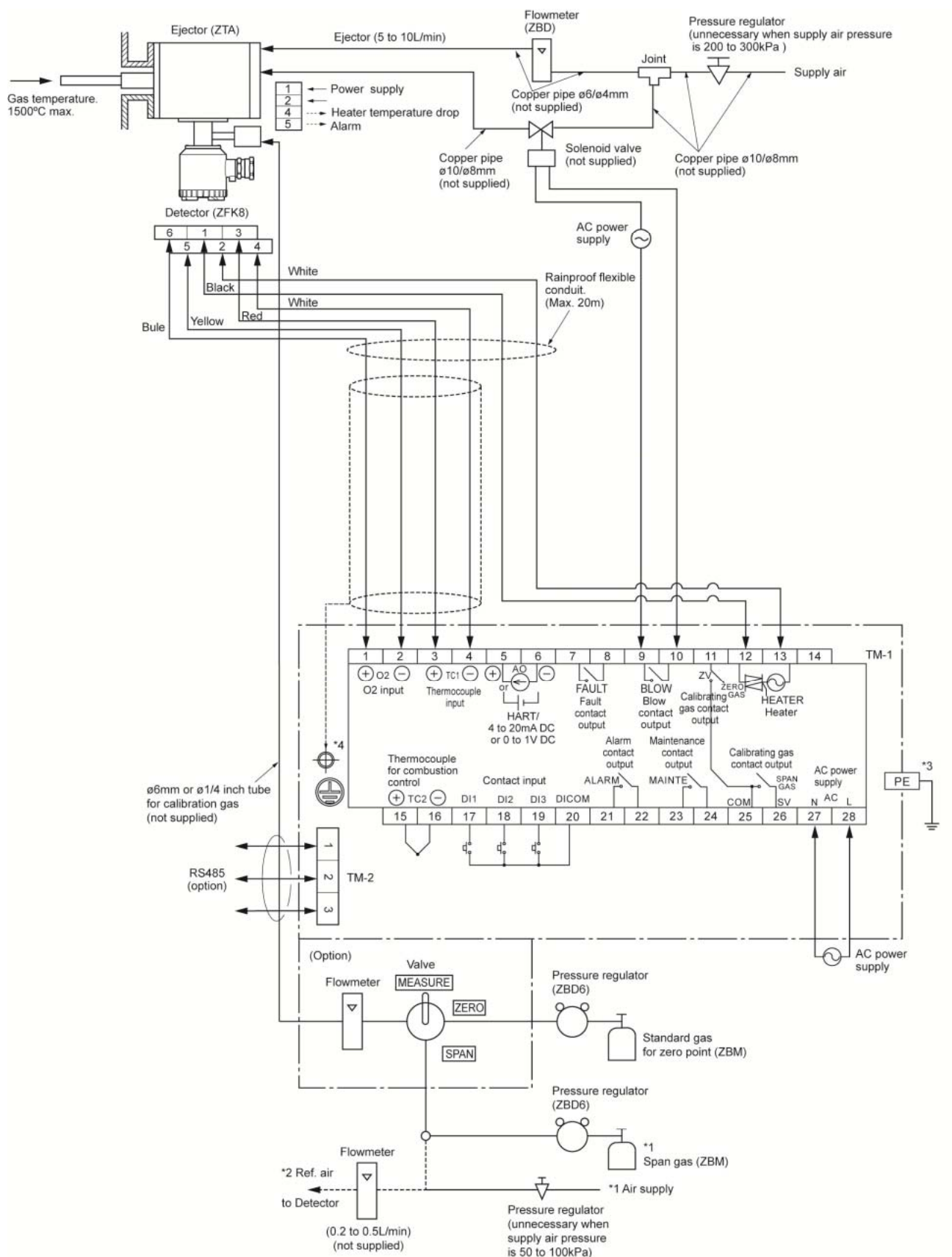

- Note: *1 Standard gas or instrumentation air can be used in place of span gas.
 *2 Instrument quality air or bottled air is available as reference air instead of ambient air.
 *3 Protective earth.
 *4 Connect the shield of a exclusive cable with the ground terminal in the converter.
 *5 HART communication (option) uses a 4-20mA analog output terminal.

4.4 Handling of standard gas (An article on separate order)

4.4.1.1 Operation

- (1) Make sure the handle is closed on the high pressure gas container, then detach the cap nut.
- (2) Attach the high pressure gas container using the cap nut with packing of the pressure reduction valve.
- (3) Make sure the secondary pressure adjusting valve is turned fully counterclockwise (pressure not applied) and the outlet needle is turned fully clockwise (closed), then open the handle.
- (4) Turn the secondary pressure adjusting valve clockwise and set to the normal value of 20 to 30 kPa, then open the outlet needle slowly to allow the gas to flow.

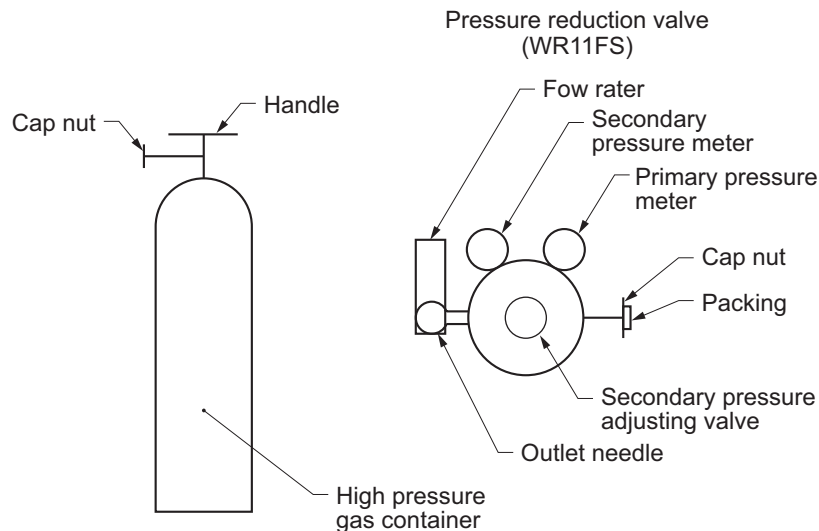

4.4.1.2 Piping

- (1) The gas outlet of the pressure reduction valve is of Rc 1/4 (internal thread). Prepare the joint and tube (such as $\phi 6 / \phi 4$ teflon tube).

4.4.1.3 Caution

- (1) Fasten securely, so there is no gas leakage from the pressure reduction valve connection or from threaded part of the joint.
- (2) Store high pressure gas containers in a place protected from direct sunlight and rain.
- (3) After use, be sure to close the handle.

5. OPERATION

5.1 Preparation for operation

Preparation can be performed after installation or on the bench.

- (1) Wiring check (Refer to “4.2”, “4.3”)



- (2) Confirmation of the power supply specifications (Please check the main power supply and the power supply voltage specification of the detector.)



- (3) Power ON.
The analyzer turns on when the power is supplied. (Refer to “2.4”)

OXYGEN ANALYZER
VER *.*.* YY/MM

The message shown left appears on the LCD screen.

WARM-UP
HEATER 234 °C

After about 6 seconds, the display is automatically switched to the warming-up screen.



- (4) Warm-up
Warm-up takes 10 minutes or less. Then the analyzer starts temperature control for the detector ZFK.
Note 1: If the temperature control completes within 10 minutes, the analyzer stops warm-up to start operation. When you first use the analyzer, proceed to the step 5 “PID auto tuning”.
Note 2: Even if the temperature control does not complete within 10 minutes, the analyzer stops warm-up to start operation, however, for 7 minutes after the warm-up stopped, the analyzer cannot detect the error of the heater temperature nor display it. (Carry out the step 5 “PID auto tuning” during this period.)



- (5) PID auto tuning
When you first use the analyzer, perform the PID auto tuning within 7 minutes after the stop of warm-up, in the state that the the detector ZFK is connected. Refer to Chapter 10 for the procedures of the PID auto tuning. When the PID auto tuning is finished, the analyzer perform warm-up again to check if temperature control is possible, and then starts operation.



- (6) Parameter setting
Move to each Menu with reference to the paragraph “5.2 Key operation flow diagram (outline)”, and set a necessary parameter. Refer to the paragraph “5.3 Initial parameter value table”.
If you need to change a parameter, refer to the “Chapter 10”.



- (7) Calibration
At the first operation, perform manual calibration after warm-up using a calibration gas.
Refer to “chapter 7” for calibration procedures.



(8) Auto calibration (option)
Automatic calibration may be performed at specified time intervals.
Refer to “7.3” for automatic calibration settings.



(9) Blowdown (option)
A flow guide tube blowdown feature prevents the flow guide tube from clogging due to dust in the gas stream.
Refer to “chapter 8” for operation procedures.



Operation

5.2 Key operation flow diagram (outline)

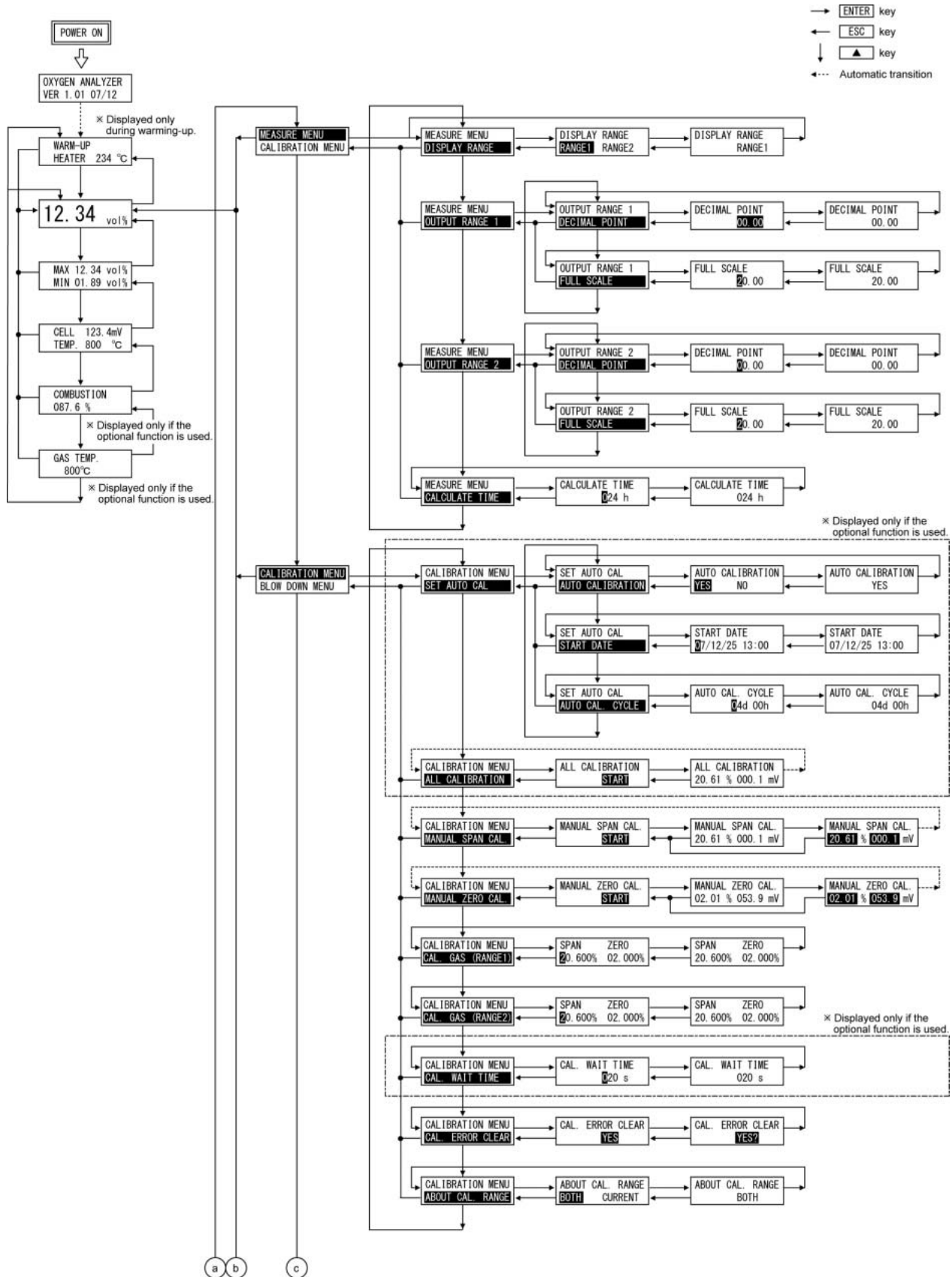

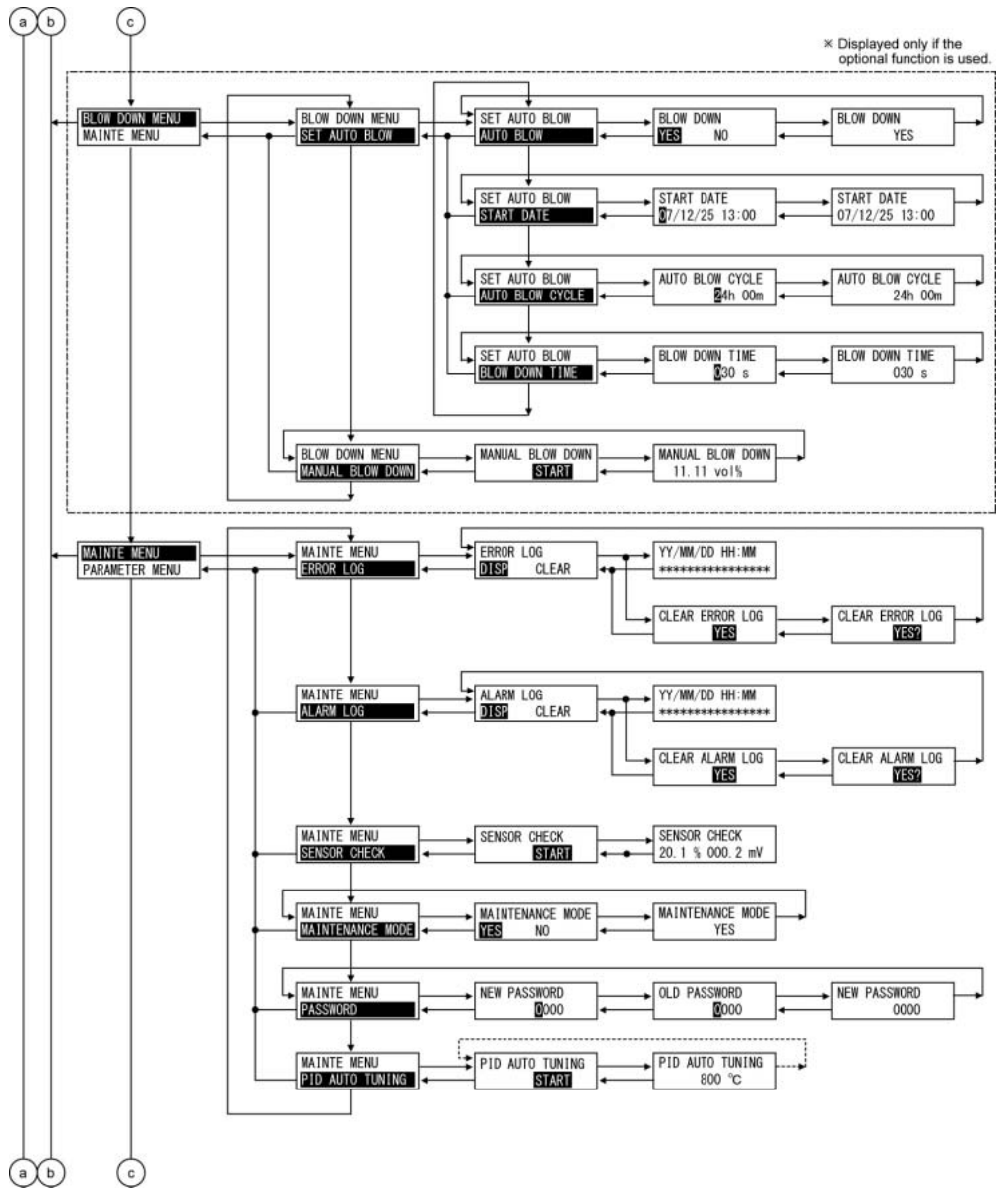

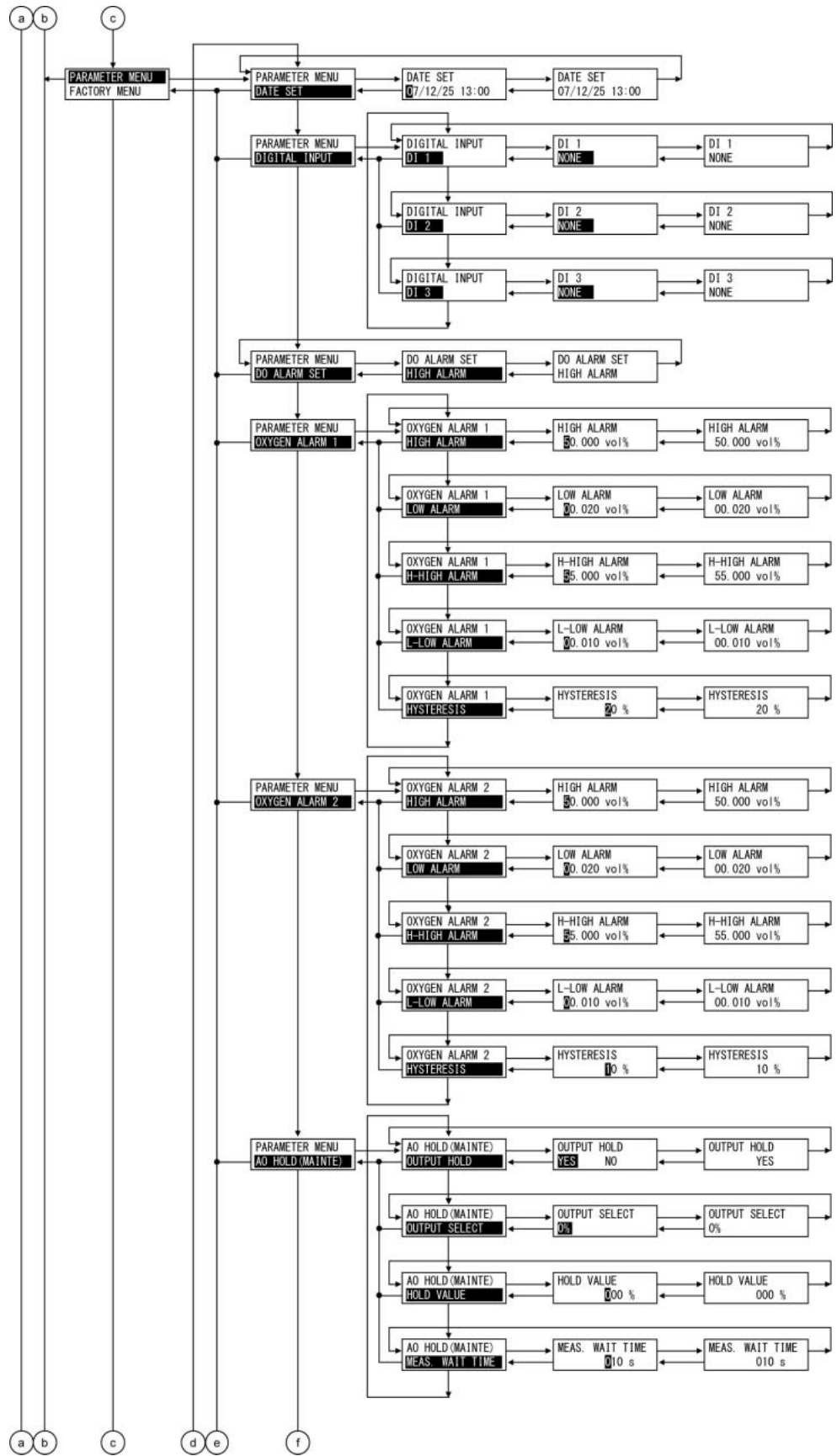

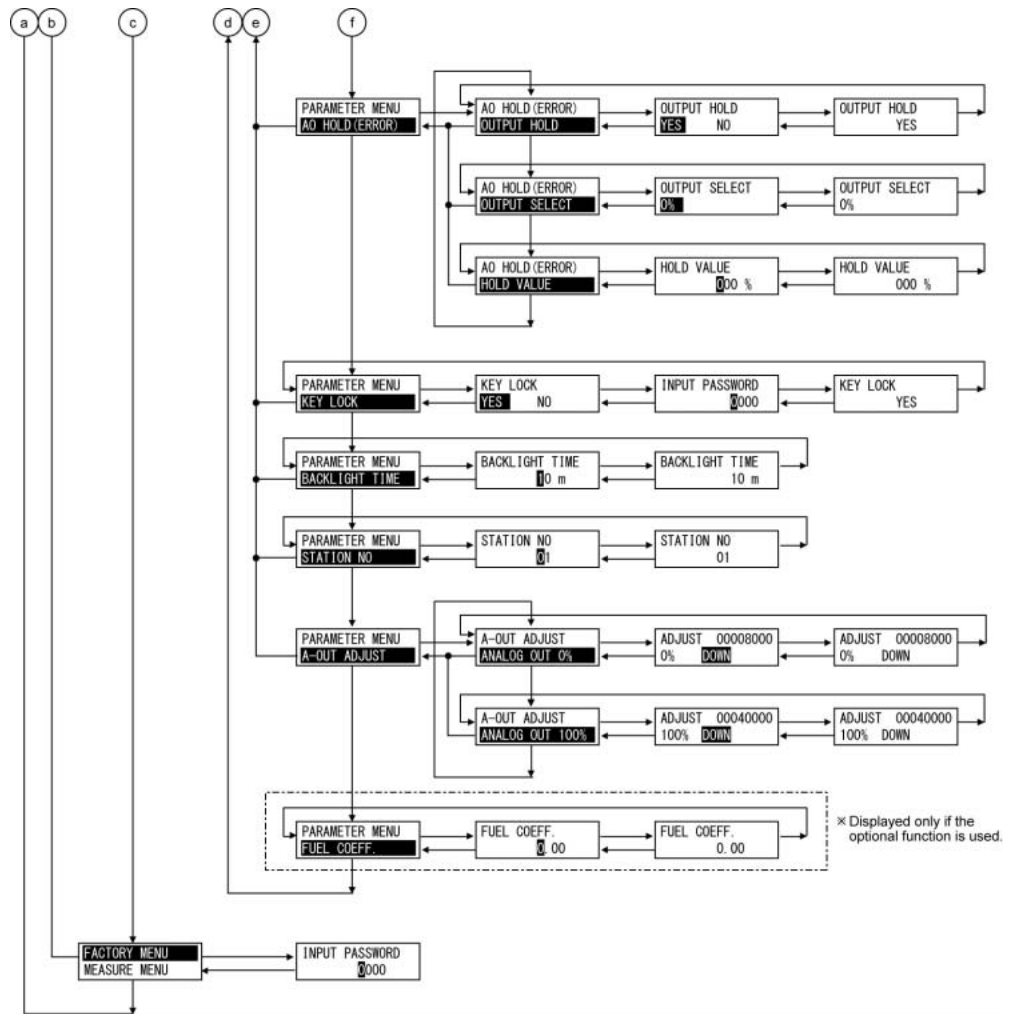

5.3 Initial parameter value table

5.3.1 Parameters related to measurement

Parameter setting	Displayed message	Range	Initial value	Reference paragraph
Display range	DISPLAY RANGE RANGE1 RANGE2	Range1 or Range2	Range-1	10.1.1
Decimal point position (Range1) (Range2)	DECIMAL POINT 00.00	[00.00] [0.000]	[00.00]	10.1.2
Full scale (Range1) (Range2)	FULL SCALE 25.00	2 to 50 in 1 vol% steps	25.00 vol%	10.1.3
Calculation time of maximum and minimum values	CALCULATE TIME 024 h	0 to 240 hour in 1-hour steps	24 hour	10.1.4

5.3.2 Parameters related to calibration

Parameter setting	Displayed message	Range	Initial value	Reference paragraph
Auto calibration function (Displayed if the option is provided.)	AUTO CALIBRATION YES NO	YES or NO	Invalid (Auto calibration function: Invalid)	10.2.1
Date and time for starting automatic calibration (Displayed if the option is provided.)	START DATE 99/01/01 00:00	Date and time in the future in the calendar	99/01/01 00:00	10.2.2
Automatic calibration cycle time (Displayed if the option is provided.)	AUTO CAL. CYCLE 07d 00h	00d 00h to 99d23h (h: 00 to 23)	07d 00h	10.2.3
Calibration gas concentration-1 calibration gas concentration-2	SPAN ZERO 20.600% 01.000%	Span: 00.010 to 50.000 vol% Zero: 00.010 to 25.000 vol% in 0.001 vol% steps	Span: 20.600 vol% Zero: 01.000 vol%	10.2.7
Calibration wait time	CAL. WAIT TIME 020 s	10 to 999 sec. in 1 sec. steps	300 sec.	10.2.8
Calibration range setting	ABOUT CAL. RANGE BOTH CURRENT	Set calibration range Current or both range	BOTH	10.2.10

5.3.3 Parameters related to blowdown (displayed if the option is provided)

Parameter setting	Displayed message	Range	Initial value	Reference paragraph
Automatic blowdown function	BLOW DOWN YES <input checked="" type="checkbox"/> NO	YES or NO	NO (The automatic blowdown function is invalid.)	10.3.1
Date and time for starting automatic blowdown	START DATE 99/01/01 00:00	Date and time in the future in the calendar	99/01/01 00:00	10.3.2
Automatic blowdown cycle time	AUTO BLOW CYCLE 24h 00m	00h 00m to 99h 59m (m: 00 to 59)	24h 00m	10.3.3
Blowdown time	BLOW DOWN TIME 030 s	0 to 999 sec. in 1 sec. steps	30 sec.	10.3.4

5.3.4 Parameters related to maintenance

Parameter setting	Displayed message	Range	Initial value	Reference paragraph
Maintenance mode	MAINTENANCE MODE YES <input checked="" type="checkbox"/> NO	YES or NO	NO	10.4.6
Password	NEW PASSWORD 0123	0000 to 9999	0000	10.4.7

5.3.5 Other parameters

Parameter setting	Displayed message	Range	Initial value	Reference paragraph
Current date and time	DATE SET 00/00/01 00:00	Date and time in the calendar	(14/01/01/ 00:00)	10.5.1
Contact inputs 1 to 3	DI 1 NONE	DI1 to DI3 [NONE] [BLOW DOWN ON] [HEATER OFF] [PROHIBIT CAL.] [REMOTE CAL.] [REMOTE HOLD] [CALCULATE REST] [OUTPUT RANGE]	DI1 [NONE] DI2 [NONE] DI3 [NONE]	10.5.2
Alarm contact output	DO ALARM SET ALARM NONE	[ALARM NONE] [HIGH ALARM] [LOW ALARM] [H-HIGH ALARM] [L-LOW ALARM] [H/L ALARM] [HH/LL ALARM]	[ALARM NONE]	10.5.3
Upper limit of oxygen concentration (Range-1) (Range-2)	HIGH ALARM 50.000 vol%	0.001 to 55.000 vol% in 0.001 vol% steps	50.000 vol%	10.5.4
Lower limit of oxygen concentration (Range-1) (Range-2)	LOW ALARM 00.020 vol%	0.001 to 55.000 vol% in 0.001 vol% steps	00.020 vol%	10.5.5
Upper 2 limit of oxygen concentration (Range-1) (Range-2)	H-HIGH ALARM 55.000 vol%	0.001 to 55.000 vol% in 0.001 vol% steps	55.000 vol%	10.5.6
Lower 2 limit of oxygen concentration (Range-1) (Range-2)	L-LOW ALARM 00.010 vol%	0.001 to 55.000 vol% in 0.001 vol% steps	00.010 vol%	10.5.7
Hysteresis (Oxygen concentration alarm) (Range-1) (Range-2)	HYSTERESIS 10 %	0 to 20 % in 1 % steps	10 %	10.5.8
Analog output hold function (Maintenance hold) (Error hold)	OUTPUT HOLD YES NO	YES or NO	NO (Analog output hold function is invalid.)	10.5.9 10.5.13
Output value of analog output hold (Maintenance hold) (Error hold)	OUTPUT SELECT 0%	[0 %] (4 mA/0V) [100 %] (20 mA/1V) [Last output value] [Setting value]	[0 %](4 mA/0V)	10.5.10 10.5.14
Setting the value of analog output hold (Maintenance hold) (Error hold)	HOLD VALUE 000 %	0 to 100 % in 1 % steps	0 %	10.5.11 10.5.15

Parameter setting	Displayed message	Range	Initial value	Reference paragraph
Measurement recovery time	MEAS. WAIT TIME 010 s	0 to 300 sec. in 1 sec. steps	10 sec.	10.5.12
Key lock function	KEY LOCK YES NO	YES or NO	No (Key lock function is invalid.)	10.5.16
Automatic OFF time	BACKLIGHT TIME 10 m	0 to 99 in 1-minute steps	10 minutes	10.5.17
Station No.	STATION NO 01	0 to 99	01	10.5.18
FUEL COEFFICIENT	FUEL COEFF. 0.70	0.00 to 1.99	0.70	10.5.21

6. OPERATION START AND STOP

6.1 Operation start

After correct wiring and piping has been completed, turn on the converter to start measurement.
Note: 10 min. of warm-up time is necessary after power ON.

Caution of before starting operation

- (1) Furnace operation should be started after an elapsed time of 10 minutes from the point of turning "ON" the power supply of this unit
- (2) When a detector is to be installed in a furnace already in operation, take care to blow out harmful gas from the furnace and then install the fully warmed up detector quickly.
- (3) Control of detector temperature may get unstable depending on the ambient temperature, power supply voltage, and other conditions. In such a case (especially when you first use the analyzer), perform PID auto-tuning after the stop of warm-up (Refer to 10.4.8 PID auto tuning).

6.2 Operation stop

6.2.1.1 When a process (furnace etc.) is to be shutdown for a short time i.e. a week or so

It is strongly recommended to keep the detector in operation to avoid possible deterioration of platinum electrodes in the detector and detector break-down due to repetition of power ON-OFF in a moisture absorption state.

In case of the detector with an ejector (option), shutdown the air source.

6.2.1.2 When a process (furnace etc.) is to be shutdown for a long time

Turn OFF the power switch of the instrument after gas in the furnace has been replaced completely by ambient air.

6.3 Actions during operation

While the instrument is operating, the following displays can be changed.

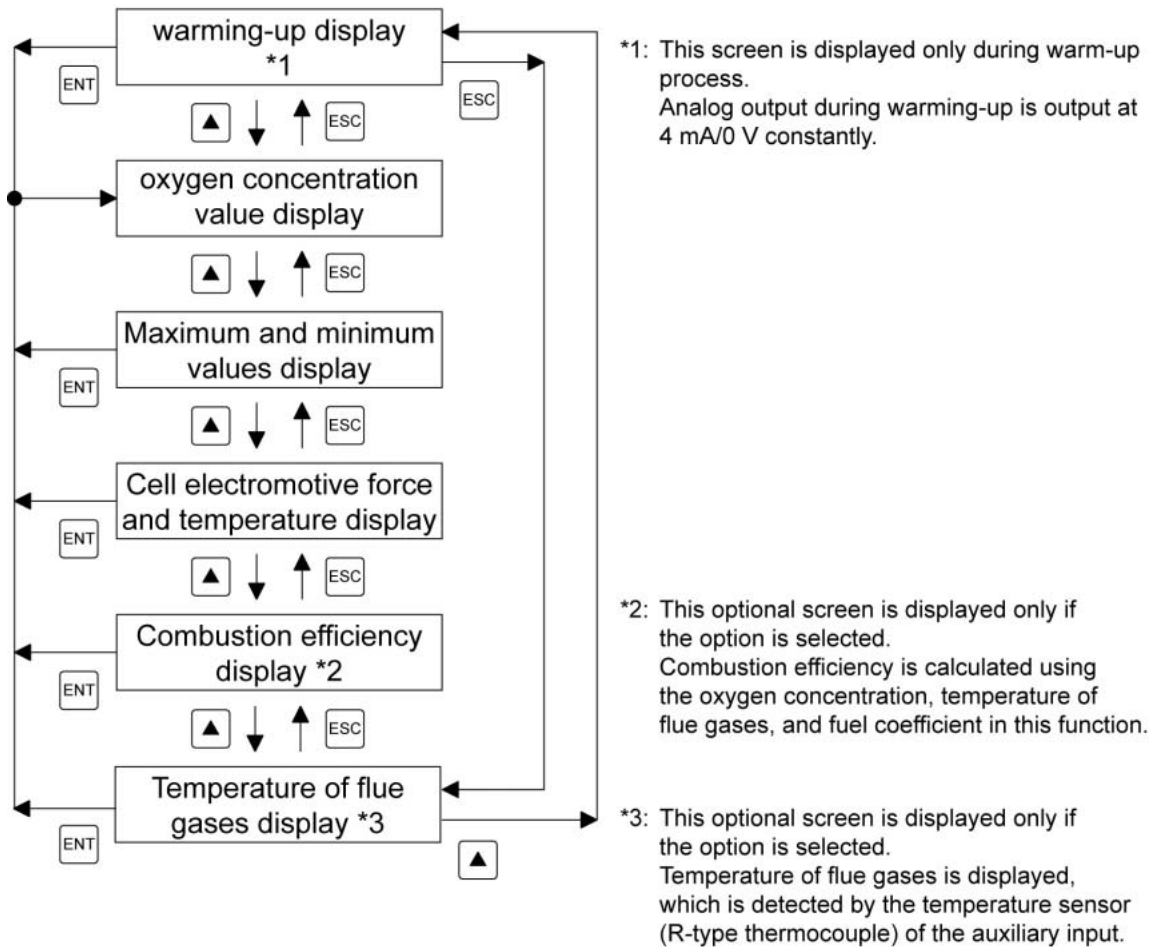

6.4 Check the contents of display

The condition of the unit is displayed on the left of the LCD with three letters. The maximum of three items are displayed on one display. If there are four or more items, “▼” is displayed at the bottom of the screen. Scroll the screen with the  key to display the fourth and subsequent items.

The unit displays the following three pieces of information:

- (1) Condition information (“6.4.1”), (2) Error information (“6.4.2”), (3) Alarm information (“6.4.3”)

6.4.1 Check of state information

Display message	State	Remarks
WUP	Warm-up	Appears during warm-up
CAL	Auto calibration	Appears during auto calibration
S	Span calibration	Displayed together with “CAL” or “RIC” during span calibration.
Z	Zero calibration	Displayed together with “CAL” or “RIC” during zero calibration.
SCK	Sensor check	Displayed during sensor check.
BLW	Automatic blowdown	Displayed during automatic blowdown.
RIC	Rich mode	Combustion efficiency option Displayed when electromotive force is 200mV but no more than 260mV
KYL	Key Lock	Displayed during key lock
RHO	Remote heater is off.	Displayed while remote heater is off.
RCP	Remote calibration is prohibited.	Displayed while remote calibration is prohibited.
RAH	Remote analog output hold	Displayed during remote analog output hold.
RCL	Remote calibration	Displayed during remote calibration.
RBL	Remote blowdown	Displayed during remote blowdown.
OVR	Over range	Displayed when an input is out of the range.

6.4.2 Checking the error information

Display message	State	Remarks
Er1	Fault of heater temperature	Appears when control temperature of the heater exceeds the set range. The heater control is stopped.
Er2	Disconnection detection	Appears when disconnection is detected at the sensor, or thermocouples for temperature control. The heater control is stopped.
Er3	Sensor error	Appears when the A/D value is saturated.
Er4	Span calibration error	Appears when the span calibration is abnormal. (The calibration gas is unstable. / The calibration factor setting is inappropriate.)
Er5	Zero calibration error	Appears when the zero calibration is abnormal. (The calibration gas is unstable. / The calibration factor setting is inappropriate.)

6.4.3 Checking the alarm information

Display message	State	Remarks
ALM	Oxygen concentration error	Appears when the oxygen concentration exceeds any of specified HH / High / Lower / LL limit values. (Refer to “10.5.4” to “10.5.8”)
H	High limit error	Appears together with ALM.
L	Lower limit error	Appears together with ALM.
HH	HH limit error	Appears together with ALM.
LL	LL limit error	Appears together with ALM.

You can select one of the following seven alarms to output to the alarm contact (Contact No. 21 and 22 of the external terminal blocks) when an oxygen concentration error occurs.

- (1) [Not used] : No alarm is output to the contact output.
- (2) [High limit alarm] : Alarm contact is output when an high limit alarm occurs.
- (3) [Lower limit alarm] : Alarm contact is output when a lower limit alarm occurs.
- (4) [HH limit alarm] : Alarm contact is output when an HH limit alarm occurs.
- (5) [LL limit alarm] : Alarm contact is output when a LL limit alarm occurs.
- (6) [High/lower limit alarm] : Alarm contact is output when an high or lower limit alarm occurs.
- (7) [HH / LL limit alarm] : Alarm contact is output when an HH or LL limit alarm occurs.

6.5 Oxygen detector standard output voltage

O ₂ concentration (%)	Output value (mV)	O ₂ concentration (%)	Output value (mV)	O ₂ concentration (%)	Output value (mV)
0.01	176.38	5.0	32.73	25.0	-4.475
0.1	123.15	10.0	16.71	30.0	-8.689
0.5	85.95	15.0	7.333	40.0	-15.34
1.0	69.93	20.0	0.683	50.0	-20.50
1.5	60.56	20.6	0	–	–
2.0	53.91	21.0	-0.445	–	–

7. CALIBRATION

In order to maintain good accuracy, proper calibration using standard gas is necessary. The following 4 methods of calibration are provided.

- (1) Manual calibration (“7.2”), (2) Auto calibration (option) (“7.3”),
- (3) Remote calibration (“7.4”), (4) All calibration (option) (“7.5”)

7.1 Preparation

- Check of piping and wiring
Perform wiring and piping correctly referring to Item “4.3”. At this time, the main valve of standard gas should be left open. Since high pressure is present at piping connections, use cap nut joints and take special care with regard to air-tightness. Calibration gas flow should be 1.5 ± 0.5 L/min.
- Setting of calibration gas concentration
Referring to “10.2.7 Calibration gas setting” set the oxygen concentration in standard gas cylinder to be used.
- Setting of calibration range
Set the range for calibration according to “10.2.10 Operation setting screen of calibration range.”

7.2 Manual calibration

Description

- Span/zero is calibrated once by key operation.
- Calibration must be made in the order of span and zero.
- Perform calibration after a calibration gas is supplied to the detector and the output signal of the detector becomes stable.
- If the unit does not have an auto calibration function, the operator shall perform open and close operations, or adjust the flow rate of calibration gas.
- During calibration, if the analog output hold function (maintenance hold) is enabled, the analog output signal is held at the set value. Even after the calibration, the hold is maintained during the set time as a measurement recovery time.

Procedure	Operation (example)	Executes span calibration and zero calibration.	
	Key operation	Description	Displayed message (LCD)
(1)	ENT	Display the screen on the right in accordance with the key operation summary and press the ENT key, the manual span calibration screen appears.	<div style="border: 1px solid black; padding: 5px; width: fit-content; margin: auto;"> CALIBRATION MENU MANUAL SPAN CAL. </div>
(2)	ENT	Press the ENT key to perform manual span calibration. If supplying calibration gas manually (without the auto-calibration function) The operator shall open the span gas valve manually and adjust the flow rate to 1.5 ± 0.5 L/min. In the case of unit with the auto calibration function, an external solenoid valve can be driven by using the contact output signal from the terminal block.	<div style="border: 1px solid black; padding: 5px; width: fit-content; margin: auto;"> MANUAL SPAN CAL. START </div>
(3)		Oxygen concentration value and cell electromotive force are displayed. Wait until the oxygen concentration is stabilized.	<div style="border: 1px solid black; padding: 5px; width: fit-content; margin: auto;"> MANUAL SPAN CAL. 20.61 % 000.1 mV </div>
(4)	ENT	Press the ENT key to determine the span calibration factor. During the process, the oxygen concentration value and cell electromotive force are highlighted.	<div style="border: 1px solid black; padding: 5px; width: fit-content; margin: auto;"> MANUAL SPAN CAL. 20.61 % 000.1 mV </div>
(5)		After the calibration is completed, the display returns to the screen on the right.	<div style="border: 1px solid black; padding: 5px; width: fit-content; margin: auto;"> CALIBRATION MENU MANUAL SPAN CAL. </div>
(6)		If the operator opened the span gas valve manually, close the valve.	
(7)	ENT	Display the screen on the right in accordance with the key operation summary and press the ENT key, the manual zero calibration screen appears.	<div style="border: 1px solid black; padding: 5px; width: fit-content; margin: auto;"> CALIBRATION MENU MANUAL ZERO CAL. </div>

(8)	<div style="border: 1px solid black; display: inline-block; padding: 2px;">ENT</div>	<p>Press the <div style="border: 1px solid black; display: inline-block; padding: 2px;">ENT</div> key to perform manual zero calibration. If supplying calibration gas manually (without the auto-calibration function) The operator shall open the span gas valve manually and adjust the flow rate to 1.5 ± 0.5 L/min. In the case of unit with the auto calibration function, an external solenoid valve can be driven by using the contact output signal from the terminal block.</p>	<div style="border: 1px solid black; padding: 5px;"> MANUAL ZERO CAL. <div style="border: 1px solid black; display: inline-block; padding: 2px;">START</div> </div>
(9)		<p>Oxygen concentration value and cell electromotive force are displayed. Wait until the oxygen concentration is stabilized.</p>	<div style="border: 1px solid black; padding: 5px;"> MANUAL ZERO CAL. 2.01 % 053.9 mV </div>
(10)	<div style="border: 1px solid black; display: inline-block; padding: 2px;">ENT</div>	<p>Press the <div style="border: 1px solid black; display: inline-block; padding: 2px;">ENT</div> key to determine the zero calibration factor. During the process, the oxygen concentration value and cell electromotive force are highlighted.</p>	<div style="border: 1px solid black; padding: 5px;"> MANUAL ZERO CAL. <div style="border: 1px solid black; display: inline-block; padding: 2px;">2.01</div> % <div style="border: 1px solid black; display: inline-block; padding: 2px;">053.9</div> mV </div>
(11)		<p>After the calibration is completed, the display returns to the screen on the right.</p>	<div style="border: 1px solid black; padding: 5px;"> CALIBRATION MENU <div style="border: 1px solid black; display: inline-block; padding: 2px;">MANUAL ZERO CAL.</div> </div>
(12)		<p>If the operator open the zero gas valve manually, close the valve.</p>	

— How to cancel —

- Press the

ESC

 key to cancel the operation.
- After the cancellation, be sure to close the valves of span gas and zero gas.

7.3 Auto calibration (option)

Description

- Calibration is performed at time intervals set in advance.
- The solenoid valve is driven by contact signal to feed the standard gas for automatic calibration with span gas and zero gas.
- “CAL” is displayed on the left of the measurement screen during automatic calibration.
- If the output signal hold is set, the output signal is held to the set value during calibration. After the calibration, the hold is maintained until the time set in the measurement recovery time elapses.
- For automatic calibration, it is necessary to set “10.2.2 Date and time for starting automatic calibration (option)”, “10.2.3 Cycle time setting of automatic calibration (option)”, “10.2.7 Calibration gas setting”, “10.2.8 Calibration waiting setting (option)”, and “10.5.12 Setting of measurement recovery time (maintenance hold)”.
- Refer to Sections “4.2” and “4.3” for the wiring of solenoid valves.

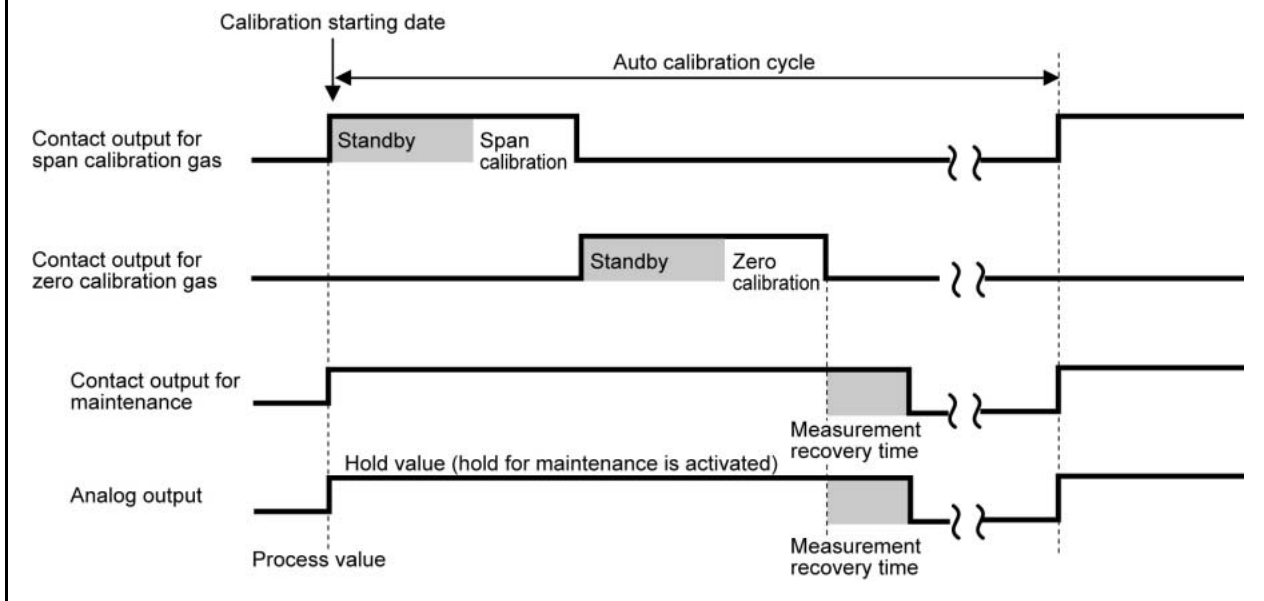

Procedure	Operation (example)	Setting the automatic calibration so that it is performed every four days from 13:00, 2015/02/25	
	Key operation	Description	Displayed message (LCD)
(1)	<input type="button" value="ENT"/>	Display the screen on the right in accordance with the key operation summary and press the <input type="button" value="ENT"/> key.	<div style="border: 1px solid black; padding: 5px; text-align: center;">CALIBRATION MENU SET AUTO CAL</div>
(2)	<input type="button" value="ENT"/>	Press the <input type="button" value="ENT"/> key. The auto calibration valid/invalid setting screen appears.	<div style="border: 1px solid black; padding: 5px; text-align: center;">SET AUTO CAL AUTO CALIBRATION</div>
(3)	<input type="button" value="▶"/> <input type="button" value="ENT"/>	Use the <input type="button" value="▶"/> key to select the auto calibration valid (YES). Press the <input type="button" value="ENT"/> key to set the value.	<div style="border: 1px solid black; padding: 5px; text-align: center;">AUTO CALIBRATION YES NO</div>
(4)	<input type="button" value="ENT"/>	Press the <input type="button" value="ENT"/> key to set the value.	<div style="border: 1px solid black; padding: 5px; text-align: center;">AUTO CALIBRATION YES</div>

(5)		The screen on the right appears.	<div style="border: 1px solid black; padding: 2px; width: fit-content;"> SET AUTO CAL AUTO CALIBRATION </div>
(6)	<div style="border: 1px solid black; padding: 2px; width: fit-content; margin-bottom: 5px;">▲</div> <div style="border: 1px solid black; padding: 2px; width: fit-content;">ENT</div>	Press the ▲ key to display the screen on the right and press the ENT key. The date and time for starting automatic calibration screen appears.	<div style="border: 1px solid black; padding: 2px; width: fit-content;"> SET AUTO CAL START DATE </div>
(7)	<div style="border: 1px solid black; padding: 2px; width: fit-content; margin-bottom: 5px;">▲ ▶</div> <div style="border: 1px solid black; padding: 2px; width: fit-content;">ENT</div>	Use the ▲ and ▶ key to set the auto calibration starting date and time. (Set the date and time of the future.) Press the ENT key to set the value.	<div style="border: 1px solid black; padding: 2px; width: fit-content;"> START DATE 15/02/25 13:00 </div>
(8)	<div style="border: 1px solid black; padding: 2px; width: fit-content;">ENT</div>	Press the ENT key.	<div style="border: 1px solid black; padding: 2px; width: fit-content;"> START DATE 15/02/25 13:00 </div>
(9)		The screen on the right appears.	<div style="border: 1px solid black; padding: 2px; width: fit-content;"> SET AUTO CAL START DATE </div>
(10)	<div style="border: 1px solid black; padding: 2px; width: fit-content; margin-bottom: 5px;">▲</div> <div style="border: 1px solid black; padding: 2px; width: fit-content;">ENT</div>	Press the ▲ key to display the screen on the right and press the ENT key. The cycle time setting of automatic calibration screen appears.	<div style="border: 1px solid black; padding: 2px; width: fit-content;"> SET AUTO CAL AUTO CAL. CYCLE </div>
(11)	<div style="border: 1px solid black; padding: 2px; width: fit-content; margin-bottom: 5px;">▲ ▶</div> <div style="border: 1px solid black; padding: 2px; width: fit-content;">ENT</div>	Use the ▲ and ▶ key to set the auto calibration cycle time. Press the ENT key to set the value.	<div style="border: 1px solid black; padding: 2px; width: fit-content;"> AUTO CAL. CYCLE 04d 00h </div>
(12)	<div style="border: 1px solid black; padding: 2px; width: fit-content;">ENT</div>	Press the ENT key.	<div style="border: 1px solid black; padding: 2px; width: fit-content;"> AUTO CAL. CYCLE 04d 00h </div>
(13)		The display returns to the screen on the right.	<div style="border: 1px solid black; padding: 2px; width: fit-content;"> SET AUTO CAL AUTO CAL. CYCLE </div>

How to cancel

- Press the **ESC** key to cancel the operation.

Note

Automatic calibration is not performed under the following conditions.

- Warm-up is being performed.
- Contact of “Prohibition of calibration” is being input.
- Contact of “Heater off” is being input.

7.4 Remote calibration

This function is available only for the version with auto-calibration.

You can perform all calibration by the contact input of the external terminal block.

To perform remote calibration, install piping and wiring for the standard gas cylinder and the solenoid valve according to Section 4.

- (1) Set one of the contact inputs DI 1 to 3 to “Remote calibration” in accordance with the following operation procedure.
- (2) Close the contact set to the “Remote contact” for one second or more (depending on the settings of (17) to (19) and (20) of the terminal block).
- (3) Remote calibration is started. “RCL” is displayed on the left of the display panel, which disappears when the calibration is completed.

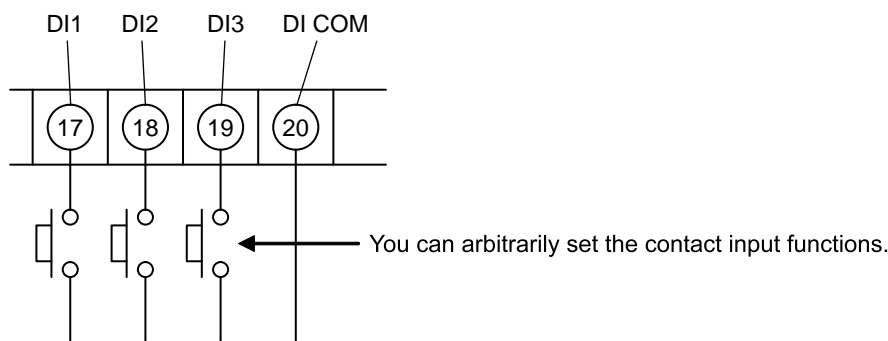







You can arbitrarily set the contact inputs (17), (18), (19) and (20) of the external terminal block (see “10.5.2 Contact input setting”).

Piping and wiring for the standard gas cylinder and the solenoid valve shall be installed.

Description

- You can perform all calibration by the contact input using this function.
- The solenoid valve is driven by contact signal from the terminal block to feed the standard gas for automatic calibration with span gas and zero gas.
- Refer to Sections “4.2” and “4.3” for the wiring of solenoid valves.

Procedure	Operation (example)	Executes remote calibration.	
	Key operation	Description	Displayed message (LCD)
(1)	[ENT]	Display the screen on the right in accordance with the key operation summary and press the [ENT] key. The contact input setting screen appears.	<div style="border: 1px solid black; padding: 2px;">PARAMETER MENU</div> <div style="border: 1px solid black; padding: 2px;">DIGITAL INPUT</div>
(2)	<div style="border: 1px solid black; padding: 2px;">▲</div> <div style="border: 1px solid black; padding: 2px;">[ENT]</div>	Press the ▲ key several times and select one of DI 1 to DI 3. Press the [ENT] key.	<div style="border: 1px solid black; padding: 2px;">DIGITAL INPUT</div> <div style="border: 1px solid black; padding: 2px;">DI *</div>
(3)	[ENT]	Press the [ENT] key. Contact is set.	<div style="border: 1px solid black; padding: 2px;">DI 1</div> <div style="border: 1px solid black; padding: 2px;">NONE</div>
(4)	<div style="border: 1px solid black; padding: 2px;">▲</div> <div style="border: 1px solid black; padding: 2px;">[ENT]</div>	Press the ▲ key several times and select “REMOTE CAL.”. Press the [ENT] key to set the value.	<div style="border: 1px solid black; padding: 2px;">DI 1</div> <div style="border: 1px solid black; padding: 2px;">REMOTE CAL.</div>

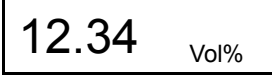
(5)		Press the  key.	
(6)		The screen on the right appears. Press the  key several times and return to the measurement screen.	
(7)		Close the contact set to the “REMOTE CAL.” Remote calibration is performed.	

How to cancel

- Press the  key to cancel the operation.

Note

Automatic calibration is not performed under the following conditions.

- Warm-up is being performed.
- Contact of “Remote blow” is being input.
- Contact of “Prohibition of calibration” is being input.
- Contact of “Heater off” is being input.

7.5 All calibration (option)

Description

- Perform sensor maintenance [sensor check (setting), span and zero calibration once for each sequentially by key operation.
- Actuate the solenoid valve attached to the exterior by the contact signal from the terminal block and supply standard gases sequentially. Span and zero gas calibration are automatically performed.
- If the output signal hold is set, the output signal is held to the set value during calibration. After the calibration, the hold is maintained until the time set in the measurement waiting time elapses.
- To perform sensor maintenance (sensor check) during calibration, “10.4.5 Performing a manual sensor check” are required.
- Refer to Sections “4.2” and “4.3” for the wiring of solenoid valves.

Procedure	Operation (example)	Executes all calibration.	
	Key operation	Description	Displayed message (LCD)
(1)	ENT	Display the screen on the right in accordance with the key operation summary and press the ENT key, the all calibration performing screen appears.	<div style="border: 1px solid black; padding: 5px;"> CALIBRATION MENU ALL CALIBRATION </div>
(2)	ENT	Press the ENT key to perform all calibration.	<div style="border: 1px solid black; padding: 5px;"> ALL CALIBRATION START </div>
(3)		The value of the concentration of oxygen and the cell electromotive force are displayed while executing the all calibration.	<div style="border: 1px solid black; padding: 5px;"> ALL CALIBRATION 20.61 % 000.1 mV </div>
(4)		After the all calibration is completed, the display returns to the screen on the right.	<div style="border: 1px solid black; padding: 5px;"> CALIBRATION MENU ALL CALIBRATION </div>

How to cancel

- Press the ESC key to cancel the operation.

8. BLOWDOWN (OPTION)

In order to prevent the flow guide tube from clogging with dust contained in gas being measured, dust deposits in the flow guide tube is removed by blowing compressed air such as instrumentation air, etc. Use the blowdown function by one of the following three methods.

- (1) Manual blowdown (“8.2”), (2) Automatic blowdown (“8.3”), (3) Remote blowdown (“8.4”)









8.1 Preparation for blowdown

- Wiring/piping check
Perform wiring and piping correctly referring to Item. “4.3”. Since high pressure is applied to the piping, be sure to use blind-nut type joints at connections. Special care should be taken with regard to air-tightness.
- Setting of blowdown time
Referring to “10.3.4 Procedure for setting blowdown time”, set blowdown time.

8.2 Manual blowdown

Description

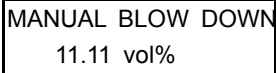
- You can perform blowdown operation once by key operation using this function.

Procedure	Operation (example)	Performing manual blowdown	
	Key operation	Description	Displayed message (LCD)
(1)		Display the screen on the right in accordance with the key operation summary and press the  key, the manual blowdown performing screen enters.	
(2)		Press the  key to perform manual blowdown.	
(3)		While executing, the screen on the right appears.	
(4)		After the calibration is completed, the display returns to the screen on the right.	

How to cancel

- Press the  key to cancel the operation.







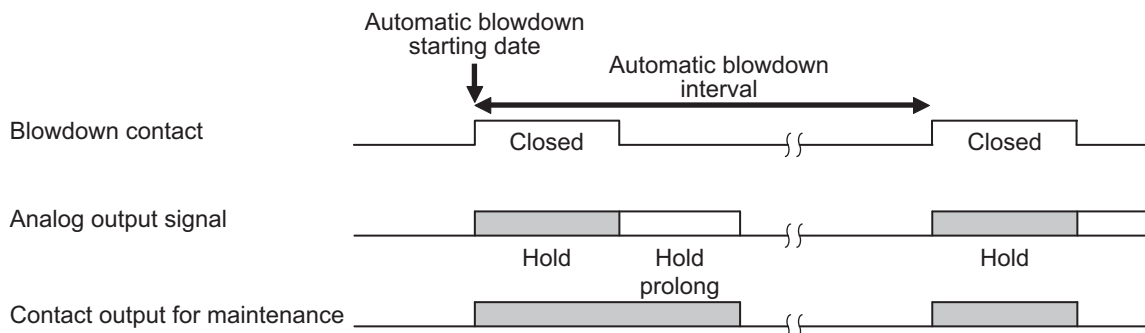

























8.3 Automatic blowdown

Description

- Blowdown operation is performed at time intervals set in advance.
- Using contact signal from the terminal block, drive the solenoid valve and remove dust by blowing instrumentation air, etc. into the flow guide tube with blowdown nozzle.
- “BLW” is displayed on the left of the measurement screen during automatic blowdown.
- If the output signal hold is set, the output signal is held to the set value before start of blowdown during blowdown. After the calibration, the hold is maintained until the time set in the measurement waiting time elapses.
- To perform automatic blowdown, “10.3.2 Date and time setting of automatic blowdown” and “10.3.3 Automatic blowdown cycle setting” and “10.3.4 Procedure for setting blowdown time” are required.



Procedure	Operation (example)	Setting the blowdown so that it is performed for 30 seconds every 24 hours from 13:00, 08/02/25	
	Key operation	Description	Displayed message (LCD)
(1)		Display the screen on the right in accordance with the key operation summary and press the key.	
(2)		Press the key. The auto blowdown valid/invalid setting screen appears.	
(3)	 	Use the key to select the auto blowdown valid (YES). Press the key to set the value.	
(4)		Press the key.	
(5)		The screen on the right appears.	
(6)	 	Press the key to display the screen on the right and press the key. The date and time setting of automatic blowdown screen appears.	

(7)	 	Use the  and  key to set the auto blowdown starting date and time. (Set the date and time of the future.)	<div style="border: 1px solid black; padding: 2px;">START DATE 15/02/25 13:00</div>
		Press the  key to set the value.	
(8)		Press the  key.	<div style="border: 1px solid black; padding: 2px;">START DATE 15/02/25 13:00</div>
(9)		The screen on the right appears.	<div style="border: 1px solid black; padding: 2px;">SET AUTO BLOW START DATE</div>
(10)	 	Press the  key to display the screen on the right and press the  key. The auto setting blowdown interval screen appears.	<div style="border: 1px solid black; padding: 2px;">SET AUTO BLOW AUTO BLOW CYCLE</div>
(11)	  	Use the  and  key to set the auto blowdown interval. Press the  key to set the value.	<div style="border: 1px solid black; padding: 2px;">AUTO BLOW CYCLE 24h 00m</div>
(12)		Press the  key.	<div style="border: 1px solid black; padding: 2px;">AUTO BLOW CYCLE 24h 00m</div>
(13)		The screen on the right appears.	<div style="border: 1px solid black; padding: 2px;">SET AUTO BLOW AUTO BLOW CYCLE</div>
(14)	 	Press the  key to display the screen on the right and press the  key. The setting blowdown time screen appears.	<div style="border: 1px solid black; padding: 2px;">SET AUTO BLOW BLOW DOWN TIME</div>
(15)	  	Use the  and  key to set the blowdown time. (Common with the manual blowdown.) Press the  key to set the value.	<div style="border: 1px solid black; padding: 2px;">BLOW DOWN TIME 030 S</div>
(16)		Press the  key.	<div style="border: 1px solid black; padding: 2px;">BLOW DOWN TIME 030 S</div>
(17)		The display returns to the screen on the right.	<div style="border: 1px solid black; padding: 2px;">SET AUTO BLOW BLOW DOWN TIME</div>

How to cancel

- Press the  key to cancel the operation.

8.4 Remote blowdown

You can perform blowdown by the contact input of the external terminal block.

To perform remote blowdown, install piping and wiring for the supply air and the solenoid valve according to Section 4.

- (1) Set one of the contact inputs DI 1 to 3 to “Blowdown ON” in accordance with the following operation procedure.
- (2) Close the contact set to the “Blowdown ON” for one second or more (depending on the settings of (17) to (19) and (20) of the terminal block).
- (3) Blowdown is started. “RBL” is displayed on the left of the display panel, which disappears when the blowdown is completed. Blowdown continues for the time you set in “10.3.4 Procedure for setting blowdown time”.

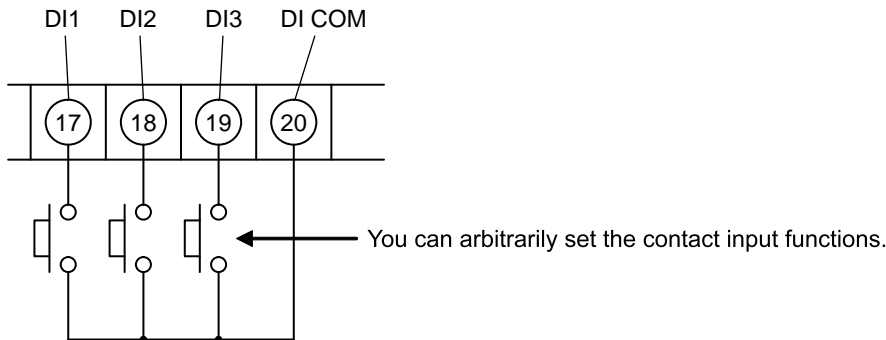







You can arbitrarily set the contact inputs (17) to (19) and (20) of the terminal block (see “10.5.2 Contact input setting”).

Piping and wiring for the supply air and the solenoid valve shall be installed.

Description

- You can perform blowdown by the contact input using this function.
- Actuate the solenoid valve attached to the exterior by the contact signal from the terminal block and flow supply air sequentially. Blowdown is automatically performed.
- Refer to Sections “4.2” and “4.3” for the wiring of solenoid valves.

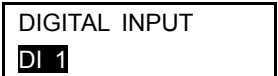
Procedure	Operation (example)	Performing remote blowdown	
	Key operation	Description	Displayed message (LCD)
(1)	[ENT]	Display the screen on the right in accordance with the key operation summary and press the [ENT] key. The contact input setting screen appears.	PARAMETER MENU DIGITAL INPUT
(2)	[▲] [ENT]	Press the [▲] key several times and select one of DI 1 to DI 3. Press the [ENT] key.	DIGITAL INPUT DI 1
(3)	[ENT]	Press the [ENT] key. Contact is set.	DI 1 NONE
(4)	[▲] [ENT]	Press the [▲] key several times and select “BLOW DOWN ON”. Press the [ENT] key to set the value.	DI 1 BLOW DOWN ON

(5)		Press the  key.	
(6)		<p>The screen on the right appears.</p> <p>Press the  key several times and return to the measurement screen.</p>	
(7)		Close the contact set to the “Blowdown ON.” Blowdown is performed.	

How to cancel

- Press the  key to cancel the operation.

9. MAINTENANCE AND CHECK

9.1 Checking

Please regularly check the instrument and carry out maintenance work to use it always in good condition. Check especially the following items. Perform maintenance and check every year or two.

	Items to be checked	Action
Daily inspection	Zero and span calibration	Perform calibration every week.
	Calibration gas pressure	Replace calibration gas cylinder when the primary pressure becomes around 1 MPa.
	Check for loose cable gland	Check if the screw is tightened. If the screw is loose, tighten it.
Periodic inspection	Case packing	If there are any cracks on the surface of packing, replace it with new one.
	Key sheet	If damaged, replace it with new one.
	Packing of cable gland	If there is any cracks in the packings inside cable glands, replace the packing with new one. Pay attention to the exposed surface of packing if there are any cracks.

9.2 Spare parts

No.	Name	Part number	Q'ty	Remarks
1	LCD module assembly	*ZZPZKM2—TK4K9805C1	1 set	Includes LCD
2	I/O board	*ZZPZKM2—TQ502655C1	1 set	Includes electrolytic capacitor. To order this part, type code written on the specification nameplate is required.
3-1	Case packing	*ZZPZKM2—TK4K9807P3	1	For ZKMA
3-2	Case packing	*ZZPZKM2—TK7H7465P1	1	For ZKMB
4	Key sheet	*ZZPZKM2—TQ402693P1	1	
5	Packing	*ZZPZKM2—TQ502593P3	1 set	For the cable gland used to connect the detector.
6-1	Packing	*ZZPZKM2—TK7M6120P1	2	Small packing for the cable gland (optional) for ZKMA
6-2	Packing	*ZZPZKM2—TK7M6120P2	2	Large packing for the cable gland (optional) for ZKMA
7	O-rings	*ZZPZKM2—TK4K9799P13	4	These are the parts used for the case fixing screw for ZKMB.

Note 1: With regard to No.1 and No.2, refer to "Warranty and maintenance" in this instruction manual.

Note 2: Consult us for the replacement. Disassembly may result in an electric shock or personal injury.

9.3 Replacement of fuse

If a fuse blows, turn off the power, and replace the fuse after investigating the cause.

Open the front door and you can see the a fuse on the case.

To replace the fuse, insert a flathead screwdriver or coin into the fuse cap and turn it to the left while pressing it in order to remove the cap and replace the fuse.

Put the cap on the fuse and turn it to the right to fix it.

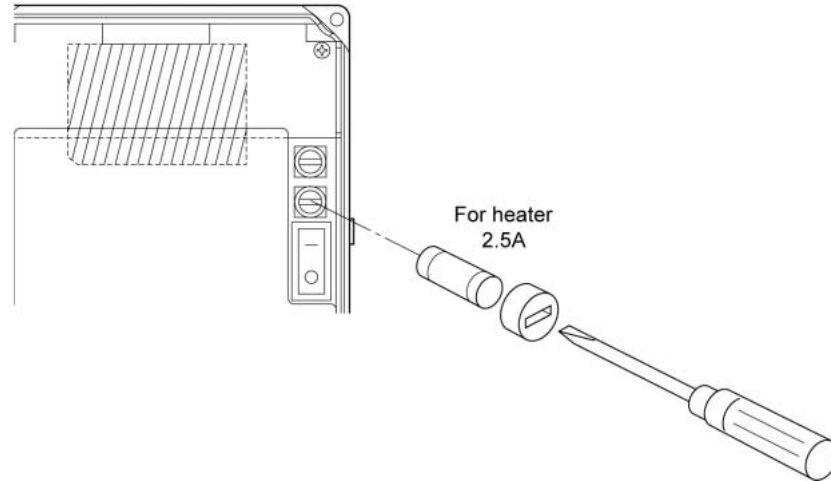

For heater: $\varnothing 5 \times 20$ mm 2.5 A (Example: 0213, 2.5 A, manufactured by Littelfuse)

Note: Use time-lag fuses.

9.4 Adjustment of monitor contrast

You can adjust the monitor contrast to improve the readability.



ZKMA

Open the cover, and you can see the volume knob (VR1) on the CPU board. Turn the knob with a flathead screwdriver to adjust the contrast.



ZKMB

Open the front cover and the inner cover, and you can see the volume knob (VR1) on the CPU board. Turn the knob with a flat-head screwdriver to adjust the contrast.

9.5 Troubleshooting

Phenomena	Probable causes	Checking methods (normal value)	Remedy
No display	Converter fuse blown out	Check the fuse and supply voltage specification.	Replace fuse Check Power supply voltage
Indication does not change or slow response	Filter and/or flow guide tube clogged	Visual check of filter and flow guide tube for contamination or clogging. Check for loosen and gas leaks at piping connections and mounting place of detector.	Clean or replace filter Tighten pipe connections
	Sensor deterioration	Change over between zero and span gas and check if 5 minutes or longer is needed for 90% response.	Replace sensor
	Decrease in flow velocity of exhaust gas	Check response to process gas after shutting down calibration gas. Move the direction (mounting position) of "arrow" of the flow guide slightly.	Increase process gas Flow into the flow guide tube.
Temperature alarm continues for more than 10 min. after power switched ON	Break of wiring Wrong wiring Source voltage is too low.	Cable check of wiring Wiring check Check of supply voltage specification	Replacement Correct wiring Check power supply
	Break of thermocouples	Break check	Replace sensor
	Blown heater fuse	Cable check of fuse	Replace fuse
	Break in detector heater	Check heater resistance 50 to 55Ω for 115V, 200 to 250Ω for 220V (Excluding wiring resistance)	Replace sensor
Automatic calibration is not possible	Difference between calibration gas concentration and its setting	Check the set value for calibration gas concentration.	Set proper value (Refer to "10.2.7")
	Wrong parameters setting	Check automatic calibration intervals.	<ul style="list-style-type: none"> Set proper parameters
	The calibration is prohibited in the contact input of the external terminal block.	Check if the calibration is not prohibited in the contact input of the external terminal block.	<ul style="list-style-type: none"> Set proper parameters Correct wiring
	The heater is set to off at the contact input of the external terminal block.	Check if the heater is set to off at the contact input of the external terminal block.	<ul style="list-style-type: none"> Set proper parameters Correct wiring
Zero and/or span alarm	Difference between calibration gas concentration and its setting or misconnection between zero and span gas	Check the set value for calibration gas concentration.	<ul style="list-style-type: none"> Set proper value
		Check piping.	<ul style="list-style-type: none"> Correct wiring
Indication too high or too low	Loose flange and its surroundings Deteriorated O-rings	Check for gas leaks in detector and mounting part of flow guide tube flange.	<ul style="list-style-type: none"> Tighten mounting screws Replace sensor
		Check for leaks from the outside.	<ul style="list-style-type: none"> Seal
	Detector is faulty.	Check for gas leaks at calibration gas inlet. Check sensor voltage (mV) for higher or lower than other detector when flowing zero gas. (See "6.5 Oxygen detector standard output voltage")	<ul style="list-style-type: none"> Tighten connectors Replace sensor
	Abnormal detector temperature	Refer to check items for detector temperature alarm described above.	<ul style="list-style-type: none"> Replace sensor
	Indication difference between dry and wet base measurement	Oxygen concentration is higher in dry base.	<ul style="list-style-type: none"> Normal
Unstable readings	The power supply voltage is too high or too low.	Check that the supplied voltage is as specified.	<ul style="list-style-type: none"> Auto-tuning

Phenomena	Probable causes	Checking methods (normal value)	Remedy
Disconnection detection error	Break of thermocouples Break of sensor Wrong wiring	Cable check of wiring Wiring check	<ul style="list-style-type: none"> • Replace the defective parts. • Correct wiring • Turn on/off the power supply.
Range cannot be switched.	“Range setting” is set in the contact input setting.	Check if “Range setting” is set in the contact input setting.	Cancel “Range setting” in the contact input setting.













10. SETTING AND OPERATING OF PARAMETER

10.1 Measured menu

10.1.1 Display range setting screen

Description

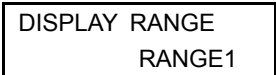
- You can set the display range of oxygen concentration value using this function.
- Settable range: Select one of the following
 - “Range 1”: Displayed in the range set in the range setting 1.
 - “Range 2”: Displayed in the range set in the range setting 2.

Procedure	Operation (example)	Setting the display range to “Range 1”	
	Key operation	Description	Displayed message (LCD)
(1)		Display the screen on the right in accordance with the key operation summary and press the  key. The display range setting screen appears.	
(2)	 	Use the  key to select the range-1. Press the  key to set the value.	
(3)		Press the  key.	
(4)		When it is fixed, the display returns to the screen on the right.	















Note

- If “Range setting” is set in the contact input setting, you cannot change the display range on this screen.

10.1.2 Decimal point position setting screen

Description

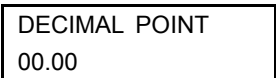
- You can set the decimal point position of full scale for oxygen concentration display using this function.
- Settable range: Select one of the following.
 - “00.00”: Displayed with two-digit integer and two decimal places.
 - “0.000”: Displayed with one-digit integer and three decimal places.

Procedure	Operation (example)	Setting the display of two-digit integer and two decimal places (Range 1)	
	Key operation	Description	Displayed message (LCD)
(1)		Display the screen on the right in accordance with the key operation summary and press the  key.	
(2)		Press the  key. The decimal point position setting screen appears.	
(3)	 	Use the  key to select the two-digit integer and two decimal places. Press the  key to set the value.	
(4)		Press the  key.	
(5)		When it is fixed, the display returns to the screen on the right.	



















Note

- If changing “0.000” to “00.00,” “25.00” is set as the full scale value.
- If changing “00.00” to “0.000,” “5.000” is set as the full scale value.

10.1.3 Full scale setting screen

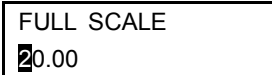
Description

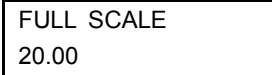











- You can set the full scale value for display of oxygen concentration value using this function.
- Settable range: If the decimal point position is set to "00.00": 02.00 to 50.00 vol%
If the decimal point position is set to "0.000": 2.000 to 9.000 vol%

Procedure	Operation (example)	Setting the full scale value to 20.00% (Range-1)	
	Key operation	Description	Displayed message (LCD)
(1)		Display the screen on the right in accordance with the key operation summary and press the  key.	
(2)	 	Press the  key to display the screen on the right and press the  key. The full scale setting screen appears.	
(3)	  	Use the  and  key to set the full scale value. Press the  key to set the value.	
(4)		Press the  key.	
(5)		The display returns to the screen on the right.	

10.1.4 Setting screen for calculation time of maximum and minimum values appears

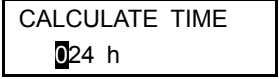
Description

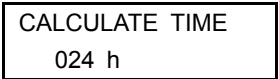
- You can set the calculation time of maximum and minimum values of oxygen concentration value using this function.
- Settable range: 0 to 240h















Procedure	Operation (example)	Setting the calculation time of maximum and minimum values to 24 hours	
	Key operation	Description	Displayed message (LCD)
(1)		Display the screen on the right in accordance with the key operation summary and press the  key. The setting screen for calculation time of maximum and minimum values appears.	
(2)	  	Use the  and  key to set the calculation time of maximum and minimum values. Press the  key to set the value.	
(3)		Press the  key.	
(4)		When it is fixed, the display returns to the screen on the right.	

10.2 Calibration menu

10.2.1 Automatic calibration setting (option)

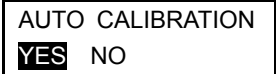
Description

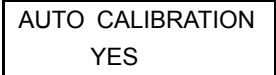
- You can set the automatic calibration to valid or invalid using this function.
- If changing the automatic calibration setting from valid to invalid during automatic calibration or remote calibration, the calibration is forcibly canceled.

Procedure	Operation (example)	Setting the automatic calibration to valid	
	Key operation	Description	Displayed message (LCD)
(1)		Display the screen on the right in accordance with the key operation summary and press the  key.	
(2)		Press the  key. The auto calibration valid/invalid setting screen appears.	
(3)	 	Use the  key to select the auto calibration valid (YES). Press the  key to set the value.	
(4)		Press the  key.	
(5)		The display returns to the screen on the right.	

Note

- If the time for automatic calibration comes during manual treatments (calibration, blowdown, or sensor check) or remote treatments (calibration, blowdown, or heater off), the treatment being performed is prioritized and the automatic calibration starts after the treatment is completed.
- If the time for automatic calibration comes at the same time with automatic blowdown, the automatic blowdown starts first and the automatic calibration starts after the automatic blowdown is completed.
- If “Prohibition of calibration” is set in the contact input setting and the contact input is on, automatic calibration is not performed.
- If disconnection is detected (O₂ sensor input, O₂ sensor thermocouple input, or thermocouple input (combustion control: option)), or a heater temperature error or A/D saturation error occurs, automatic calibration is not performed.
- Automatic calibration is not available during warm-up operation.

10.2.2 Date and time for starting automatic calibration (option)

Description

- You can set the date and time for starting automatic calibration using this function. Automatic calibration is performed in a specified cycle from a specified date and time.
- If it is invalid, the automatic calibration does not start at a specified date and time.
- Settable range: date and time in the future in the calendar

Procedure	Operation (example)	Setting the automatic calibration so that it is performed from 13:00, 2015/02/25	
	Key operation	Description	Displayed message (LCD)
(1)		Display the screen on the right in accordance with the key operation summary and press the key.	
(2)	 	Press the key to display the screen on the right and press the key. The auto calibration starting date and time setting screen appears.	
(3)	 	Use the and key to set the auto calibration starting date and time. Press the key to set the value.	
(4)		Press the key.	
(5)		The display returns to the screen on the right.	

Note

- You cannot change the setting value during automatic calibration or remote calibration.
- Check that “Current date and time setting” in the parameter menu is properly set.

10.2.3 Cycle time setting of automatic calibration (option)

Description

- You can set the automatic calibration cycle using this function.
The cycle starts from a specified date and time for automatic calibration.
- Settable range: 00d 00h to 99d 23h (h: 00 to 23)

Procedure	Operation (example)	Setting the automatic calibration so that it is performed every four days	
	Key operation	Description	Displayed message (LCD)
(1)		Display the screen on the right in accordance with the key operation summary and press the key.	
(2)	 	Press the key to display the screen on the right and press the key. The cycle time setting of automatic calibration appears.	
(3)	 	Use the and key to set the auto calibration starting date and time. Press the key to set the value.	
(4)		Press the key.	
(5)		The display returns to the screen on the right.	









Note

- You cannot change the setting value during automatic calibration or remote calibration.

10.2.4 Performing all calibration (option)

Description

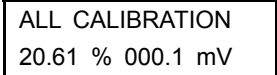
- You can perform all calibration on the screen using this function.
Zero calibration is automatically performed after the span calibration.
- You cannot perform “All calibration” during warming-up operation.

Procedure	Operation (example)	Performing all calibration on the screen	
	Key operation	Description	Displayed message (LCD)
(1)		Display the screen on the right in accordance with the key operation summary and press the  key, the all calibration performing screen appears.	
(2)		Press the  key to perform all calibration.	
(3)		Oxygen concentration value and cell electromotive force are displayed during all calibration.	
(4)		After the all calibration is completed, the display returns to the screen on the right.	











How to cancel

- Press the  key to cancel the operation.

10.2.5 Performing a manual span calibration

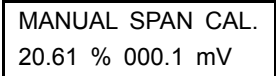
Description

- Before starting span calibration, the operator shall supply span gas to the detector and check that the display is stabilized.
- You cannot perform manual span calibration during warming-up operation.

Procedure	Operation (example)	Performing span calibration on the screen	
	Key operation	Description	Displayed message (LCD)
(1)		Display the screen on the right in accordance with the key operation summary and press the  key, the manual span calibration screen appears.	
(2)		Press the  key to perform manual span calibration. If supplying calibration gas manually (without the auto-calibration function) The operator shall open the span gas valve manually and adjust the flow rate to 1.5 ± 0.5 L/min.	
(3)		If your detector has the auto-calibration function, you can activate the external solenoid valve using the contact output signal at the terminal block. Oxygen concentration value and cell electromotive force are displayed. Wait until the oxygen concentration is stabilized.	
(4)		Press the  key to determine the span calibration factor. During the process, the oxygen concentration value and cell electromotive force are highlighted.	
(5)		After the calibration is completed, the display returns to the screen on the right.	
(6)		If the operator opened the span gas valve manually, close the valve.	











How to cancel

- Press the  key to cancel the operation.
- After the cancellation, be sure to close the valves of span gas.

10.2.6 Performing a manual zero calibration

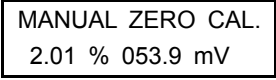
Description

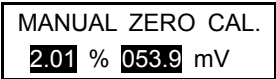
- Before starting zero calibration, the operator shall supply zero gas to the detector and check that the display is stabilized.
- You cannot perform manual zero calibration during warming-up operation.

Procedure	Operation (example)	Performing zero calibration on the screen	
	Key operation	Description	Displayed message (LCD)
(1)		Display the screen on the right in accordance with the key operation summary and press the  key, the manual zero calibration screen appears.	
(2)		Press the  key to perform manual zero calibration. If supplying calibration gas manually (without the auto-calibration function) The operator shall open the zero gas valve manually and adjust the flow rate to 1.5 ± 0.5 L/min.	
(3)		If your detector has the auto-calibration function, you can activate the external solenoid valve using the contact output signal at the terminal block. Oxygen concentration value and cell electromotive force are displayed. Wait until the oxygen concentration is stabilized.	
(4)		Press the  key to determine the zero calibration factor. During the process, the oxygen concentration value and cell electromotive force are highlighted.	
(5)		After the calibration is completed, the display returns to the screen on the right.	
(6)		The operator shall close the zero gas valve manually.	











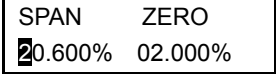

How to cancel

- Press the  key to cancel the operation.
- After the cancellation, be sure to close the valves of zero gas.

10.2.7 Calibration gas setting

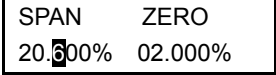
Description

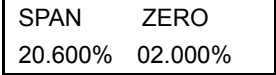
- Set calibration gas concentration (span/zero calibration gas concentrations).
Use the calibration gas concentration 1 for the range 1, and the calibration gas concentration 2 for the range 2.
- Use normal air (atmosphere) as a span calibration gas and set its concentration to 20.600% O₂/N₂.
- Settable range: Span calibration gas 00.010 to 50.000 %O₂/N₂
Zero calibration gas 00.010 to 25.000 %O₂/N₂

Procedure	Operation (example)	Setting the span/zero calibration gas concentrations (Range 1)	
	Key operation	Description	Displayed message (LCD)
(1)		Display the screen on the right in accordance with the key operation summary and press the  key.	
(2)		The set content is displayed now.	
(3)	  	Use the  and  key to change the calibration gas concentrations. Press the  key to set the value.	
(4)		The set content is displayed. Press the  key.	
(5)		The display returns to the screen on the right.	













Note

- You cannot change the setting value during automatic calibration or remote calibration.
- Set with span calibration gas concentrations \geq zero calibration gas concentrations.

10.2.8 Calibration waiting setting (option)

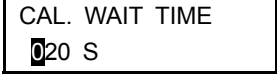
Description

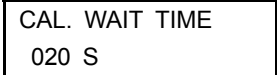
- Set the waiting time from supply of calibration gas to start of calibration.
(Set the time so that the calibration gas becomes stable before the calibration.)
- Settable range: 10 to 999sec.

Procedure	Operation (example)	Setting the waiting time before the start of calibration to 20 seconds	
	Key operation	Description	Displayed message (LCD)
(1)		Display the screen on the right in accordance with the key operation summary and press the  key.	
(2)	  	The currently set content is displayed. Use the  and  key to change the wait time. Press the  key to set the value.	
(3)		Press the  key.	
(4)		The display returns to the screen on the right.	











Note

- You cannot change the setting value during automatic calibration or remote calibration.

10.2.9 Calibration error clear

Description











- You can clear the errors occurred during calibration using this function.
If an error occurs during calibration, an error display (Er4, Er5) and abnormal contact output (close) continues until the next calibration is properly completed.
- Clear the error display on the measurement screen and open the abnormal contact output.
- Error log information is not cleared.

Procedure	Operation (example)	Clearing a calibration error	
	Key operation	Description	Displayed message (LCD)
(1)		Display the screen on the right in accordance with the key operation summary and press the  key. The calibration error clear screen appears.	
(2)		Press the  key. (The calibration error is not cleared yet.)	
(3)		Press the  key. (Calibration error cleared.)	
(4)		The display returns to the screen on the right.	

10.2.10 Operation setting screen of calibration range

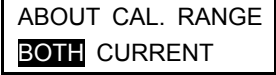
Description

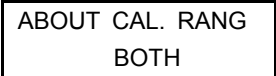
- During calibration, you can select single or common range for the calibration factor using this function.
- Settable range: Select one of the following.
 - (1) “Range interlock”: Performs calibration of the range that is currently displayed and sets the calibration factors of the other ranges to the same value as above.
 - (2) “Display range”: Performs calibration of the range that is currently displayed.















Procedure	Operation (example)	Setting the calibration range to range interlock	
	Key operation	Description	Displayed message (LCD)
(1)		Display the screen on the right in accordance with the key operation summary and press the  key. The operation setting screen of calibration range appears.	
(2)	 	Use the  key to select the range interlock. Press the  key to set the value.	
(3)		Press the  key.	
(4)		When it is fixed, the display returns to the screen on the right.	

10.3 Blowdown menu (option)

10.3.1 Automatic blowdown setting

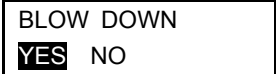
Description

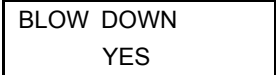
- You can set the automatic blowdown to valid or invalid using this function.
- If changing the automatic blowdown setting from valid to invalid during automatic blowdown, the blowdown is forcibly canceled.

Procedure	Operation (example)	Setting the automatic blowdown to valid	
	Key operation	Description	Displayed message (LCD)
(1)		Display the screen on the right in accordance with the key operation summary and press the  key.	
(2)		Press the  key. The auto blowdown valid/invalid setting screen appears.	
(3)	 	Use the  key to select the auto blowdown valid (YES). Press the  key to set the value.	
(4)		Press the  key.	
(5)		The display returns to the screen on the right.	

















Note

- If the time for automatic calibration comes during manual treatments (calibration, blowdown, sensor check) or remote treatments (calibration, blowdown, or heater off), the treatment being performed is prioritized and the automatic calibration starts after the treatment is completed.
- If the time for automatic blowdown comes at the same time with automatic calibration, the automatic blowdown starts first.
- If disconnection is detected (O₂ sensor input, O₂ sensor thermocouple input, or thermocouple input (combustion control: option)), or heater temperature error or A/D saturation error occurs, automatic calibration is not performed.

10.3.2 Date and time setting of automatic blowdown

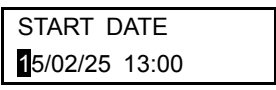
Description

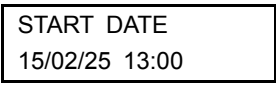
- You can set the date and time for starting automatic blowdown using this function. Automatic blowdown is performed in a specified cycle from a specified date and time.
- If it is invalid, automatic blowdown does not start at a specified date and time.
- Settable range: date and time in the future in the calendar

Procedure	Operation (example)	Setting the date and time for starting automatic blowdown to 13:00, 2015/02/25	
	Key operation	Description	Displayed message (LCD)
(1)		Display the screen on the right in accordance with the key operation summary and press the  key.	
(2)		Press the  key. The date and time setting of automatic blowdown screen appears.	
(3)	  	Use the  and  key to set the automatic blowdown starting date and time screen. Press the  key to set the value.	
(4)		Press the  key.	
(5)		The display returns to the screen on the right.	

Note

- You cannot change the setting value during automatic blowdown or remote blowdown.
- Check that “Current date and time setting” in the parameter menu is properly set.

10.3.3 Automatic blowdown cycle setting

Description

- You can set the automatic blowdown cycle using this function.
The cycle starts from a specified date and time for automatic blowdown.
- Settable range: 00h 00m to 99h 59m (m: 00 to 59)

Procedure	Operation (example)	Setting automatic blowdown cycle to 24 hours.	
	Key operation	Description	Displayed message (LCD)
(1)		Display the screen on the right in accordance with the key operation summary and press the key.	
(2)	 	Press the key to display the screen on the right and press the key. The auto blowdown cycle setting screen appears.	
(3)	 	Use the and key to select the auto blowdown cycle. Press the key to set the value.	
(4)		Press the key.	
(5)		The display returns to the screen on the right.	

Note

- You cannot change the setting value during automatic blowdown or remote blowdown.
- Set the blowdown cycle value larger than the blowdown time.

10.3.4 Procedure for setting blowdown time

Description

- You can set the blowdown time using this function (common with manual blow down).
- Settable range: 0 to 999 sec.

Procedure	Operation (example)	Setting blowdown time to 30 seconds.	
	Key operation	Description	Displayed message (LCD)
(1)		Display the screen on the right in accordance with the key operation summary and press the key.	
(2)	 	Press the key to display the screen on the right and press the key. The procedure for setting blowdown time screen appears.	
(3)	 	Use the and key to set the blowdown time. Press the key to set the value.	
(4)		Press the key.	
(5)		The display returns to the screen on the right.	









Note

- You cannot change the setting value during automatic blowdown or remote blowdown.
- Set the blowdown cycle value smaller than the blowdown time.

10.3.5 Performing manual blowdown

Description

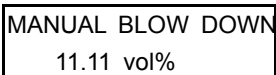
- You can perform blowdown on the screen using this function.
- If you perform remote control (calibration, blowdown, turning off the heater) during manual blowdown, remote control is prioritized and manual blowdown is stopped.

Procedure	Operation (example)	Performing blowdown on the screen	
	Key operation	Description	Displayed message (LCD)
(1)		Display the screen on the right in accordance with the key operation summary and press the  key, the manual blowdown performing screen appears.	
(2)		Press the  key to perform manual blowdown.	
(3)		Oxygen concentration value is displayed during manual blowdown.	
(4)		After the calibration is completed, the display returns to the screen on the right.	

How to cancel













- Press the  key to cancel the operation.

10.4 Maintenance menu

10.4.1 Error log display

Description

- You can display an error log on the screen using this function.
- A latest piece of error information is displayed first.
The maximum of 12 pieces of error information are saved.
Press the  key to display the older pieces of error information.
The latest piece of error information is displayed next to the oldest piece of error information.
- The oldest piece of error information is overwritten by a new one.

Procedure	Operation (example)	Displaying an error log on the screen	
	Key operation	Description	Displayed message (LCD)
(1)		Display the screen on the right in accordance with the key operation summary and press the  key.	<div style="border: 1px solid black; padding: 5px; width: fit-content;"> MAINTE MENU ERROR LOG </div>
(2)		Use the  key to select the error log screen.	<div style="border: 1px solid black; padding: 5px; width: fit-content;"> ERROR LOG DISP CLEAR </div>
(3)		Press the  key, the latest error log appears.	<div style="border: 1px solid black; padding: 5px; width: fit-content;"> YY/MM/DD HH:MM ***** </div>
(4)		Press the  key to display the previous piece of error log information.	<div style="border: 1px solid black; padding: 5px; width: fit-content;"> YY/MM/DD HH:MM ***** </div>
(5)		Press the  key, the display returns to the screen on the right.	<div style="border: 1px solid black; padding: 5px; width: fit-content;"> ERROR LOG DISP CLEAR </div>
(6)		Press the  key again to return to the screen on the right.	<div style="border: 1px solid black; padding: 5px; width: fit-content;"> MAINTE MENU ERROR LOG </div>















Error logs

Display message	Status
Sensorline Error	Sensor line disconnection of the zirconia oxygen sensor was detected.
TC-line Error	Temperature control line disconnection of the zirconia oxygen sensor was detected.
Sub temp. Error	Line disconnection of the thermocouple for combustion control was detected.
Warm-up Error	Warm-up was not completed within the warm-up monitoring time (45 minutes). <ul style="list-style-type: none"> Warm-up is properly completed if the heater temperature of the zirconia oxygen sensor becomes the control temperature ($800^{\circ}\text{C} \pm 1^{\circ}\text{C}$) and stable for one minute.
Cell temp. Error	Heater temperature exceeds the specified range ($800^{\circ}\text{C} \pm 70^{\circ}\text{C}$)
Span gas Error	<ul style="list-style-type: none"> The concentration of the calibration span gas being supplied is not stable. (In a discrimination treatment of stability, the error of $\pm 0.2\%$ or more compared to the value in the previous treatment continues.)
Zero gas Error	<ul style="list-style-type: none"> The concentration of the calibration zero gas being supplied is not stable. (In a discrimination treatment of stability, the error of $\pm 0.2\%$ or more compared to the value in the previous treatment continues.)
Span cal. Error	Span calibration failed. (Calibration factor could not be determined.)
Zero cal. Error	Zero calibration failed. (Calibration factor could not be determined.)
Sensor Error, A/D data Error	An error was detected in the A/D conversion of oxygen concentration value of the zirconia oxygen sensor. (260 mV or more, -50 mV or less)

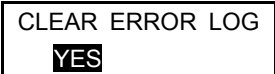
10.4.2 Clearing error logs

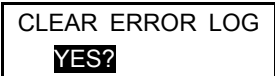
Description













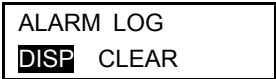

- You can clear all error logs saved using this function.

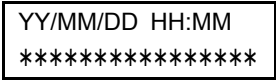
Procedure	Operation (example)	Clearing all error logs saved	
	Key operation	Description	Displayed message (LCD)
(1)		Display the screen on the right in accordance with the key operation summary and press the  key.	
(2)		Use the  key to select the error log clear screen.	
(3)		Press the  key to clearing error logs. (However, it has not been deleted yet.)	
(4)		The screen is displayed again to check. Press the  key to clear all the error logs.	
(5)		After the processing is completed, the display changes to the menu screen.	
(6)		Press the  key again to return to the screen on the right.	

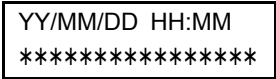
10.4.3 Alarm log display

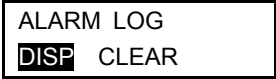
Description

- You can display alarm logs on the screen using this function.
- A latest piece of alarm information is displayed first.
The maximum of 12 pieces of alarm information are saved.
Press the  key to display the older pieces of alarm information.
The latest piece of alarm information is displayed next to the oldest piece of alarm information.
- The oldest piece of alarm information is overwritten by a new one.

Procedure	Operation (example)	Displaying alarm logs on the screen	
	Key operation	Description	Displayed message (LCD)
(1)		Display the screen on the right in accordance with the key operation summary and press the  key.	
(2)		Use the  key to select the alarm log display screen.	
(3)		Press the  key, the latest alarm log appears.	
(4)		Press the  key to display the previous piece of alarm log information.	
(5)		Press the  key, the display returns to the screen on the right.	
(6)		Press the  key again to return to the screen on the right.	











Alarm logs

Display message	Status
High alarm	Oxygen concentration value exceeded a specified upper limit.
Low alarm	Oxygen concentration value exceeded a specified lower limit.
Hi-High alarm	Oxygen concentration value exceeded a specified Hi-High limit.
Low-Low alarm	Oxygen concentration value exceeded a specified Low-Low limit.

10.4.4 Clearing alarm logs

Description









- You can clear all alarm logs using this function.

Procedure	Operation (example)	Clearing all alarm logs saved	
	Key operation	Description	Displayed message (LCD)
(1)		Display the screen on the right in accordance with the key operation summary and press the  key.	<div style="border: 1px solid black; padding: 5px;"> MAINTE MENU ALARM LOG </div>
(2)		Use the  key to select the alarm log clear screen.	<div style="border: 1px solid black; padding: 5px;"> ALARM LOG DISP CLEAR </div>
(3)		Press the  key to perform clearing alarm logs. (However, it has not been deleted yet.)	<div style="border: 1px solid black; padding: 5px;"> CLEAR ALARM LOG YES </div>
(4)		The screen is displayed again to check. Press the  key to clear all the alarm logs.	<div style="border: 1px solid black; padding: 5px;"> CLEAR ALARM LOG YES? </div>
(5)		After the processing is completed, the display changes to the menu screen.	<div style="border: 1px solid black; padding: 5px;"> ALARM LOG DISP CLEAR </div>
(6)		Press the  key again to return to the screen on the right.	<div style="border: 1px solid black; padding: 5px;"> MAINTE MENU ALARM LOG </div>

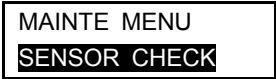
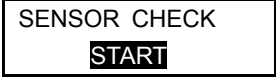
10.4.5 Performing a manual sensor check

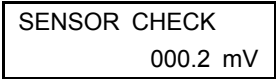
Description

- Manually supply atmospheric air or air from cylinder to the detector in order to measure the electromotive force of the sensor.

Proce- dure	Operation (example)	Performing a sensor check on the screen	
	Key operation	Description	Displayed message
(1)		Display the screen on the right in accordance with the key operation summary and press the  key, the manual sensor check performing screen appears.	
(2)		Supplying atmospheric air or air from cylinder manually (1.5 ± 0.5 L/min).	
(3)		Press the  key to perform sensor check. During the process, electromotive force of the sensor is displayed.	
(4)		Press the  key to return to the screen on the right.	
(5)		When the check is completed, manually stop supplying air to the detector.	











Note

- If the electromotive force of the sensor is out of the range from -5.0 mV through +5.0 mV, it is recommended to replace the sensor.

10.4.6 Maintenance mode setting

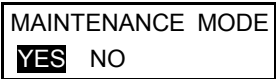
Description

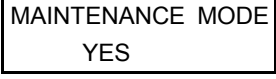
- You can set the maintenance mode to valid or invalid with this function.
- If the maintenance mode is set to valid, the analog output signal is held at the set value (see “10.5.10 Hold value setting.”) and the contact output for maintenance of the external contact is on. The data portion of the measurement screen flickers.

Procedure	Operation (example)	Setting the maintenance mode to valid	
	Key operation	Description	Displayed message (LCD)
(1)		Display the screen on the right in accordance with the key operation summary and press the  key, the maintenance mode setting screen appears.	
(2)	 	Use the  key to select the maintenance mode valid (YES). Press the  key to set the value.	
(3)		Press the  key.	
(4)		The display returns to the screen on the right.	

















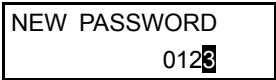

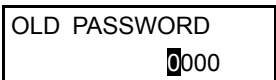
Note

- If an error occurs while the maintenance mode is enabled, error handling is prioritized.
- If the analog output hold function (error hold) is enabled, the analog output signal is held at the value set at the hold value setting (error hold).
- The data portion of the measurement screen flickers and is highlighted.

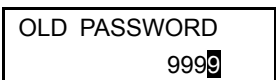
10.4.7 Password setting

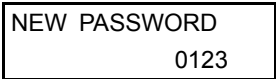
Description









- You can set a password for switching the “Key lock function” valid /invalid, which is to prevent unauthorized people from making various setting or operating the unit manually (modification, etc.)
Note: Refer to “Setting of key lock” Paragraph (“10.5.16”).
- When you set the “new password” you desire, the screen transits to the password authentication screen automatically.
After you input the “old password” in the password authentication screen, the new password will be registered.
- The factory-set password is “0000”.
An authorized person should manage the set password for remembrance’ sake.
- Settable value: 4 digits from 0 to 9

Procedure	Operation (example)	Setting to change from old password “9999” to new password “0000”	
	Key operation	Description	Displayed message (LCD)
(1)		Display the screen on the right in accordance with the key operation summary and press the  key.	
(2)	 	Use the  key and the  key to input the new password.	
(3)		Press the  key.	
(4)	 	Use the  key and the  key to input the old password.	
(5)		The new password is displayed by pressing the  key.	
(6)		Press the  key to go back to the screen on the right.	

10.4.8 PID auto tuning

Description

- Heater temperature of the detector is PID controlled. This "PID auto-tuning" function optimizes each value of P (proportion), I (integration) and D (derivation) for the environment where the unit is installed.
Note: Each value of P, I, and D has been set at factory. If temperature is not properly controlled, perform PID auto tuning.
- Measured value and analog output become unstable during PID auto tuning because the controlled temperature goes up and down.
- You can hold the analog output value during PID auto tuning, because it is a part of maintenance (Refer to 10.5.9 "Hold treatment setting (maintenance hold)").
- You cannot use PID auto tuning with auto calibration or automatic blowdown at the same time.

Procedure	Operation (example)	Execute PID auto tuning from the screen	
	Key operation	Description	Displayed message (LCD)
(1)		Display the screen on the right in accordance with the key operation summary and press the  key to display the PID AUTO TUNING START screen.	
(2)		Press the  key to start PID auto tuning.	
(3)		Temperature to be displayed changes during PID auto tuning.	
(4)		When PID auto tuning is finished automatically, the display returns to the screen on the right.	

How to cancel









- Press the  key to cancel PID auto tuning.
If you cancel PID auto tuning, each value of P, I and D is to be the value before tuning.

10.5 Parameter menu

10.5.1 Current date and time setting

Description

- You can set a current date and time for the unit using this function.
- Settable range: date and time in the future in the calendar

Procedure	Operation (example)	Setting the current date and time to 13:00, 2015/02/25	
	Key operation	Description	Displayed message (LCD)
(1)		Display the screen on the right in accordance with the key operation summary and press the  key.	PARAMETER MENU DATE SET
(2)	  	Use the  and  key to set the date and time. Press the  key to set the value.	DATE SET 15/02/25 13:00
(3)		The display returns to the screen on the right.	PARAMETER MENU DATE SET

10.5.2 Contact input setting

Description

- You can set the functions for the contact inputs 1 to 3 using this function.
- Settable range: Select one of the following
 - (1) [NONE] : Performs no treatment by contact input.
 - (2) [BLOW DOWN ON] : Performs blowdown by contact input.
(Switch OFF to ON to perform blowdown.)
 - (3) [HEATER OFF] : Turn off the heater by contact input.
(OFF/ON: Heater ON/Heater OFF)
 - (4) [PROHIBIT CAL.] : Sets if calibration is prohibited or valid by contact input.
(OFF/ON: Calibration is valid/prohibited.)
 - (5) [REMOTE CAL.] : Performs all calibration by contact input.
(Switch OFF to ON to perform calibration.)
 - (6) [REMOTE HOLD] : Holds the AO by contact input.
(OFF/ON: not held/held)
 - (7) [CALCULATE REST] : Resets maximum and minimum calculations of O₂ by contact input.
(Switch OFF to ON to perform calibration.)
 - (8) [OUTPUT RANGE] : Switches the range by contact input.
(OFF/ON: Range-1/Range-2)











Note) The functions other than “NONE” cannot be set for multiple contacts.

Procedure	Operation (example)	Setting the blowdown function for the contact input 1	
	Key operation	Description	Displayed message (LCD)
(1)		Display the screen on the right in accordance with the key operation summary and press the key.	
(2)	 	Use the key to select the contact input 1 setting screen. Press the key to set the value. (Also follow this procedure for the contact inputs 2 and 3.)	
(3)		Use the key to select the function for contact input 1.	
(4)		The item selected is highlighted. Press the key to set the value.	
(5)		Press the key.	
(6)		The display returns to the screen on the right.	

10.5.3 Selection of alarm contact output

Description

- You can set the alarm conditions for alarm contact output using this function.
- Settable range: Select one of the following.
 - (1) [ALARM NONE] : Alarm contact output is not performed.
 - (2) [HIGH ALARM] : Alarm contact output is performed when an high limit alarm occurs.
 - (3) [LOW ALARM] : Alarm contact output is performed when an lower limit alarm occurs.
 - (4) [HH ALARM] : Alarm contact output is performed when an HH limit alarm occurs.
 - (5) [LL ALARM] : Alarm contact output is performed when an LL limit alarm occurs.
 - (6) [H/L ALARM] : Alarm contact output is performed when an high or lower limit alarm occurs.
 - (7) [HH/LL ALARM] : Alarm contact output is performed when an HH or LL limit alarm occurs.

Procedure	Operation (example)	Setting the lower limit alarm function for alarm contact output	
	Key operation	Description	Displayed message (LCD)
(1)		Display the screen on the right in accordance with the key operation summary and press the  key.	
(2)		The selection of alarm contact output setting screen appears.	
(3)	 	Use the  key to select the low alarm. Press the  key to set the value.	
(4)		The display returns to the screen on the right.	

10.5.4 High limit setting of oxygen concentration

Description

- You can set the high limit of oxygen concentration using this function.
Use the oxygen concentration alarm 1 for the range 1, and the oxygen concentration alarm 2 for the range 2.
- Settable range: 0.001 to 55.000 vol%

Procedure	Operation (example)	Setting the high limit of oxygen concentration to “50.000 vol%” (Range 1)	
	Key operation	Description	Displayed message (LCD)
(1)		Display the screen on the right in accordance with the key operation summary and press the key.	
(2)	 	Use the key to select the oxygen concentration high limit value setting screen, and press the key.	
(3)	 	Use the and key to set the oxygen concentration high limit value. Press the key to set the value.	
(4)		Press the key.	
(5)		Press the key.	
(6)		The display returns to the screen on the right.	

Note

- A setting error occurs if the following condition is not satisfied:
“HH limit of oxygen concentration” \geq “high limit of oxygen concentration” \geq “Lower limit of oxygen concentration” \geq “LL limit of oxygen concentration”

10.5.5 Lower limit setting of oxygen concentration

Description

- You can set the lower limit of oxygen concentration using this function.
Use the oxygen concentration alarm 1 for the range 1, and the oxygen concentration alarm 2 for the range 2.
- Settable range: 0.001 to 55.000 vol%

Procedure	Operation (example)	Setting the lower limit of oxygen concentration to “00.020 vol%” (Range 1)	
	Key operation	Description	Displayed message (LCD)
(1)		Display the screen on the right in accordance with the key operation summary and press the key.	
(2)	 	Use the key to select the oxygen concentration lower limit value setting screen, and press the key.	
(3)	 	Use the and key to set the oxygen concentration lower limit value. Press the key to set the value.	
(4)		Press the key.	
(5)		Press the key.	
(6)		The display returns to the screen on the right.	

Note

- A setting error occurs if the following condition is not satisfied:
“HH limit of oxygen concentration” \geq “high limit of oxygen concentration” \geq “Lower limit of oxygen concentration” \geq “LL limit of oxygen concentration”

10.5.6 HH limit setting of oxygen concentration

Description

- You can set the HH limit of oxygen concentration using this function.
Use the oxygen concentration alarm 1 for the range 1, and the oxygen concentration alarm 2 for the range 2.
- Settable range: 0.001 to 55.000 vol%

Procedure	Operation (example)	Setting the HH limit of oxygen concentration to “55.000 vol%” (Range 1)	
	Key operation	Description	Displayed message (LCD)
(1)		Display the screen on the right in accordance with the key operation summary and press the key.	
(2)	 	Use the key to select the oxygen concentration HH limit value setting screen, and press the key.	
(3)	 	Use the and key to set the oxygen concentration HH limit value. Press the key to set the value.	
(4)		Press the key.	
(5)		Press the key.	
(6)		The display returns to the screen on the right.	

Note

- A setting error occurs if the following condition is not satisfied:
“HH limit of oxygen concentration” \geq “High limit of oxygen concentration” \geq “Lower limit of oxygen concentration” \geq “Low-Low limit of oxygen concentration”

10.5.7 LL limit setting of oxygen concentration

Description

- You can set the LL limit of oxygen concentration using this function.
Use the oxygen concentration alarm 1 for the range 1, and the oxygen concentration alarm 2 for the range 2.
- Settable range: 0.001 to 55.000 vol%

Procedure	Operation (example)	Setting the Low-Low limit of oxygen concentration to “00.010 vol%” (Range 1)	
	Key operation	Description	Displayed message (LCD)
(1)		Display the screen on the right in accordance with the key operation summary and press the key.	
(2)	 	Use the key to select the oxygen concentration LL limit value setting screen, and press the key.	
(3)	 	Use the and key to set the oxygen concentration LL limit value. Press the key to set the value.	
(4)		Press the key.	
(5)		Press the key.	
(6)		The display returns to the screen on the right.	

Note

- A setting error occurs if the following condition is not satisfied:
“HH limit of oxygen concentration” ≥ “High limit of oxygen concentration” ≥ “Lower limit of oxygen concentration” ≥ “LL limit of oxygen concentration”

10.5.8 Hysteresis Setting

Description

- You can set the hysteresis for alarm condition of oxygen concentration.
Use the oxygen concentration alarm 1 for the range 1, and the oxygen concentration alarm 2 for the range 2.
Perform the setting using the percentage (%) of the range compared to the full scale.
- Settable range: 0 to 20 %

Procedure	Operation (example)	Setting the hysteresis for alarm condition of oxygen concentration to “20%” (Range 1)	
	Key operation	Description	Displayed message (LCD)
(1)		Display the screen on the right in accordance with the key operation summary and press the key.	
(2)	 	Use the key to select the hysteresis setting screen, and press the key.	
(3)	 	Use the and key to set the hysteresis. Press the key to set the value.	
(4)		Press the key.	
(5)		Press the key.	
(6)		The display returns to the screen on the right.	

Hysteresis:

If the value fluctuates around the condition value, there is a possibility that alarms occur frequently. When determining alarms, set a hysteresis width for the condition in order to prevent chattering. For alarm check, set the percentage (%) of the range compared to the full scale as hysteresis width (see the figure below).



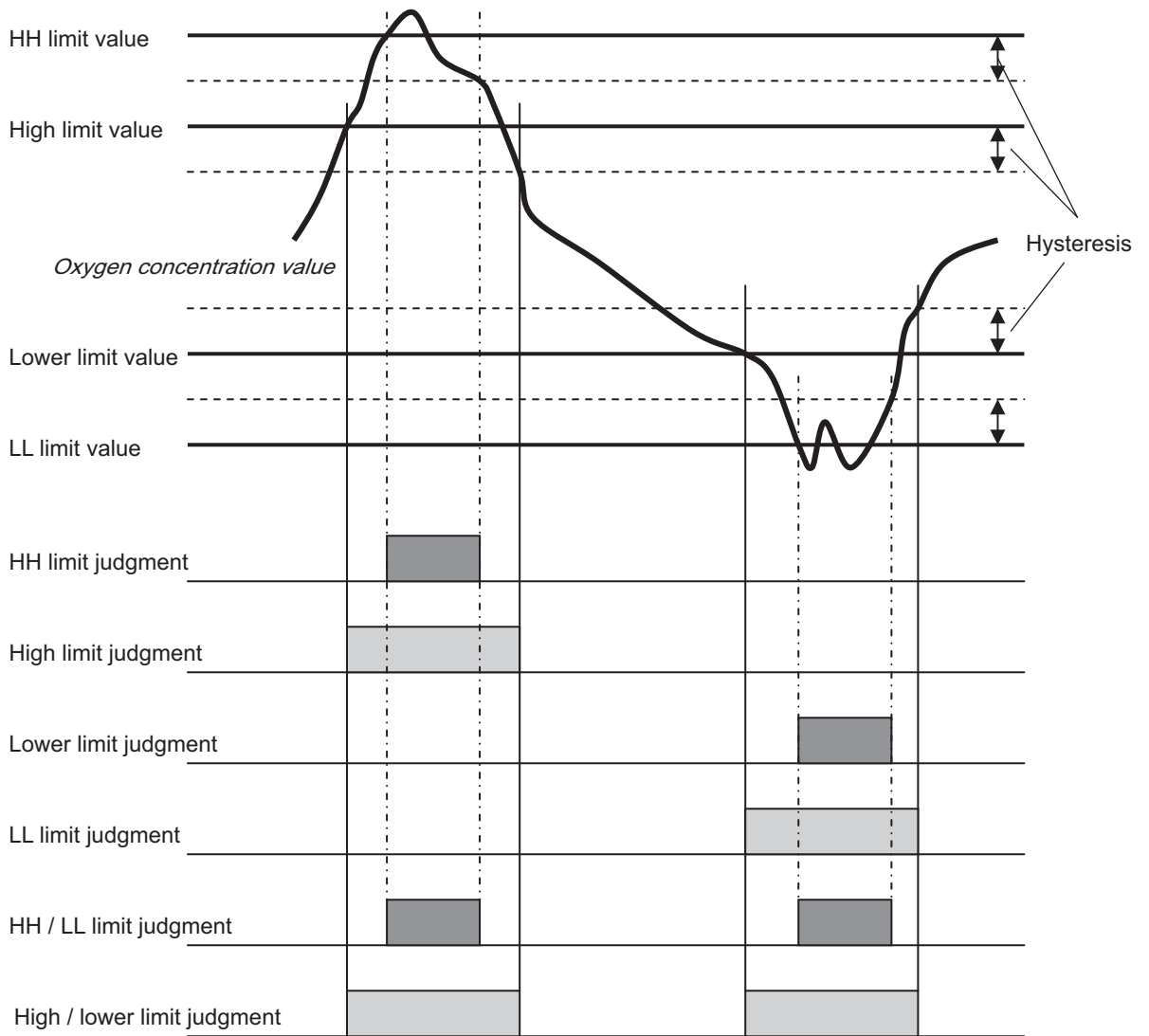











This is common among “HH limit value,” “High limit value,” “Lower limit value,” and “LL limit value.”

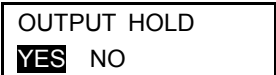

10.5.9 Hold treatment setting (maintenance hold)

Description

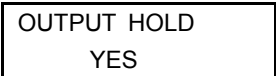
- You can set if the analog output hold function is valid or invalid using this function.
- If the analog output hold function is valid, the value set for the analog output (see “10.5.10 Hold value setting (maintenance hold)”) is held at the value set for analog output when the following treatment is performed.
 - Calibration (Auto, All, Manual, Remote)
 - Blowdown (Auto, Manual, Remote)
 - Sensor diagnosis, PID auto tuning
 - While the maintenance mode is set to “Valid.”

Procedure	Operation (example)	Setting the analog output hold function to valid	
	Key operation	Description	Displayed message (LCD)
(1)		Display the screen on the right in accordance with the key operation summary and press the  key.	
(2)		Press the  key. The analog output hold setting screen appears.	
(3)	 	Use the  key to select the output hold valid (YES). Press the  key to set the value.	
(4)		Press the  key.	
(5)		The display returns to the screen on the right.	













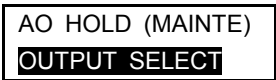

Note

- If an error occurs while the analog output hold function (error hold) is set to “Valid,” error hold processing is prioritized.
- Analog output signal during warm-up is held at 0% (4 mA/0 V).

10.5.10 Hold value setting (maintenance hold)

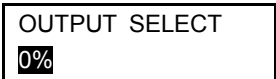
Description

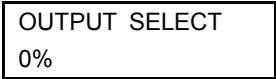











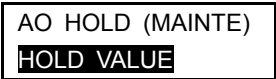

- Using this function, you can set (select) the output value of analog output signal when the analog output hold function (maintenance hold) is enabled.
- If the maintenance mode is set to “Valid,” analog output signal is held at the value set in this procedure.
- Settable range: Select one of the following.
 - (1) [0%] : Held at 0% (4 mA/0 V)..
 - (2) [100%] : Held at 100% (20 mA/1 V).
 - (3) [Last value] : Held at the value immediately before the value for analog hold.
 - (4) [Setting value] : Held at the value set as the “10.5.11 Setting of hold setting value (maintenance hold)”.

Procedure	Operation (example)	Setting the output value of analog output hold to “0%”	
	Key operation	Description	Displayed message (LCD)
(1)		Display the screen on the right in accordance with the key operation summary and press the  key.	
(2)	 	Press the  key to display the screen on the right and press the  key. The analog output hold value setting screen appears.	
(3)	 	Use the  key to select the hold value. Press the  key to set the value.	
(4)		Press the  key.	
(5)		The display returns to the screen on the right.	

10.5.11 Setting of hold setting value (maintenance hold)

Description

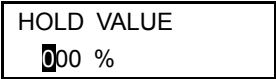
- Using this function, you can set the output value of analog output signal to an arbitrary value when the analog output hold function (maintenance hold) is enabled.
This function is to set the output value of an analog output at a percentage (%) of the full-scale value, when “setting value” is selected and specified on the “10.5.10 Hold value setting (maintenance hold).”
- Settable range: 0 to 100 %

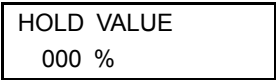
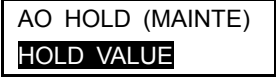
Procedure	Operation (example)	Setting the output value of analog output hold to “000%”	
	Key operation	Description	Displayed message (LCD)
(1)		Display the screen on the right in accordance with the key operation summary and press the  key.	
(2)	 	Press the  key to display the screen on the right and press the  key. The hold setting value setting screen appears.	
(3)	  	Use the  and  key to set the hold value. Press the  key to set the value.	
(4)		Press the  key.	
(5)		The display returns to the screen on the right.	

10.5.12 Setting of measurement recovery time (maintenance hold)

Description











- This function is to set the recovery time (hold of extension) from the analog output hold function (maintenance hold).
- Settable range: 0 to 300 sec.

Procedure	Operation (example)	Setting the time for extension of hold to “10 seconds”	
	Key operation	Description	Displayed message (LCD)
(1)		Display the screen on the right in accordance with the key operation summary and press the key.	
(2)	 	Press the key to display the screen on the right and press the key. The measurement recovery time setting screen appears.	
(3)	 	Use the and key to set the measurement recovery time. Press the key to set the value.	
(4)		Press the key.	
(5)		The display returns to the screen on the right.	

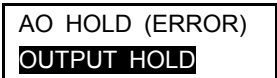
10.5.13 Hold treatment setting (error hold)

Description

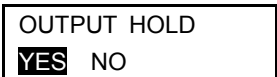
- Using this function, you can set whether the analog output hold function is valid or invalid when an error occurs.
- If the analog output hold function (error hold) is set to valid, analog output signal is held at the set value (see “10.5.14 Hold value setting (error hold)”) if an error occurs.

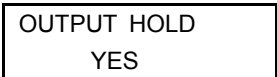
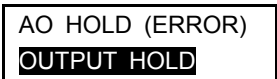
Procedure	Operation (example)	Setting the analog output hold function to valid	
	Key operation	Description	Displayed message (LCD)
(1)		Display the screen on the right in accordance with the key operation summary and press the  key.	
(2)		Press the  key. The analog output hold setting screen appears.	
(3)	 	Use the  key to select the output hold valid (YES). Press the  key to set the value.	
(4)		Press the  key.	
(5)		The display returns to the screen on the right.	

Note

- If an error occurs while the analog output hold function (error hold) is set to “Valid,” error hold processing is prioritized.
- Analog output signal during warm-up is held at 0% (4 mA/0 V).

10.5.14 Hold value setting (error hold)

Description

- Using this function, you can set (select) the output value of analog output signal when the analog output hold function (error hold) is enabled.
- If the maintenance mode is set to “Valid,” analog output signal is held at the value set in this procedure.
- Settable range: Select one of the following.
 - (1) [0%] : Held at 0% (4 mA/0 V).
 - (2) [100%] : Held at 100% (20 mA/1 V).
 - (3) [Last value] : Held at the value immediately before the value for analog hold.
 - (4) [Setting value] : Held at the value set as the “10.5.15 Setting of hold setting value (error hold)”.

Procedure	Operation (example)	Setting the output value of analog output hold to “0%”	
	Key operation	Description	Displayed message (LCD)
(1)		Display the screen on the right in accordance with the key operation summary and press the key.	
(2)	 	Press the key to display the screen on the right and press the key. The analog output hold value setting screen appears.	
(3)	 	Use the key to select the hold value. Press the key to set the value.	
(4)		Press the key.	
(5)		Press the key to return to the screen on the right.	

10.5.15 Setting of hold setting value (error hold)

Description















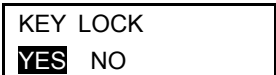

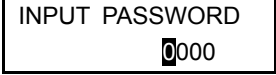
- Using this function, you can set the output value of analog output signal to an arbitrary value when the analog output hold function (error hold) is enabled.
- This function is enabled if “Setting value” is set at “10.5.14 Hold value setting (error hold).”
- Set the output value of analog output signal as a percentage (%) of the full-scale value of the display range. 0% is equivalent to 0 vol% (4 mA/0 V) and 100 % is to the full-scale value (20 mA/1 V).
- Settable range: 0 to 100 %

Procedure	Operation (example)	Setting the output value of analog output hold to “000%”	
	Key operation	Description	Displayed message (LCD)
(1)		Display the screen on the right in accordance with the key operation summary and press the key.	
(2)	 	Press the key to display the screen on the right and press the key. The hold setting value setting screen appears.	
(3)	 	Use the and key to set the hold value. Press the key to set the value.	
(4)		Press the key.	
(5)		Press the key to return to the screen on the right.	

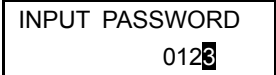
10.5.16 Setting of key lock

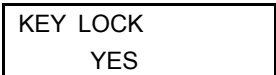
Description













- Authorized person can set if the key lock is valid or invalid using this function. You need a “password” to make a setting if the key lock is valid or invalid. Note: Refer to “Password setting” (Paragraph “10.4.7”).
- If the key lock is valid, you cannot make settings and manual operation (manual calibration, manual browdown, etc.). However, you can see the screen transition and set values.

Procedure	Operation (example)	Setting the key lock to valid (Password is assumed to be “0123”).	
	Key operation	Description	Displayed message (LCD)
(1)		Display the screen on the right in accordance with the key operation summary and press the  key.	
(2)		Use the  key to select the key lock valid (YES) or invalid (No).	
(3)		Press the  key.	
(4)	 	Use the  key and the  key to input the password.	
(5)		Press the  key.	
(6)		Press the  key to return to the screen on the right.	

10.5.17 Setting of automatic OFF time

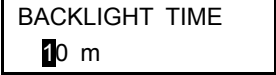
Description

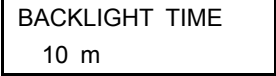











- You can set the time for automatically turning off the backlight of the LCD (screen) using this function.
When the time set for turning off the backlight elapses after the last operation, the backlight is turned off.
(Press any key to turn on the backlight.)
If 00 minutes is set, the backlight is not turned off.
- Settable range: 0 to 99 min.

Procedure	Operation (example)	Setting the time for automatically turning off the backlight to 10 minutes	
	Key operation	Description	Displayed message (LCD)
(1)		Display the screen on the right in accordance with the key operation summary and press the  key.	
(2)	  	Use the  and  key to set the automatic OFF time. Press the  key to set the value.	
(3)		Press the  key.	
(4)		The display returns to the screen on the right.	

10.5.18 Station number setting

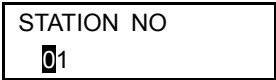
Description

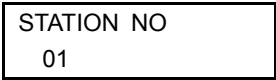

















- You can set the station number of the unit for MODBUS communication using this function.
- Settable range: 0 to 99

Procedure	Operation (example)	Setting the station number to 01	
	Key operation	Description	Displayed message (LCD)
(1)		Display the screen on the right in accordance with the key operation summary and press the  key.	
(2)	  	Use the  and  key to set the station number. Press the  key to set the value.	
(3)		Press the  key.	
(4)		The display returns to the screen on the right.	

10.5.19 Adjustment screen for analog output 0%

Description





















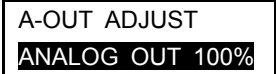



- You can adjust the analog output 0% using this function.

Procedure	Operation (example)	Adjusting the analog output 0% (4 mA)	
	Key operation	Description	Displayed message (LCD)
(1)		Connect the ammeter to the analog output terminals (5) – (6).	
(2)		Display the screen on the right in accordance with the key operation summary and press the  key.	
(3)		Press the  key. The analog output 0% adjustment screen appears.	
(4)	 	Adjust the analog output with the  and  keys. Switch between “DOWN” and “UP” with the  key. Adjust the value to 4 mA with the  key, checking the analog output with the ammeter.	
(5)	 	Press the  key to set the value. Press the  key.	
(6)		The display returns to the screen on the right.	
(7)		Remove the ammeter connected to the analog output terminals (5) – (6).	

10.5.20 Adjustment screen for analog output 100%

Description

- You can adjust the analog output 100% using this function.

Procedure	Operation (example)	Adjusting the analog output 100% (20 mA)	
	Key operation	Description	Displayed message (LCD)
(1)		Connect the ammeter to the analog output terminals (5) – (6).	
(2)		Display the screen on the right in accordance with the key operation summary and press the  key.	
(3)		Press the  key. The analog output adjustment screen appears.	
(4)	 	Press the  key. Press the  key. The analog output 100% adjustment screen appears.	
(5)	   	Adjust the analog output with the  and  keys. Switch between “DOWN” and “UP” with the  key. Adjust the value to 20 mA with the  key, checking the analog output with the ammeter. Press the  key to set the value.	
(6)		Press the  key.	
(7)		The display returns to the screen on the right.	
(8)		Remove the ammeter connected to the analog output terminals (5) – (6).	

10.5.21 Fuel coefficient setting (option)

Description

- You can set the fuel coefficient [k], which is for calculation of combustion efficiency, using this function.
- Settable range : 0.00 to 1.99

Procedure	Operation (example)	Setting the fuel coefficient [k] to 0.73.	
	Key operation	Description	Displayed message (LCD)
(1)		Display the screen on the right in accordance with the key operation summary and press the key.	
(2)		Use the key and the key to input the fuel coefficient.	
(3)		Press the key to fix.	
(4)		Press the key to return to the screen on the right.	

Calculation and display of combustion efficiency

- Using the following formula, calculate the combustion efficiency E.

$$\text{Combustion efficiency } E [\%] = 100 - \frac{\text{Fuel coefficient [k]} \times (\text{Temperature of flue gases [K]} - \text{Standard oxygen concentration value [vol\%]} - \text{Measured oxygen concentration value [vol\%]})}{\text{Temperature of flue gases [K]}}$$

Note 1: Fuel coefficient [k] is according to the fuel used.
Refer to the table below.

Note 2: Temperature of flue gases should be measured separately.
Connect the electromotive force signal of the thermocouple type temperature detector (R-type) to this unit.

*Type R or type K, depending on the model.

Note 3: The standard oxygen concentration value is to be 20.8 [vol%].

Note 4: When the internal calculation result of the combustion efficiency [E] exceeds 0 [%] ≤ E ≤ 100 [%], ****% is displayed.

Natural gas	k = 0.66
Oil	k = 0.7
Bituminous coal	k = 0.73

Note 5: Measurement range is between 0°C to 1000°C.
If the temperature exceeds the above range, “***°C” is displayed.

10.6 Factory menu

10.6.1 Password setting screen

Description

- You can input the password for authorization authentication in this screen in order to execute the factory setting menu.
Customers cannot execute the factory setting menu.
- This password is different from the password you set in “10.4.7 Password setting”.

11. SPECIFICATIONS

11.1 Specifications

General Specifications

Measuring object: Oxygen in noncombustible gas
Measuring method: Directly insert type zirconia system

Measuring range: 0 to 2 ... 50 vol% O₂
(in 1 vol% O₂ steps)

Repeatability: Within ±0.5%FS
Linearity: Within ±2%FS
Response time: Within 4 to 7 sec, for 90% (from calibration gas inlet)

Warmup time: More than 10 min
Analog output: 4 to 20mA DC (allowable load resistance less than 500Ω) or 0 to 1V DC (output resistance more than 100Ω)

Digital input (option): RS-485 or HART communication

Power supply: Rated voltage;
100 to 120V AC (operating voltage 90 to 132V AC)
200 to 240V AC (operating voltage 190 to 264V AC)
Rated frequency; 50/60Hz

Power consumption:
During warm-up 255VA
During operation 70VA
When the power supply voltage is 100 or 220 V AC

Detector Specifications (ZFK)

Measured gas temperature:
Flow guide tube system; -10 to +600°C (for general-use, corrosive gas)
Ejector system; -10 to +1500°C (for high-temperature gas)
-10 to +800°C (for general-use)

Measured gas pressure:
-3 to +3kPa

Flow guide tube: With or without blow-down nozzle
Flange; JIS5K 65A FF
(JIS5K-80AFF for high particulate gas)
Insertion length; 0.3, 0.5, 0.75, 1m

Ejector (general-use):
Probe for guiding measured gas to detector
Flange; JIS10K 65A RF
Insertion length; 0.5, 0.75, 1, 1.5m (according to customer's specification)

Ejector air inlet flow rate:
5 to 10 L/min

Ejector exhaust gas processing:
Into furnace, returned to flue

Ejector heater temperature drop alarm output:
Alarm output when below 100°C Mechanical thermostat
N.O. (1a) contact, 200V AC, 2A

Operating temperature:
-10 to +60°C for Primary detecting element
-5 to +100°C for ejector section
125°C or less at detector flange surface with power applied

*When sample gas temperature is lower than 150°C and the outside temperature is lower than 0°C, cover the flow guide tube flange and the detector (the part that contact outside air) with thermal insulating material to prevent dew condensation.

Storage temperature:
Sensing element: -20 to +70°C
Ejector: -10 to +100°C

Structure: Dust/rain-proof structure(IEC IP66 equivalent)

Filter: Alumina(filtering accuracy 50μm) and quartz paper

Main materials of gas-contacting parts:
Detector; Zirconia, SUS316, platinum
Flow guide tube; SUS304 or SUS316
Ejector (general use); SUS316, SUS304
Ejector; (for high temperature) SiC, SUS316, SUS304

Calibration gas inlet:
φ6mm tube join, φ1/4-inch tube join, or ball valve (as specified)

Reference air inlet (option):
φ6mm tube join or φ1/4-inch tube join (as specified)

Detector mounting:
Horizontal plane ±45°, ambient surrounding air should be clean.

Outer dimensions: (L × max. dia.) 210mm × 100mm (detector)

Mass (approx.) (weight):
Detector; 1.6kg
Ejector; 15kg (insertion length 1m)
Flow guide tube (general-use, 1m); 5kg

Finish color: Silver and SUS metallic color

Calibration gas flow:
1.5 to 2 L/min

Blowdown air inlet pressure:
200 to 300kPa {2 to 3 kgf/cm²}

Converter specification (ZKM)

Concentration value indication:
Digital indication in 4 digits

Contact output signal:
(1) Contact specification; 6 points, 1a 250V AC/3A or 30V DC/3A
(2) Contact function;

- Under maintenance
- Under blowdown ^{Note3)}
- Span calibration gas valve
- Zero calibration gas valve
- Instrument anomalies ^{Note1)}
- Alarm ^{Note2)}
- Range identification output ^{Note4)}

Note1) The following Instrument errors (1) Thermocouples break (2) Sensor break (3) Temperature fault (4) Calibration fault (5) Zero/span adjustment fault (6) Output error turn the contact-ON

Note2) Alarm selects just one as mentioned below (1) High (2) Low (3) Upper and Lower (4) High-high (5) Low-low, it turns ON while operating.

Note3) Under blow down is available in case of option, and it turns ON while operating.

Note4) It turns ON during range selection, and turns OFF when the range 1 is selected.

Contact input signal:

(1) Contact specification; 3points (the following option)
ON; 0V (10mA or less), OFF; 5V

(2) Contact function;

- External hold
- Calculation reset
- Heater OFF
- Blow down (option)
- Inhibition of calibration
- Calibration start
- Range change

Calibration method:

(a) Manual calibration with key operation

(b) Auto. calibration (option)

Calibration cycle; 00 day 00 hour to 99 days 23 hours

(c) All calibration

Calibration gas: • Available range settings

Zero gas; 0.010 to 25.00% O₂

Span gas; 0.010 to 50.00% O₂

- Recommended calibration gas concentration

Zero gas; 0.25 to 2.0% O₂

Span gas; 20.6 to 21.0% O₂

(oxygen concentration in the air)

Blowdown: (option)

A function for blowing out with compressed air dust that has deposited in the flow guide tube. Blowdown can be performed for a predetermined time and at predetermined intervals.

Blowdown cycle; 00 hour 00 minute to 99 hours 59 minutes

Blowdown time; 0 minute 00 second to 0 minutes 999 seconds

Output signal hold:

Output signal is held during calibration, processing diagnosis of sensor, warm-up, PID auto tuning, under set up maintenance mode "available" and blowdown. The hold function can also be released.

Valve and Flow meter (option):

Selects zero or span gas during manual zero or span calibration. Mounted on the side of the converter.

Communication function:

HART communication (option)

RS485 (MODBUS) (option)

Combustion efficiency display (option):

This function calculates and displays combustion efficiency from oxygen concentration and measured gas temperature.

Thermocouple (R) or thermocouple (K) is required for temperature measurement.

Range: 0 to 1000°C, Accuracy: ±5°C.

On the version with combustion efficiency display, an alarm function of "rich mode" indication is also available.

Operating temperature:

-20 to +55°C

Operating humidity:

95% RH or less, non condensing

Storage temperature:

-30 to +70°C

Storage humidity: 95% RH or less, non condensing

Enclosure: Dust-proof, rainproof

(corresponding to IP66 or IP67 of IEC)

*when the specified cable gland is attached.

Material: Aluminum case

Outer dimensions (H x W x D):

170 X 159 X 70mm (IP66, Bench type)

220 X 230 X 95mm (IP67)

Mass (weight):

IP66: Approx. 2kg (excluding cable and detector)

IP67: Approx. 4.5kg (excluding cable and detector)

Cable: Approx. 4kg/m (with rainproof flexible conduit)

Finish color:

Case: Silver

Cover: Munsell 6PB 3.5/10.5 (blue)

Mounting method: Mounted flush on panel or on pipe

EU Directive Compliance 

LVD (2014/35/EU)

EN 61010-1

EN 62311

EMC (2014/30/EU)

EN 61326-1 (Table 2)

EN 55011 (Group 1 Class A)

EN 61000-3-2 (Class A)

EN 61000-3-3

EN 61326-2-3

RoHS (2011/65/EU)

EN 50581

*Ejector ZTA is non-compliant with CE marking.

11.2 Code symbols

<Converter>

4 5 6 7 8 9 10 11 12 13 14 15 16
ZKM 2 - 1 - Y R

Digit	Description		Note	Code
4	Enclosure	IP66		A
		IP67		B
5	Analog output signal	4 to 20 mA DC		B
		0 to 1 V DC		E
6	Communication function	None		Y
		RS-485		2
		HART		3
7	Mounting bracket	None		Y
		Mounting on panel surface		1
		Pipe mounting		2
8	Revision No.			2
9	Optional functions	None		Y
		Combustion efficiency display	Note 1	1
		Blowdown		2
		Auto calibration		3
		Combustion efficiency display + Blowdown	Note 1	4
		Combustion efficiency display + Auto calibration	Note 1	5
		Blowdown + Auto calibration		6
Combustion efficiency display + Blowdown + Auto calibration	Note 1	7		
10	Language	Japanese		J
		English		E
		Chinese		C
11	Selector valve/ flowmeter	None	Note 2	Y
		With valve (For ø6 mm tube)		1
		With valve + flowmeter (For ø6 mm tube)		2
		With valve (For ø1/4 inch tube)		3
		With valve + flowmeter (For ø1/4 inch tube)		4
12	—	—		1
13	Cable gland	Without		Y
		With		A
14	—	—		Y
15	—	—		R
16	Thermocouple for combustion efficiency display	None	Note 3	Y
		Type R thermocouple	Note 3	R
		Type K thermocouple	Note 3	K
*Thermocouple is to be prepared separately.				

Notes

1. On the version with the combustion efficiency display, the rich mode indicator is available. If you order the version with combustion efficiency display (9th code 1, 4, 5, or 7), select "R" or "K" in the 16th digit.
2. If you order the version with auto calibration (9th code 3, 5, 6, or 7), select "Y" in the 11th digit.
3. If you order the version without combustion efficiency display (9th code Y, 2, 3, or 6), select "Y" in the 16th digit.

<Detector>

4 5 6 7 8 9 10 11 12 13 14 15 16

ZFK 8 R 5 - - 1

Digit	Description		Note	Code
6	Calibration gas inlet	For ø 6mm tube (SUS)		1
		For ø 1/4 inch tube (SUS)		2
		With ball valve		3
7	Power supply	100 to 120 V AC 50/60 Hz		1
		200 to 240 V AC 50/60 Hz		3
8	Revision No.			5
9	Flow guide tube			
10	flange	application		
11	no tube			0Y0
	SUS304	general use	300 mm	5A3
	SUS304	general use	500 mm	5A5
	SUS304	general use	750 mm	5A7
	SUS304	general use	1000 mm	5A1
	SUS316	for corrosive gas	300 mm	5B3
	SUS316	for corrosive gas	500 mm	5B5
	SUS316	for corrosive gas	750 mm	5B7
	SUS316	for corrosive gas	1000 mm	5B1
	SUS316	with blowdown nozzle	300 mm	5C3
	SUS317	with blowdown nozzle	500 mm	5C5
	SUS318	with blowdown nozzle	750 mm	5C7
	SUS319	with blowdown nozzle	1000 mm	5C1
	SUS316	for high particulate	300 mm	6D3
	SUS317	for high particulate	500 mm	6D5
	SUS318	for high particulate	750 mm	6D7
	SUS319	for high particulate	1000 mm	6D1
	SUS316	for high particulate with cover	300 mm	6E3
	SUS317	for high particulate with cover	500 mm	6E5
	SUS318	for high particulate with cover	750 mm	6E7
	SUS319	for high particulate with cover	1000 mm	6E1
	Others			ZZZ
12	Heat-retaining cover	Without		Y
		With		A
13	Reference gas inlet	None		Y
		For ø 6 mm tube (SUS)		A
		For ø 1/4 inch tube (SUS)		B
14	Filter spec	Standard		1
15	Instruction manual language	Japanese		J
		English		E
		Chinese		C
16	Specification nameplate	Standard (100 to 120 V AC 50/60 Hz)		1
		Standard (200 to 240 V AC 50/60 Hz)		2

<Ejector>

4 5 6 7 8

ZTA 1 1

Digit	Description		Note	Code
4	Measured gas temperature	For high temperature (+1500°C max.)		1
		General use (+800°C max.)		2
5	—	—		1
6	Insertion length [mm]	500		B
		750		C
		1000		D
		1500		E
7	Power supply voltage	100V/115 V AC 50/60Hz		1
		200V/220 V AC 50/60Hz		3
		230 V AC 50/60Hz		5
8	Revision No.	—		1

<Exclusive cable>

4 5 6 7 8 9

ZRZ K R 1 -

Digit	Description		Note	Code		
4	Connectable device	ZKM		K		
5	Type	R thermocouple		R		
6	Length	Rainproof flexible conduit	Cable			
7		None	6 m		YA	
		None	10 m		YB	
		None	15 m		YC	
		None	20 m		YD	
		None	30 m		YE	
		None	40 m		YF	
		None	50 m		YG	
		None	60 m		YH	
		None	70 m		YJ	
		None	80 m		YK	
		None	90 m		YL	
		None	100 m		YM	
		6 m	} Note 1	6 m	Note 4	AA
		10 m		10 m	Note 4	BB
15 m		15 m	Note 4	CC		
20 m		25 m	Note 4	DD		
8	Revision No.	—		1		
9	Cable end treatment	None		0		
		One side (detector side)		1		
		Both sides		2		

Note 4) For connection between detector and converter, use a rainproof flexible conduit.

Fuji Electric Co., Ltd.

Instrumentation & Sensors Planning Dept.
1, Fuji-machi, Hino-city, Tokyo 191-8502, Japan
<http://www.fujielectric.com>
Phone: +81-42-514-8930 Fax: +81-42-583-8275
<http://www.fujielectric.com/products/instruments/>
