

TIME DELTA SERIES
ULTRASONIC FLOWMETER <M-Flow PW >
DATA SHEET
FLR-3, FSS, FLY

This flowmeter is a clamp-on type ultrasonic flow meter based on transit-time measuring method. Making full use of the latest electronics and digital signal processing technologies, we realized the equipment with improved anti-bubble performance and high accuracy. The communication function (MODBUS: Option) is also applicable.

FEATURES
1. Excellent resistance against aerated flow

Fuji's unique ABM feature improves measurement reliability for different flow like slurries, sludge, raw sewage and bubble-contained flow (acceptable up to air bubble of 12% volume at 1m/s velocity).

2. High accuracy

Standard accuracy: $\pm 1.5\%$ ($\pm 1.0\%$ is also available)
Adoption of new sound velocity measurement system permits measurements of fluids of unknown sound velocity. Further, affection from fluid temperature and pressure is negligible.

3. Compact and light-weight

Thanks to the adoption of the latest electronics, the flow transmitter is compact size and light weight.

4. Quick response

With the use of high-speed micro-processor suited for digital signal processing, the fast response time is realized.

5. Multi-lingual

The following languages are supported for display:
Japanese (Katakana), English, German French, and Spanish.

6. Excellent performance and easy operation

LCD and function keys are allowing easy configuration and trouble shooting.

- LCD with back light
- Easy mounting of sensor
- Extendable rail type detector up to $\Phi 50$ to $\Phi 1200\text{mm}$
- Trouble shooting
- Easy operation with keypad on the front surface of the flow transmitter



Flow transmitter (FLR)



Detector (FSSA)

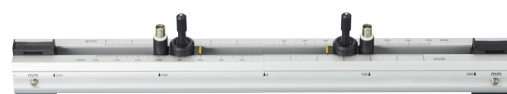

Detector (FSSC)

SPECIFICATIONS
Operational specifications
System configuration:

Single-path system of a flow transmitter (Model FLR) and a detector (Model FSS)

Applicable detector:

FSSA (2MHz), FSSC (1MHz)

Applicable fluid:

Homogenous liquid where the ultrasonic signal can be transmitted

Bubble quantity: 0 to 12vol% (for pipe size 50A, water, velocity 1m/s)

Fluid turbidity: 10000mg/L max.

Type of flow: Fully-developed turbulent or laminar flow in a full-filled pipe

Flow velocity range:

0 to $\pm 0.3 \dots \pm 10\text{m/s}$

Power supply: 100 to 240V AC +10%/-15%, 50/60Hz;
or 20 to 30V DC

Signal cable (between detector and converter):
Coaxial cable (5m standard, 60m max.)
Heat resistance: 80°C

Installation environment:
Non-explosive area without direct sunlight,
corrosive gas and heat radiation.

Ambient temperature:
Flow transmitter: -20 to +50°C
Detector: -20 to +60°C

Ambient humidity:
90%RH max.

Grounding: Class D (100 Ω or less)

Arrester: Provided as standard at power supply

Applicable piping and fluid temperature:

Detector Type	Pipe size (inner diameter)	Applicable pipe material	Mounting method	Fluid temperature range (Note 3)
FSSA	ø25 to ø50 mm	Plastic (PVC, etc.) (Note 1)	V method	-20 to +100°C Heat shock resistance 150°C, 30min
	ø50 to ø225 mm	Plastic (PVC, etc.) (Note 1) Metal pipe (SS, steel pipe, copper pipe, aluminum pipe, etc.) (Note 2)		
FSSC	ø50 to ø600 mm		Z method	-40 to 120°C
	ø200 to ø1200 mm			

Note 1: Limit of pipe wall thickness for FSSA: 15mm or less for PP, 9mm or less for PVDF

Note 2: For cast iron pipe, lining pipe, old steel pipe or others through which the ultrasonic signal could not be transmitted easily, select FSSC.
Lining material: Tar epoxy, mortar, rubber, etc.

* In case the lining is not glued to a pipe, the measurement may be impossible.

Straight pipe length: Typically 10D for upstream and 5D for downstream.
(D: Pipe inner diameter)

Refer to conditions on straight pipe for details
(Japan Electric Measuring Instruments Manufacturers' Association Standard JEMIS-032).

Note 3: If silicone-free grease is used as acoustic coupler, the fluid temperature range is 0 to 60°C regardless of the detector.

Note 4: For pipes with a diameter of 300 mm or larger, we recommend to use FSSC and mount it by Z method.

Performance specifications

Rated accuracy:

<Standard type>

Plastic pipe

Detector Type	Internal diameter	Velocity: 2m/s or higher	Velocity: Less than 2m/s
FSSA	ø25 to ø50mm	±2.5% of rating	±0.05m/s
FSSA, C	ø50 to ø1200mm	±1.5% of rating	±0.03m/s

Metal pipe

Detector Type	Internal diameter	Velocity: 2m/s or higher	Velocity: Less than 2m/s
FSSA, C	ø50 to ø1200mm	±2% of rating	±0.04m/s

<High accuracy type>

Plastic pipe and metal pipe

Detector Type	Internal diameter	Velocity: 2m/s or higher	Velocity: Less than 2m/s
FSSA	ø50 to ø225mm	±1.0% of rating	±0.02m/s
FSSC	ø200 to ø1200mm	±1.0% of rating	±0.02m/s

Response time: 0.5s (standard mode)
0.2s as selected (quick response mode)

Power consumption:
15VA max. (AC power supply)
6W max. (DC power supply)

Functional specifications

Analog signal: 4 to 20mA DC (1 point)
Load resistance: 600Ω max.

Digital output: Forward total, reverse total, alarm, acting range, flow switch, total switch assignable arbitrarily
Transistor contact (isolated, open collector)
• Outputs: 2 points
• Normal: ON/OFF selectable
• Contact capacity: 30V DC, 50mA
• Output frequency: 1000P/s max. (pulse width: 5, 10, 50, 100, 200, 500, 1000ms)

Serial communication (option):

RS-485 (MODBUS), isolated
Connectable quantity: 31 units
Baud rate: 9600, 19200, 38400bps
Parity: None/Odd/Even selectable
Stop bits: 1 or 2 bits selectable
Cable length: 1km max.
Data: Flow velocity, flow rate, forward total, reverse total, status, etc.

Display device: 2-color LED (Normal: green, Extraordinary: red)
LCD with 2 lines of 16 characters and back light

Indication language:

Japanese (Katakana)/English/French/German/Spanish (changeable)

Flow velocity/flow rate indication:

Instantaneous flow velocity, instantaneous flow rate indication (minus indication for reverse flow)

Numerals: 8 digits (decimal point is counted as 1 digit)

Unit: Metric/Inch system selectable

	Metric system	Inch system
Velocity	m/s	ft/s
Flow rate	L/s, L/min, L/h, L/d, kL/d, ML/d, m³/s, m³/min, m³/d, km³/d, Mm³/d, BBL/s, BBL/min, BBL/h, BBL/d, kBBL/d, MBBL/d	gal/s, gal/min, gal/h, gal/d, kgal/d, Mgal/d, ft³/s, ft³/min, ft³/d, Kft³/d, Mft³/d, BBL/s, BBL/min, BBL/h, BBL/d, kBBL/d, MBBL/d

Note: The "gal" means USgal.

Total indication: Forward or reverse total value indication (negative indication for reverse direction)

Numerals: 8 digits (decimal point is counted as 1 digit)

Unit: Metric/Inch system selectable

	Metric system	Inch system
Total	mL, L, m³, km³, Mm³, mBBL, BBL, KBBL	gal, kgal, ft³, kft³, Mft³, mBBL, BBL, KBBL, ACRE-ft

Configuration: Fully configurable from the 4-key pad (ESC, △, ▽, ENT)

Zero adjustment: Set zero/Clear available

Damping: 0 to 100s (every 0.1s) for analog output and flow velocity/flow rate indication

Low flow rate cutoff:

0 to 5m/s in terms of flow velocity

Alarm: Digital output available for Hardware fault or Process fault

Burnout: Analog output: Hold/Overscale/Under-scale/Zero selectable

Flow rate total: Hold/Count selectable
Burnout timer: 10 to 900s (every 1s)

- Bi-directional range:**
Forward and reverse ranges configurable independently.
Hysteresis: 0 to 10% of working range
Working range applicable to digital output
- Auto-2 range:**
2 forward ranges configurable independently
Hysteresis: 0 to 10% of working range
Working range applicable to digital output
- Flow switch:**
Lower limit, upper limit configurable independently
Digital output available for status at actuated point
- Total switch:**
Forward total switching point configurable
Digital output available when actuated
- External total preset:**
Preset total settable upon contact input setting
- Backup of power failure:**
backup by non-volatile memory

Physical specifications

- Type of enclosure:**
Flow transmitter: FLR: IP65
Detector:
FSSA, FSSC:
IP65 (When waterproof BNC connector is provided)
- Mounting method:**
Flow transmitter: Mounted on wall or by 2B pipe
Detector: Clamped on pipe surface
- Acoustic coupler:**
Silicone rubber or silicone-free grease
Note: The acoustic coupler is a medium that eliminates a gap between detector and pipe

Type of acoustic coupler:

Type	Silicone rubber (KE-348W)	Silicone-free grease (HIGH Z)
Fluid temperature	-40 to +150°C	0 to +60°C
Teflon piping	×	○

In case of Teflon piping, use grease.

- Material:**
Flow transmitter: Plastic alloy
Detector:

Detector Type	Sensor housing	Guide rail
FSSA	PBT	SUS304
FSSC	PBT	Aluminum alloy + plastic

- Signal cable:**
Type: FLYA
• Structure: Heat-resisting high-frequency coaxial cable (3D2V)
• Sheath: Flame-resisting PVC
• Outer diameter: ø5mm
• Termination: Bar terminal (flow transmitter side) and BNC connector (sensor side)
• Mass: Approx. 45g/m
- Dimensions:**
Flow transmitter:
H140×W137×D68mm
Detector: H50×W348×D34mm (FSSA)
H88×W480×D53mm (FSSC)

- Mass:**
Flow transmitter: 0.8kg
Detector: 0.4kg (FSSA)
1.0kg (FSSC)
- External terminal of flow transmitter:**
plug terminal

EU Directive Compliance

- LVD (2014/35/EU)**
EN 61010-1
- EMC (2014/30/EU)**
EN 61326-1 (Table 2)
EN 55011 (Group 1 Class A)
EN 61000-3-2 (Class A)
EN 61000-3-3
EN 61326-2-3
- RoHS (2011/65/EU)**
EN 50581

PC Loader software

- Provided as standard
- Compatible model is PC/AT compatible instrument.
 - Operation is undefined for PC98 series (NEC).
 - Main functions: Software for Main unit parameter setting/change on PC
 - OS: Windows 2000/XP or Windows 7 (Home Premium, Professional)
 - Memory requirement: 125MB min.
 - Disk unit: CD-ROM drive compatible with Windows 2000/XP or Windows 7 (Home Premium, Professional)
 - Hard disk capacity: Minimum vacant capacity of 52MB or more

Note: Optional communication board (specified at the 6th digit of code symbols).

Note: Communication converter

For the PC that supports RS-232C serial interface, RS-232C - RS-485 converter is needed for connecting the PC and main unit.

For the PC that does not support RS-232C serial interface, additionally, USB - RS232C converter is also needed.

<Recommendation>

[RS-232C - RS-485 converter]
RC-770X(manufactured by SYSMEX RA)

[USB - RS-232C converter]
USB-CVRS9 (manufactured by SANWA SUPPLY)

MEASURING PRINCIPLE

With ultrasonic pulses propagated diagonally between the upstream and downstream sensors, flow rate is measured by detecting the time difference obtained by the flow of fluid.

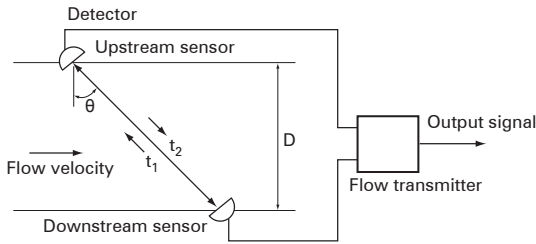

CONFIGURATION DIAGRAM

(1) Single-path system (V method)

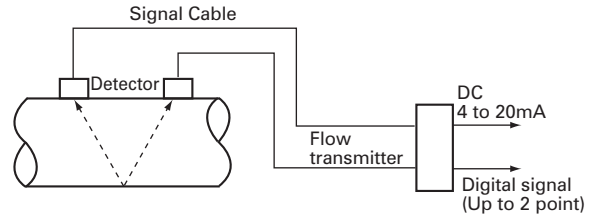

(2) Single path system (Z method)

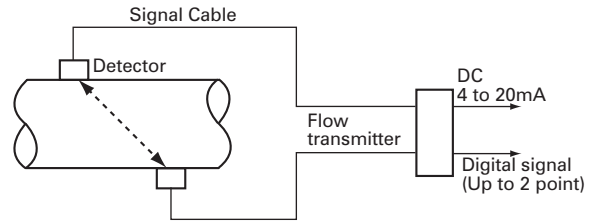

MOUNTING OF DETECTOR

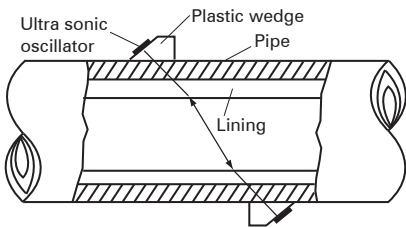

Conditions on straight pipe

(D : Inside diameter of pipe)

Classification	Upstream side	Downstream side
90 bend		
Tee		
Diffuser		
Reducer		
Various Valve		
Pump		

(Note) The source : JEMIS-032

CODE SYMBOL

<Flow transmitter>

1	2	3	4	5	6	7	8	9	10	11	12	Description
F	L	R	E	Y	3	1						Type (4th digit) Standard for exports
			E									Power Supply (5th digit) 100 to 240Vac, 50/60Hz 20 to 30Vdc
			1									Communication and Synchronization (6th digit) None RS-485
			4									Case structure (9th digit) Jetproof type (IP65)
				Y								Mounting bracket (10th digit) For 2B pipe mount For wall mount
				D								Parameter setting, tag plate (11th digit) Without With setting With setting (Tag plate) With Tag plate
								1				Measurement accuracy (12th digit) Standard High accuracy type (Pipe diameter ϕ 50mm or more)

<Detector>

1	2	3	4	5	6	7	8	9	10	Description
F	S	S	A	1				1	Y	<Senser type> (4th digits) ϕ 25 to ϕ 225mm (V method) -20 to 100°C
			A							<Guide rail> (5th digits) Provided
			1							<Mounting belt> (6th digits) None Stainless belt (1.0m X2)
				Y						<Acoustic coupler> (7th digit) (Note 1) None Silicon rubber Silicon-free grease
				A						
				B						
								Y		<Water-proof treatment> (9th digit) None
										<Tag plate> (10th digit) None Provided
								Y		
								A		

Note 1: Normally select silicone rubber as acoustic coupler. Silicone rubber in tube (100g) is furnished. If you place an order for several units, 1 tube may suffice for every 5 units. Select silicone-free grease for semiconductor manufacturing equipment or the like that is vulnerable to silicone. The silicone-free grease is water-soluble and, therefore, cannot be used in environment exposed to water or on piping subjected to a condensation. Since the grease does not set, a periodic maintenance (cleaning, refilling every about 6 months at normal temperature) is necessary.

Belt appearance for attachment of the detector.

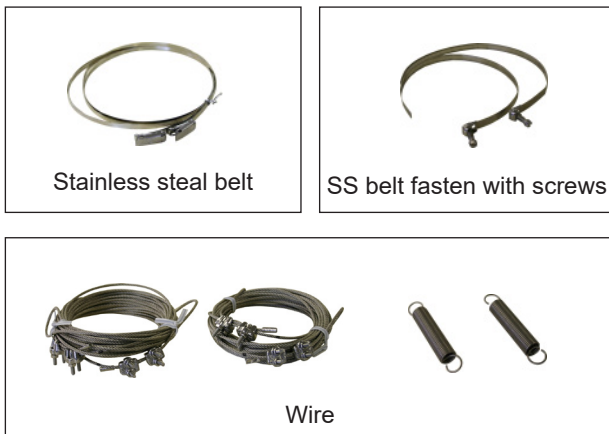

<Detector • Rail extension type>

1	2	3	4	5	6	7	8	9	10	Description
F	S	S	C	1				1	Y	<Senser type> (4th digits) ϕ 50 to ϕ 1200mm -40 to 120°C
			C							<Guide rail> (5th digits) Standard (Rail extension type)
				1						<Mounting belt> (6th digits) *2 None Stainless steel belt $\leq \phi$ 300mm (1.5m x 2pcs) SS belt fasten with screws $\leq \phi$ 600mm (1m x 4pcs) Wire $\leq \phi$ 1500mm (5m x 2pcs)
				Y						<Acoustic coupler> (7th digit) (Note 1) None Silicon rubber Silicon-free grease
				A						
				B						
								Y		<Water-proof treatment> (9th digit) None
										<Tag plate> (10th digit) None Provided
								Y		
								A		

Note2) Please refer to the table 1 for mounting belt to be selected at 6th digits.

[Table 1] How to select at 6th digits.

Mounting method	$\leq \phi$ 300mm	$\leq \phi$ 600mm	$\leq \phi$ 1200mm
V method	A or C	C	D
Z method	C	D	D

Explanation of the extendable rail type detector

■ Unextended condition



available pipe diameter up to ϕ 50 to ϕ 300mm

<V method>

■ Extended condition



available pipe diameter up to ϕ 600mm

<V method>

■ Installation of the supplied rail end.



available pipe diameter up to ϕ 1200mm

<Z method>

<Signal cable>

1	2	3	4	5	6	7	8	Description
F	L	Y	A				1	Type of sensor (4th digit code) for FSSA, FSSC
			A					Cable length (5, 6 and 7th digit)
				0	0	5		5 m
				0	1	0		10 m
				0	1	5		15 m
				0	2	0		20 m
				0	2	5		25 m
				0	3	0		30 m
				0	4	0		40 m
				0	5	0		50 m
				0	6	0		60 m
				Z	Z	Z		Others (contact us)

OUTLINE DIAGRAM (Unit:mm)

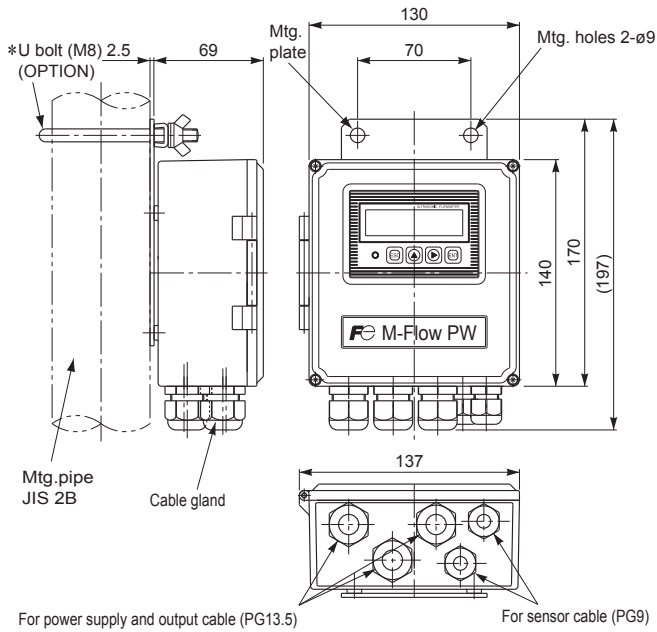

Flow transmitter : Type FLR

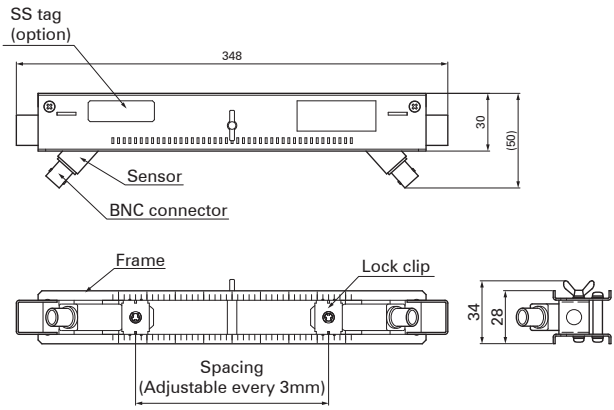

Detector : Type FSSA

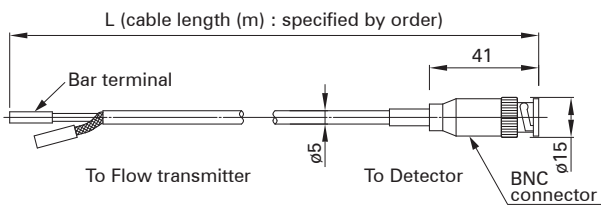

Signal cable : Type FLYA

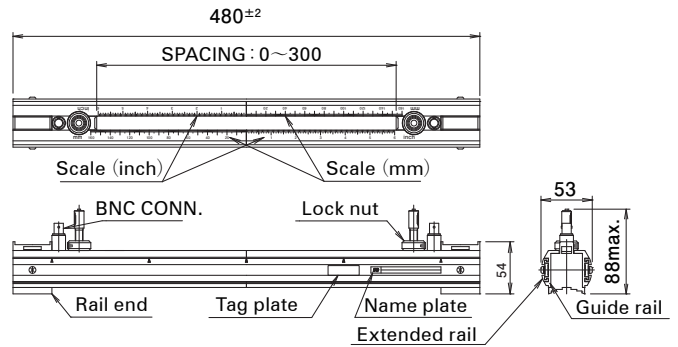

<Shipment style (V Method)>

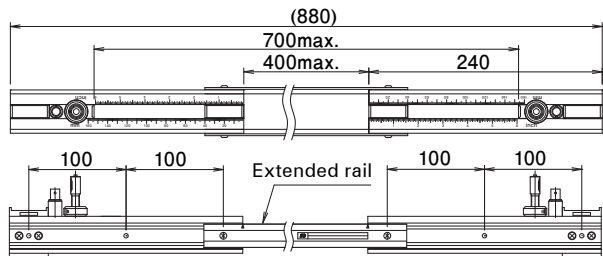

<Extended style (Longest, V Method)>

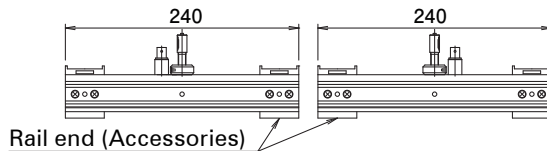

<Separate style (Z Method)>

Detector : Type FSSC

CONNECTION DIAGRAM

<Flow transmitter>

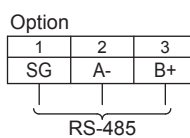
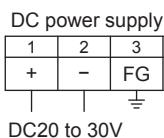
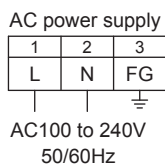

<Detector>

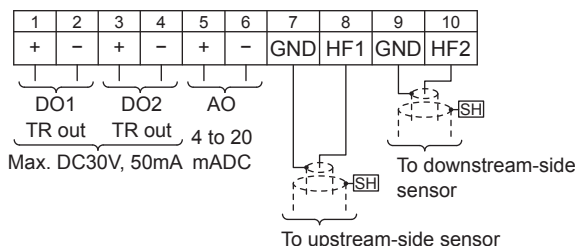
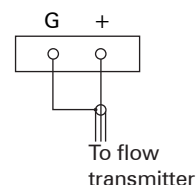

Usable wiring material

• Wire

Gauge: AWG20 (0.5mm²) to AWG16 (1.5mm²)
Strip-off length: 8~10mm

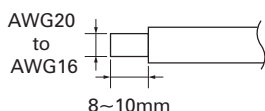

• Bar terminal

Weidmüller
www.weidmuller.com

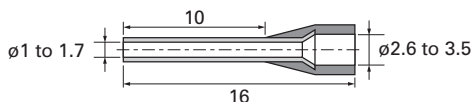

SCOPE OF DELIVERY

- Flow transmitter (provided with U-bolt and nuts for pipe mount)
- Detector (provided with mounting fixture and acoustic coupler)
- Signal cable
- CD-ROM (contains instruction manual, loader software)

ITEMS DESIGNATED ORDERING

1. Detector code symbols
2. Flow transmitter code symbols
3. Signal cable code symbols
4. Tag No. as necessary (up to 8 alphanumeric characters)
5. If parameter setting is specified, send back the attached parameter specification table duly filled.

OPTIONAL ACCESSORIES

	Name	Drawing No.
1	Silicone rubber (KE348W)	ZZP*45735N2
2	Silicone-free grease (HIGH-Z)	ZZP*TK7M0981P1
3	Stainless steel belt (1.5m x 2pcs)	ZZP*TK7L6658P4
4	SS belt fasten with screws (1m x 4pcs)	ZZP*TK7M7073P1
5	Wire set (5m x 2pcs)	ZZP*TK7N5813C4

Checked items before purchase

Following conditions may cause failure of the measurement or to reduce the accuracy by this flow meter.

Please consult and ask Fuji Electric for checking with actual equipment previously if you have hard to judge the appropriate application.

1) Fluid

- If fluid contains a large amount of bubbles (approx. 12vol% or more at 1m/s flow rate)
- If fluid has bad turbidity 10000(mg/L) or more,
- If fluid contains slurry or solid materials (about 5wt%)
- If flow rate is low Reynolds No.10000 or less, (reference: flow rate 5m³/h with ø100mm)
- If it is circulating oil, liquid medicine of low concentration, waste liquid and hot spring,

2) Pipe

- If inside pipe is rusty carbon steel pipe,
- If inside pipe having adhering substances and sediment
- If outer surface of cast-iron pipe is rough,
- If pipe wall is tick such as ruinous pipe, (PP material 15mm or more, PVDF material 9mm or more)
- If it is SGPW pipe,
- If lining pipe is removed from pipe, (Teflon, PVC, Glass)
- If it is rubber pipe,

3) Length of the straight pipe

For accurate measurement, straight pipes are needed between up and down stream side of the measuring part. Please meet the straight pipe conditions according item4.

Caution on use

- 1) Do not damage the sensor or signal mounted on the pipe.
- 2) Make sure to fill the fluid inside the pipe to measure.
- 3) When you use horizontal pipe, it is recommended to install the sensor horizontally.
- 4) When you use the grease as acoustic coupler to install the sensor for outdoor use, it is recommended to install the waterproof cover to prevent from the degradation.

<Parameter specification table>

Setting item		Initial value	Setting value	Setting item		Initial value	Setting value			
ID No		0000		Total output		Total mode	Stop			
Language		English				Total rate	0m ³			
Measuring conditions	System unit	Metric				Total preset	0m ³			
	Flow unit	m ³ /h				Pulse width	50.0msec			
	Total unit	m ³				Burnout (total)	Hold			
	Outer diameter	60.00mm		Burnout timer	10sec					
	Pipe material	PVC pipe		Output conditions		DO1 output type (Note 1)	Not used			
	Wall thickness	4.00mm				DO1 output actuation	ON when actuated			
	Lining material	Without lining				DO2 output type	Not used			
	Lining thickness	-				DO2 output actuation	ON when actuated			
	Kind of fluid	Water				Operation mode	Standard			
	Viscosity	1.0038 × 10 ⁻⁶ m ² /s								
	Sensor mount	V metod								
	Sensor type	FSSA								
	Output conditions		Damping			5.0sec	Communication		Communication mode	RS-485
Cut off			0.150m ³ /h			Baud rate			9600bps	
Display			1st line			Flow velocity (m/s)			Parity	Odd
			1st line decimal point position			****.***			Stop bit	1 bit
2nd line			Flow rate (m ³ /h)			Station No.			1	
2nd line decimal point position			****.***							
Analog output			Range type	Flow rate						
			Range type	Single range						
			Full scale 1	15.000m ³ /h						
			Full scale 2	0.000m ³ /h						
			Range HYS.	10.00%						
			Burnout (current)	Hold						
			Burnout timer	10sec						
	Output low limit	-20%								
Output high limit	120%									
Rate limit	0.000m ³ /h									
Rate limit timer	0sec									

Note1: When total pulse output has been selected for DO1, DO2 specify total pulse value and total pulse width so that conditions 1 and 2 shown below are satisfied.

$$\text{Condition 1 : } \frac{\text{Flow span-1} \times [\text{m}^3/\text{s}]}{\text{total pulse value} \times [\text{m}^3]} \leq 100[\text{Hz}]$$

$$\text{Condition 2 : } \frac{\text{Flow span-1} \times [\text{m}^3/\text{s}]}{\text{total pulse value} \times [\text{m}^3]} \leq \frac{1000}{2 \times \text{total pulse width} [\text{ms}]}$$

* In the case of 2 ranges, perform calculations using either flow span-1 or flow span-2, whichever is greater.



Fuji Electric France S.A.S.

46, rue Georges Besse - ZI du Brézet - 63039 Clermont-Ferrand Cedex 2 - France
 Tél. France 04 73 98 26 98 - Fax. 04 73 98 26 99 - Tel. international +33 4 73 98 26 98 - Fax. +33 4 73 98 26 99
 Email : sales.dpt@fujielectric.fr - Web : www.fujielectric.fr