

Digital Controller <PXH>

**Easy configuration with pre-installed
Application Templates**



1/4 DIN (96×96mm)



- **High Speed control-50ms Input sampling**
- **Motorized Valve control (Position feed back/Servo control)**
- **Dual PID Controller (Heat/Cool controller)**
- **High Accuracy-0.1%**
- **Extensive number of I/O points** (AI: 3 points, DI: 9 points, DO: 9 points, AO: 2 points)
- **Enhanced Math Functions**
- **Totalize Function**
- **RS-485 Modbus Communications and Transmitter Power Supply options available**

HIGH SPEED, HIGH ACCURACY

50ms sampling cycle and 0.1% accuracy offer precise control.



Easy-to-view 5 digit display

0.0°C can be indicated.

input Universal-input (max. 2 points)

Thermocouple, RTD, voltage or current input is switchable on the front panel keys.

input Digital-input (Max. 9 points)

Applicable to SV/PID set, AT Start/Stand-by, Remote/Auto/Manual switch, Alarm-latch clear, et. al.

input Auxiliary Analog input (1 point)

Applicable to flow compensation and remote SV setting.

Math functions

Flow compensation, High/Low selector control, ratio, calorie calculation, et. al.

PC loader interface and software through RS-232C Communication

The loader software enables easy parameter setup.

Totalize Function

Recipe Function

Input Linearize Function

output Control-output (3 types)

Selectable as relay, SSR/SSC drive and current.

output Digital-output (Max. 9 points)

Various event data as alarm and timer output are available.

output Auxiliary Analog output (Max. 2 points)

Max. two points out of PV/SV/MV/DV are available as analog output.

Transmitter Power Supply (Option) 24V DC, 23mA max.

RS485 Modbus communication function (option)

64step ramp/soak function

PID Palette

Max. 7 combinations of SV, PID are available.

Quick PID

ensures precise control to prevent overshoot and improve response to disturbances.

Applicable to various process controls including flow control and pressure control.



User friendly, Easy-to-view

Status indicator
displays SV select No. (at operation) and parameter No. (at setting)

Bargraph indicator
displays MV (12 segments)

Waterproof construction
is equipped on front panel as standard. NEMA4x (IEC standard IP66 equivalent)

Mode indicator
displays status as stand-by, control mode, output, alarm, etc.

PV indicator
has 5 digit display. 0.01°C indication is possible. (Character height : 20mm)

SV/MV indicator
displays SV and MV. (Character height : 13mm)

User function keys
offer one touch operation for Remote/ Auto switch, Stand-by, Alarm-latch clear, AT, etc. is definable by user.



Application Template

Pre-installed programming templates allow easy configuration for various applications.

Just by selecting appropriate "Application Template", input/output setting and internal calculation blocks can be automatically configured.

Template (Control Type)
Position proportional control type
Position feedback control type
Dual control type (Heat/Cool)
2 position control type
2 inputs switching control type
2 inputs selection control type
Feed forward control type
Ex-MV balance bumpless switching type
⋮

"Application Templates" are pre-installed.

- PID
- PID + SV select
- PID + Mathematical Module
- PID + SV select + Mathematical Module
- PID + Input select + Mathematical Module
- Heat/Cool control
- Heat/Cool control with SV select
- Totalization
- Position feedback control
- Servo control



Recipe Function

- The value of the Parameter can be changed synchronizing with the change of the PID Palette.
- 10 Parameters can be registered as a Recipe Parameter for each PID Palette.

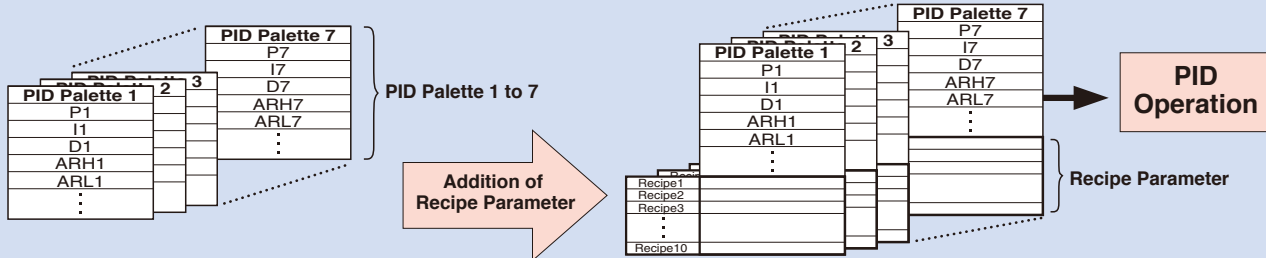

-Plastic Injection Machine.

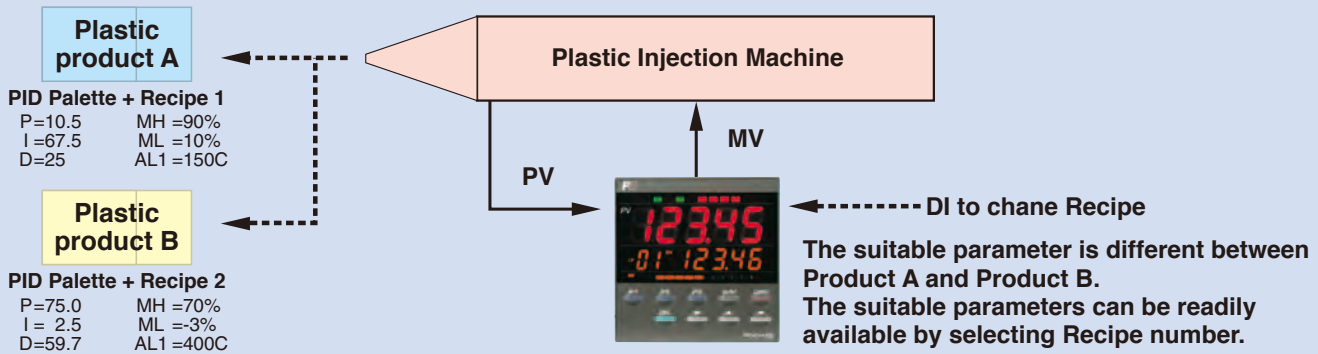

Enhanced Functions

Input Linearize Function

- The Linearize function can be linear converted by using the table of 16 points.
- Linearize function has been added to all analog inputs (PV1,PV2,Ai1).

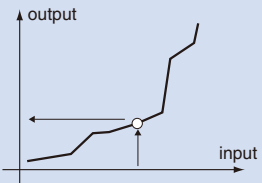

Input block diagram

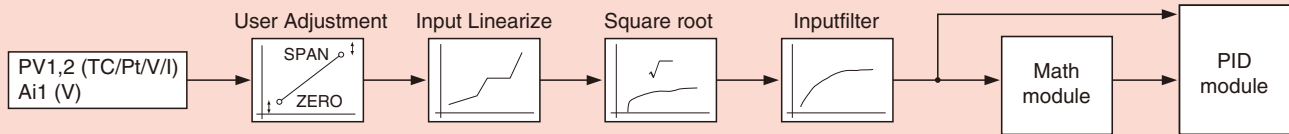

Totalize Function

- Totalize function can be added to all Templates.

Outline of specification

1) Totalized value	-1999999 to 9999999 (7 digits)
2) Totalize source	PV1, PV2, Ai1, AiM
3) Totalize resolution	XXX.XXXX to XXXXXXX
4) Status	RUN / HOLD / RESET
5) Totalized value output	via Re-transmission output
6) Alarm output	via DO1 to DO4
7) Totalized data backup	Backup cycle 30 seconds to EEPROM (No battery equipped)

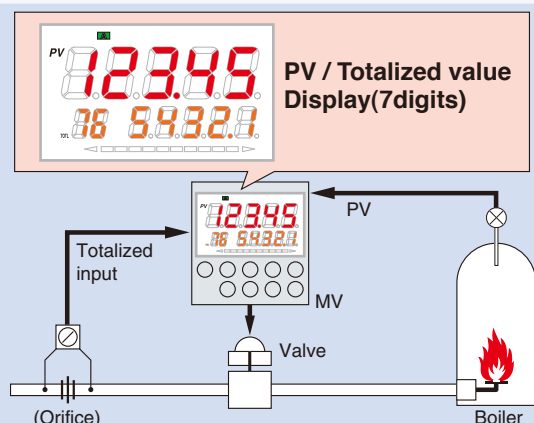

Other powerful features and functions

Mathematical Module (standard feature) The number of expressions are 24 types.

Useful for various applications involving process manipulation, input switching, etc. by the numeric operation between two or three inputs. User defined formulas can be applied to process and analog inputs.

(Data type : Engineering unit with floating decimal point)

Flow compensation, Average, High/Low selector, Input selector and etc.

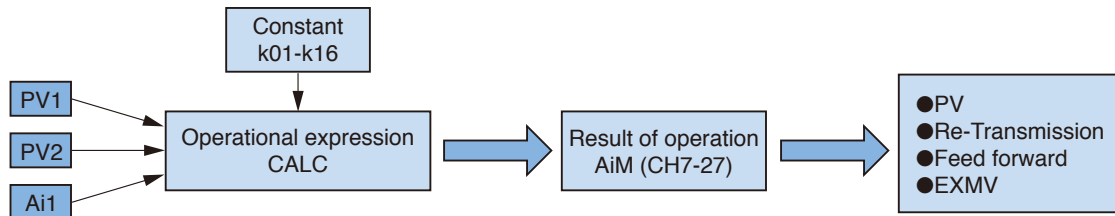

CALC set value	Name of operation	Math function
0	No operation	$AiM = PV1$
1	Expression 1 (Flow rate compensation calculation)	$AiM = k01 \times \sqrt[1]{PV1} \times \sqrt[2]{\frac{Ai1+k02}{k03}} \times \frac{k04}{PV2+k05}$ PV1 : Flow rate (Differential pressure), PV2 : Temperature, Ai1 : Pressure
2	Expression 2 (Flow rate compensation calculation)	$AiM = k01 \times PV1 \times \sqrt[1]{\frac{Ai1+k02}{k03}} \times \frac{k04}{PV2+k05}$ PV1 : Flow rate (Differential pressure), PV2 : Temperature, Ai1 : Pressure
3	Expression 3 (Flow rate compensation calculation)	$AiM = k01 \times PV1 \times \frac{Ai1+k02}{k03} \times \frac{k04}{PV2+k05}$ PV1 : Flow rate (Differential pressure), PV2 : Temperature, Ai1 : Pressure
4	Expression 4	$AiM = \frac{(k01 \times (k02 \times PV1 + k03 \times PV2 + k04 \times Ai1) + k05)}{(k06 \times (k07 \times PV1 + k08 \times PV2 + k09 \times Ai1) + k10)}$
5	Expression 5	$AiM = \frac{(k01 \times ((k02 \times PV1 + k03) \times (k04 \times PV2 + k05) \times (k06 \times Ai1 + k07)) + k08)}{(k09 \times ((k10 \times PV1 + k11) \times (k12 \times PV2 + k13) \times (k14 \times Ai1 + k15)) + k16)}$
6	Expression 6	$AiM = k01 \times PV1 \times (k02 \times PV2 + k03 \times Ai1) + k04 \times Ai1 + k05$
7	H selector, 2 points	$AiM = \text{Max}(PV1, PV2)$ Use either PV1 or PV2 input, whichever is larger, as PV.
8	L selector, 2 points	$AiM = \text{Min}(PV1, PV2)$ Use either PV1 or PV2 input, whichever is smaller, as PV.
9	H selector, 3 points	$AiM = \text{Max}(PV1, PV2, Ai1)$ Use one out of PV1, PV2, or Ai1 input, whichever is largest, as PV.
10	L selector, 3 points	$AiM = \text{Min}(PV1, PV2, Ai1)$ Use one out of PV1, PV2, or Ai1 input, whichever is smallest, as PV.
11	Input switching, 2 points	$AiM = PV1$ when $PV1 \leq k01$, $PV2$ when $PV1 > k01$

*1 Square root extraction cut point can be set at k06.

*2 Square root extraction cut point can be set at k07.

Application example (Math Function)

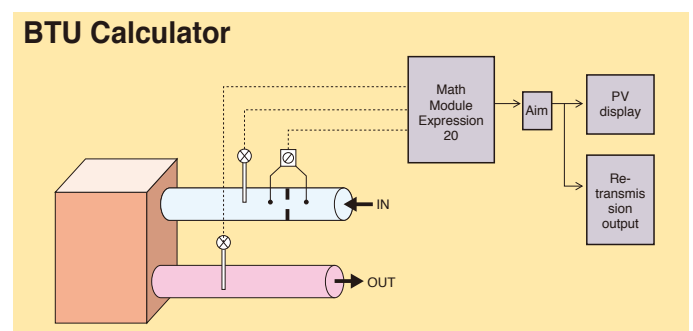
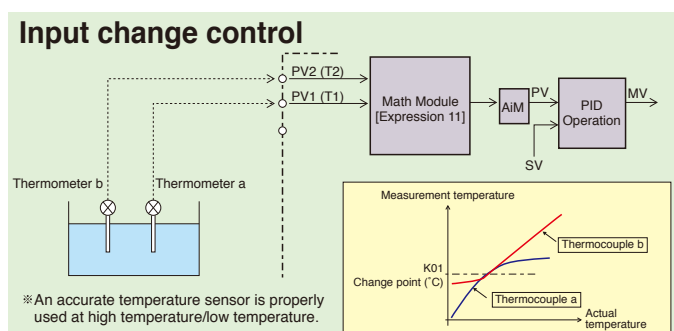
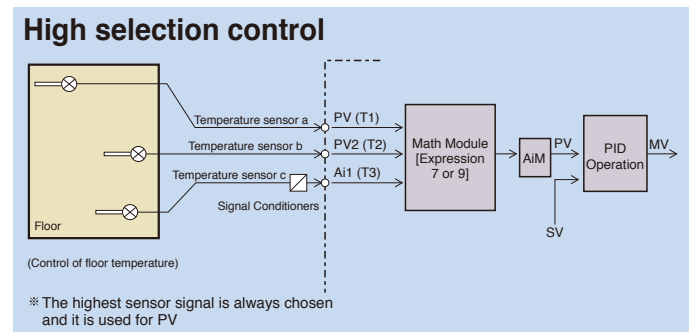
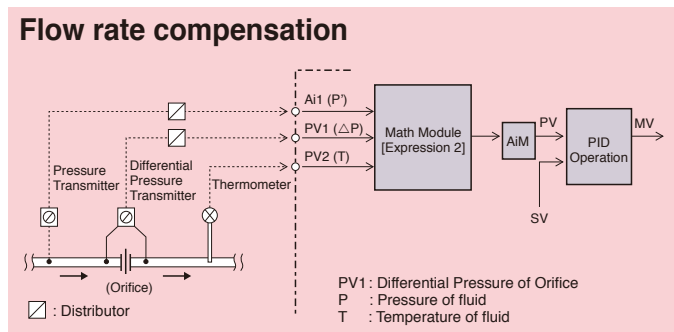



Loader software enables easy parameter-settings

With standard loader software, Parameters can be easily uploaded/downloaded. PID tuning status can be easily viewed on PC.



Connection from standard loader port or from optional RS-485 communication.

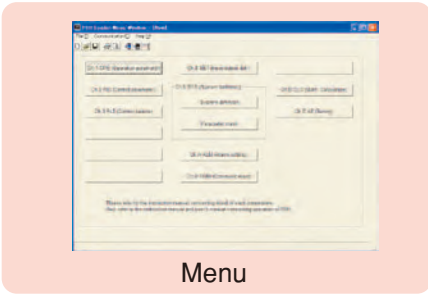

Menu

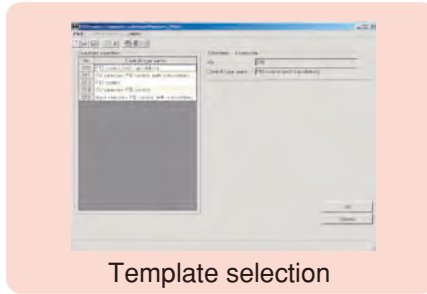

Template selection

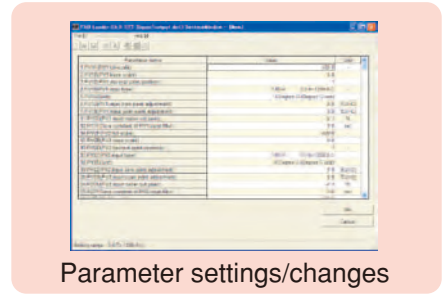

Parameter settings/changes

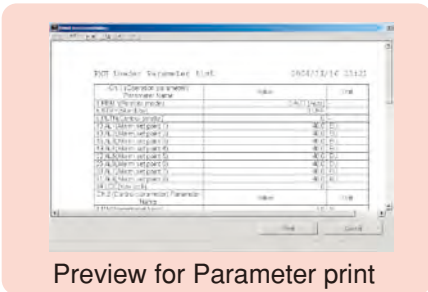

Preview for Parameter print

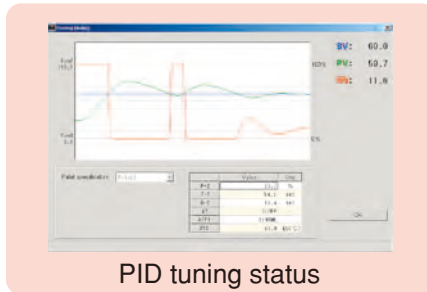

PID tuning status

Small instrumentation system is easily configurable

RS-485 (MODBUS) communication allows for connecting up to 31 units using any general-purpose SCADA software.

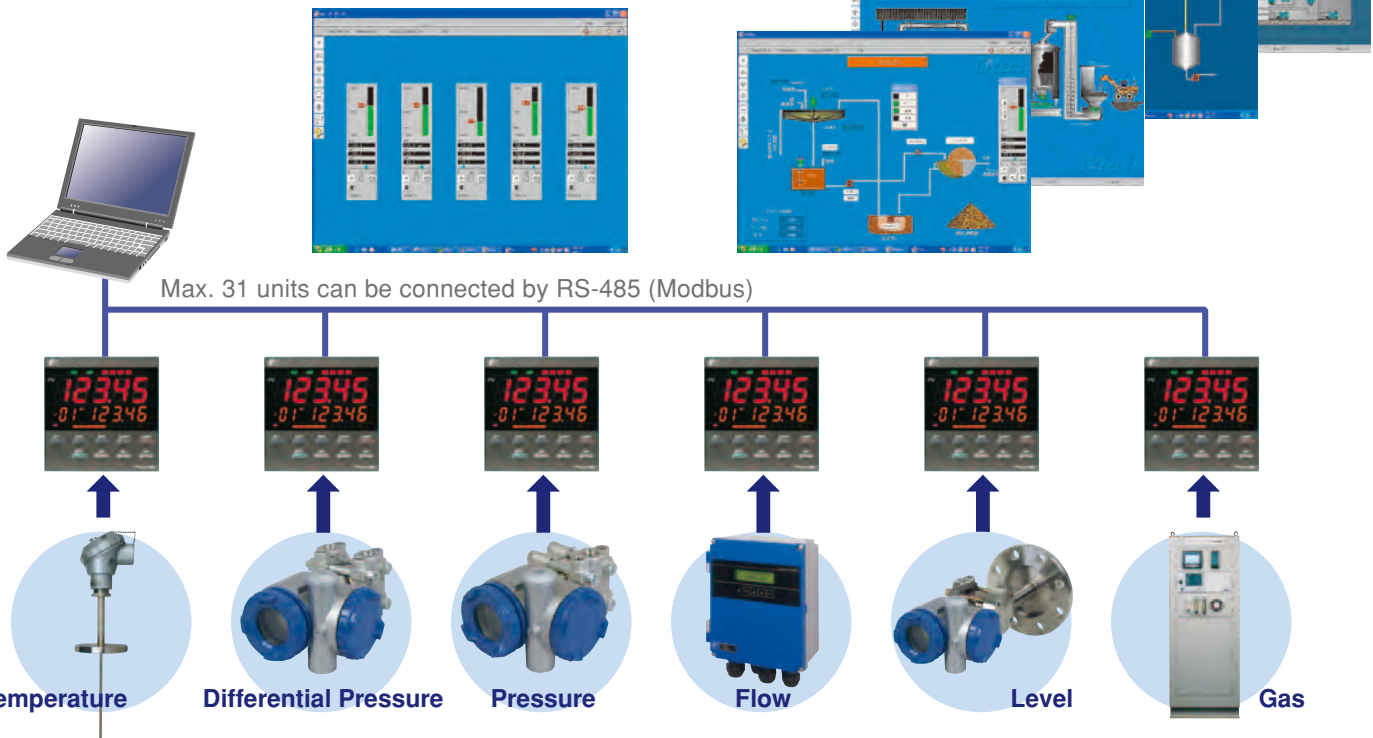

Specifications

General	Size and Mass	96(W)X96(H)X81.5(L)mm, 500g	Output	Control output	One point to be selected from the followings 1. Relay contact output Contact structure : SPDT contact (DO4 is used) Contact rating : AC220V/DC30V, 3A (Resistive load) AC220V/DC30V, 1A (Inductive load) 2. SSR/SSC drive output DC12V (DC10-15V)/Max. current 20mA Load resistance : 600 or more 3. DC4-20mA output Accuracy : 0.2% FS Linearity : 0.2% FS Load resistance : 600 or less
	Power supply	AC100 (-15%) - 240V (+10%), 50/60Hz			
	Power consumption	15VA or less (for AC100V) 20VA or less (for AC220V)			
Input	External terminals	Screw terminal (M3)	Analog re-transmission output	Digital output	Max. 2 points Current output (DC4-20mA) Output type : PV, SV, MV, DV Contact structure : SPDT contact (DO4) SPST contact (other than DO4) Contact rating : AC220V/DC30V, 1A (Resistive load)
	Measuring value input	Sampling cycle : 50ms Input type : Thermocouple, resistance bulb, DC Voltage/Current			
	Auxiliary analog input (option)	Sampling cycle : 100ms Input type DC Voltage (DC1-5V, 0-5V, 0-10V)			
	Digital input	Number of input : 4 or 9 points Specification : Contact or transistor input Contact rating : DC12V, ca.2mA per point			
Function	Valve openings feed back	potentiometer 100-10kΩ	Transmitter power supply	Protocol	DC24V (DC17-30V) Max. current 23mA
	Control method	2-degree-of-freedom PID control with Auto tuning			
	Controller type selection	with application templates			
	Control mode	Auto/Manual Auto/Manual/Remote			
	Alarm output	Max. 9 points as digital output			
Indication	Memory back-up	by nonvolatile memory	RS232C communication	Protocol	Modbus-RTU
	Accuracy	0.1%1digit of full scale			
	PV indicator	LED 7 segments 5 digits (red color), character height: 20mm			
	SV indicator	LED 7 segments 5 digits (orange color), character height: 13mm			
	Status indicator	LED 7 segments 2 digits (orange color), character height: 12mm			
	Bargraph	LED 12 segments (orange color)			
Mode indicator	Stand-by, Control mode, output, alarm	RS485 communication (Option)	Speed	9600bps, 19200bps, 38400bps	
			Applied standards	UL, CE Mark	

Ordering code

Digit	Description	PXH	4	5	6	7	8	9	10	11	12	13
			9				1	-	V			0
4	<Size> 96x96mm		9									
5	<Control loop function> 1 loop, PID controller 1 loop, Heating/cooling control 1 loop, Motorized valve control output with PFB 1 loop, Motorized valve control output without PFB			A F D S								
6	<PV input> Universal input, 1 point Universal input, 2 points	Note 1			1 2							
7	<Auxiliary input> None DC voltage	Note 2				0 1						
8	<Version>						1					
9	<Output 1> Current Current Current Current SSR/SSC drive SSR/SSC drive SSR/SSC drive	<Output 2> None Current SSR/SSC drive Transmitter power supply None Current SSR/SSC drive						1 2 3 5 A B C				
10	<Power supply> 100 to 240 V AC 50/60Hz								V			
11	<Communication interface> None RS-485 (Modbus) T-Link	Note 3								O R T		
12	<Digital input> 4 points (DI1 to 4) 4 points (DI1 to 4) 9 points (DI1 to 4, 11 to 15)	<Digital output> including control output relay output 2 points (DO3, 4) 4 points (DO1 to 4) 9 points (DO1 to 4, 11 to 15)	Note 4									O A B
		Note 1										

Note 1) The 6th digit "2" is not available with 12th digit "B".
 2) 5th digit "D" is not available with 7th digit "1".
 3) 6th digit "2" or 12th digit "B" is not available with 12th digit "T".
 4) DO4 is used for Relay contact as control output.

External dimensions (Unit : mm)

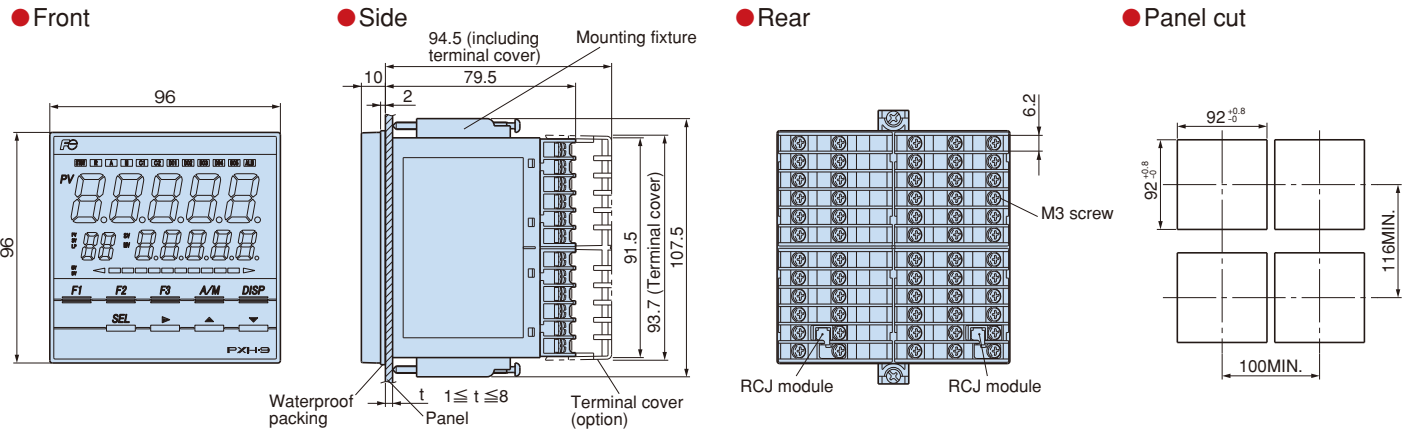

Scope of supply

Controller PXH, mounting fixture, waterproof packing for front face, engineering unit sheet, instruction manual, termination resistor in case communication interface is ordered.

⚠ Precautions for use
 To ensure temperature process safety in case of PXH's failure, fit a separate over-temperature protection unit to isolate the heating circuit. Uncontrollability due to such failure may cause major accident.

Fuji Electric Co., Ltd.

International Sales Div.
 Sales Group
 Gate City Ohsaki, East Tower, 11-2, Osaki 1-chome,
 Shinagawa-ku, Tokyo 141-0032, Japan
<http://www.fujielectric.com>
 Phone: 81-3-5435-7280, 7281 Fax: 81-3-5435-7425
<http://www.fujielectric.com/products/instruments/>